

playmobil®
6111



WARNING:
CHOKING HAZARD

Small parts. Not for children under 3 years.

”Ne concerne que les USA“

Wichtige Unterlagen, bitte sorgfältig aufbewahren !
Important: Please keep these instructions for future reference !
Documents importants, à conserver soigneusement !
Belangrijke documenten, bewaar deze zorgvuldig !



www.playmobil.com

1

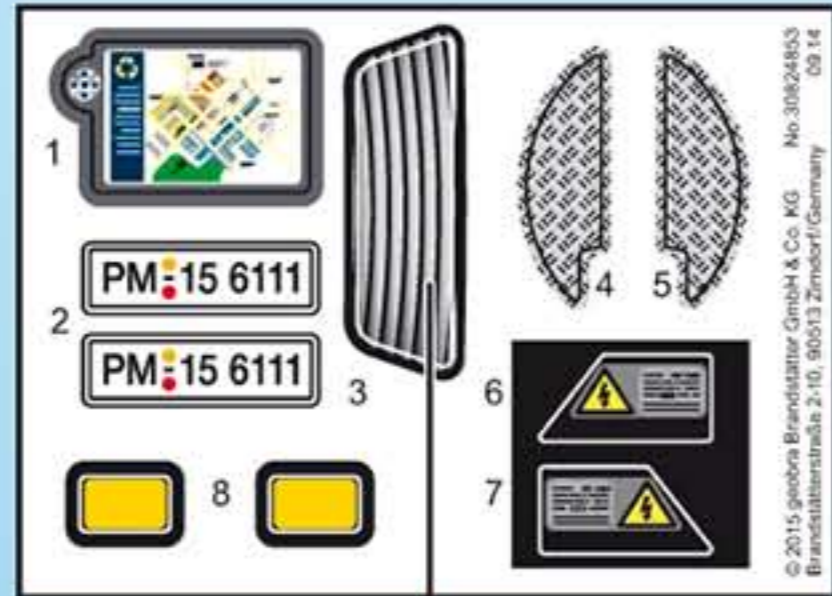

30 82 4853

30 23 0523

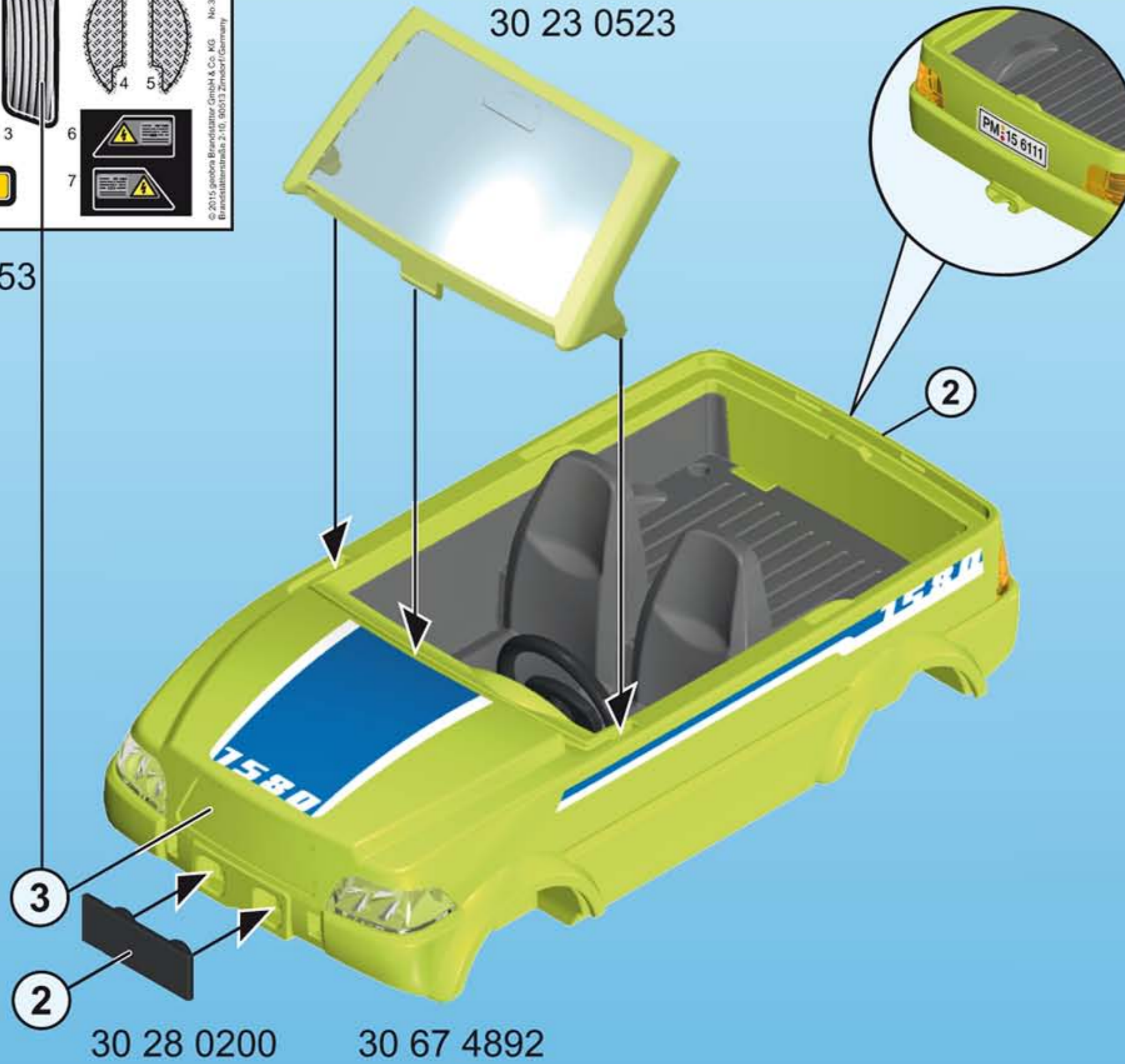

2

2

4x

1

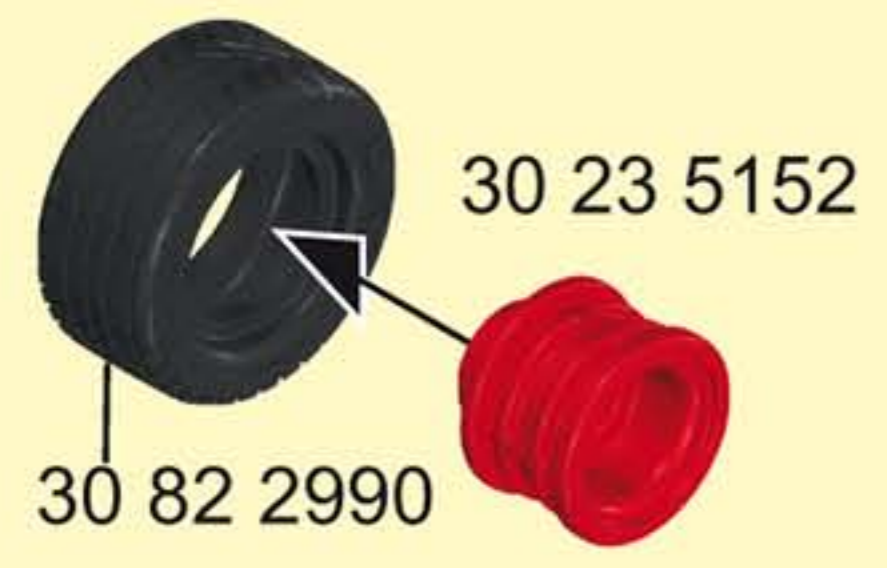

2

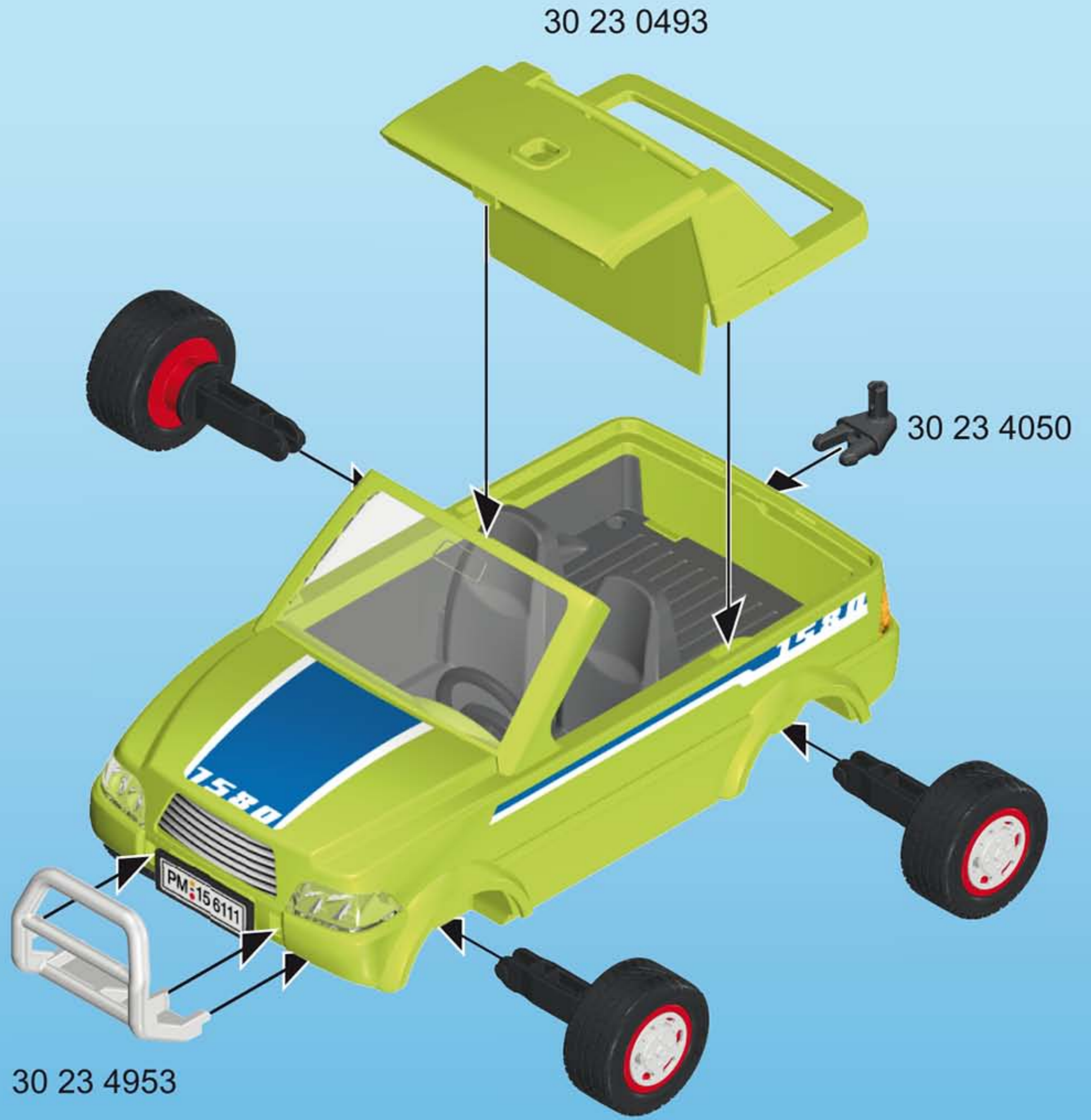

3

3

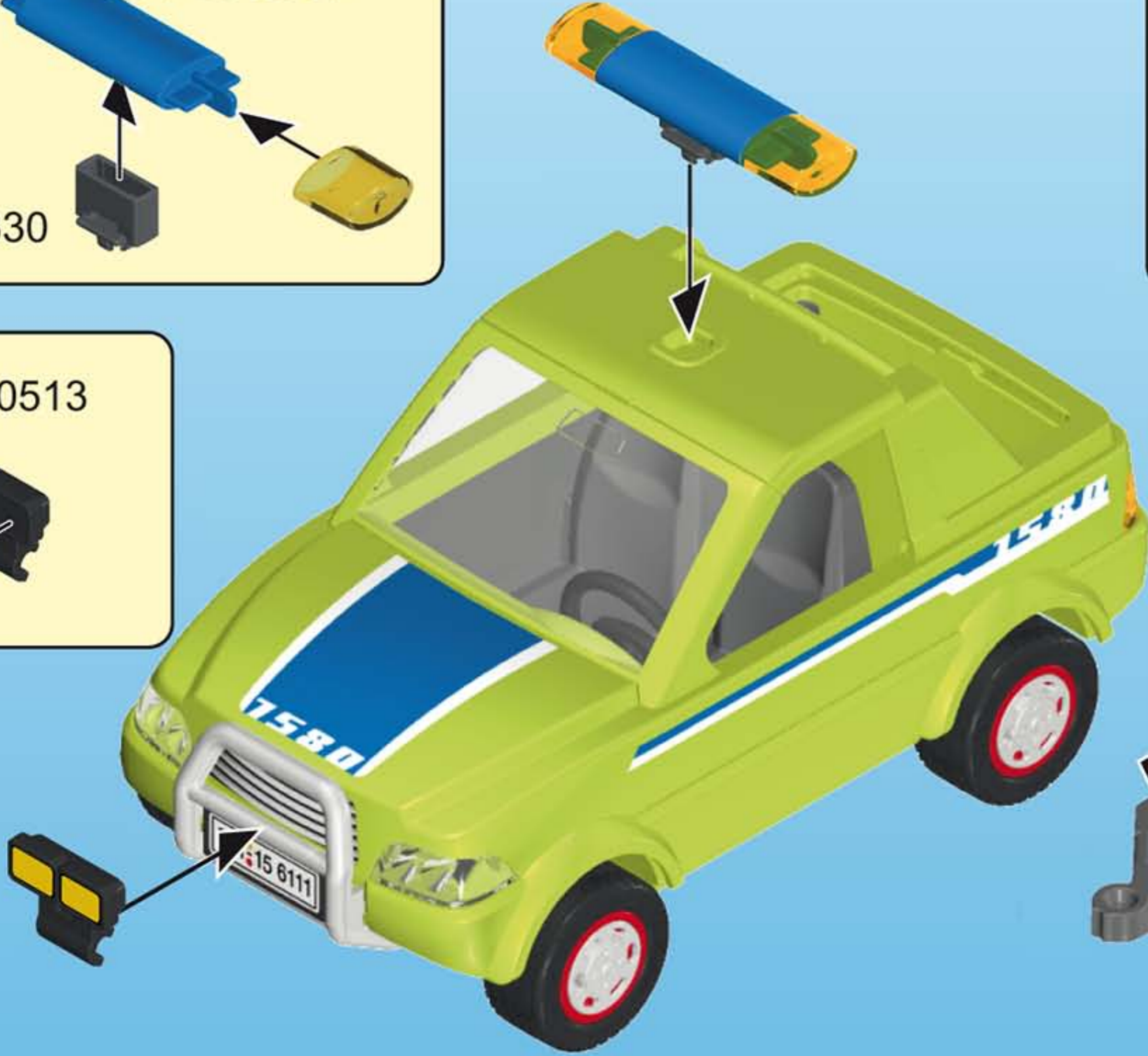
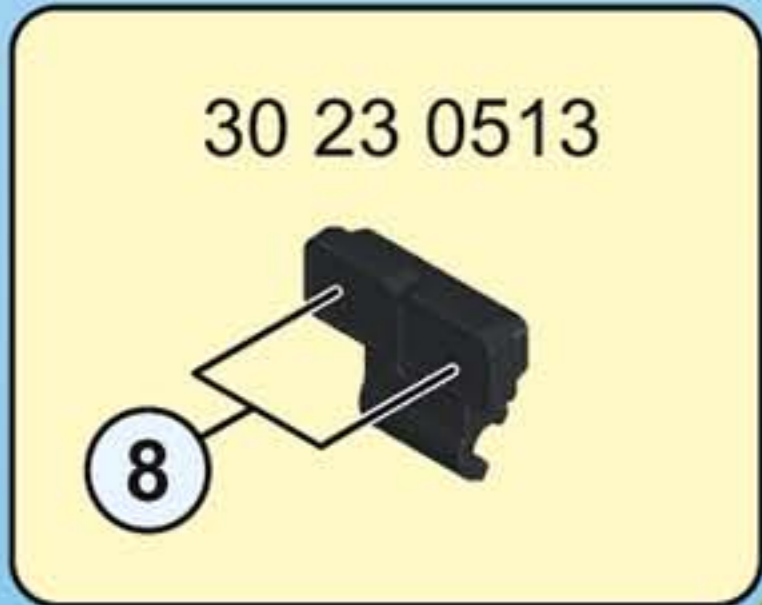
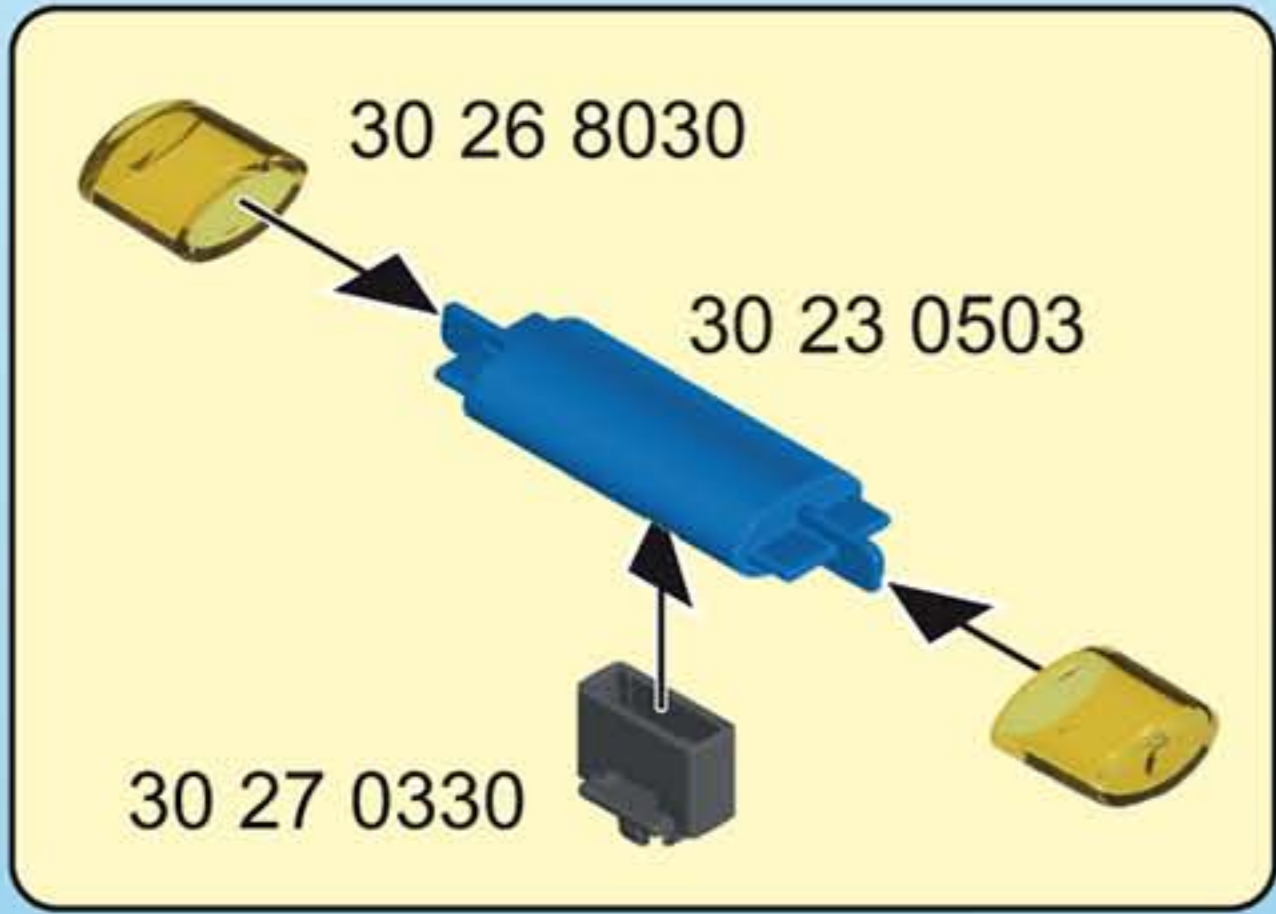

4

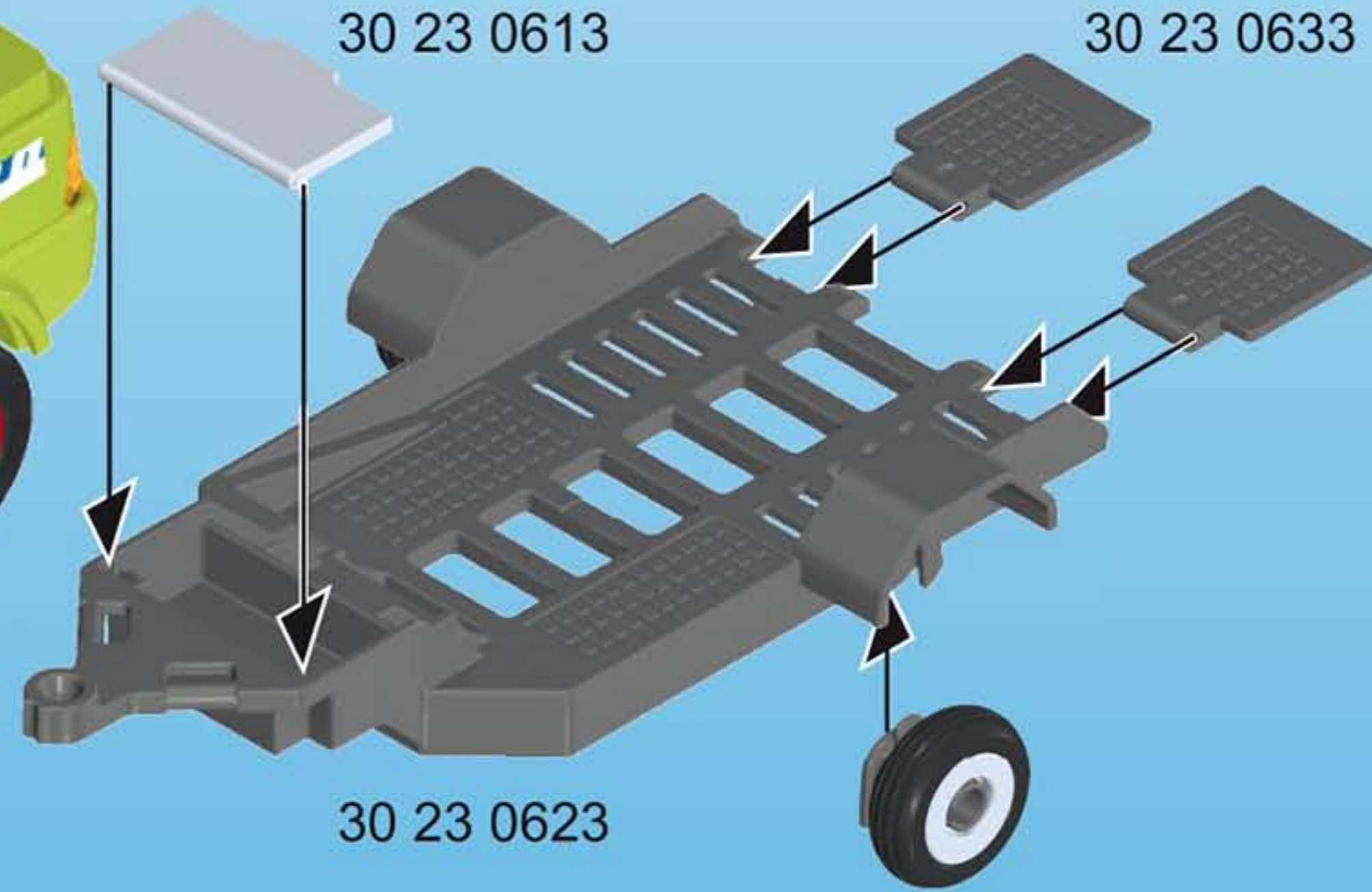
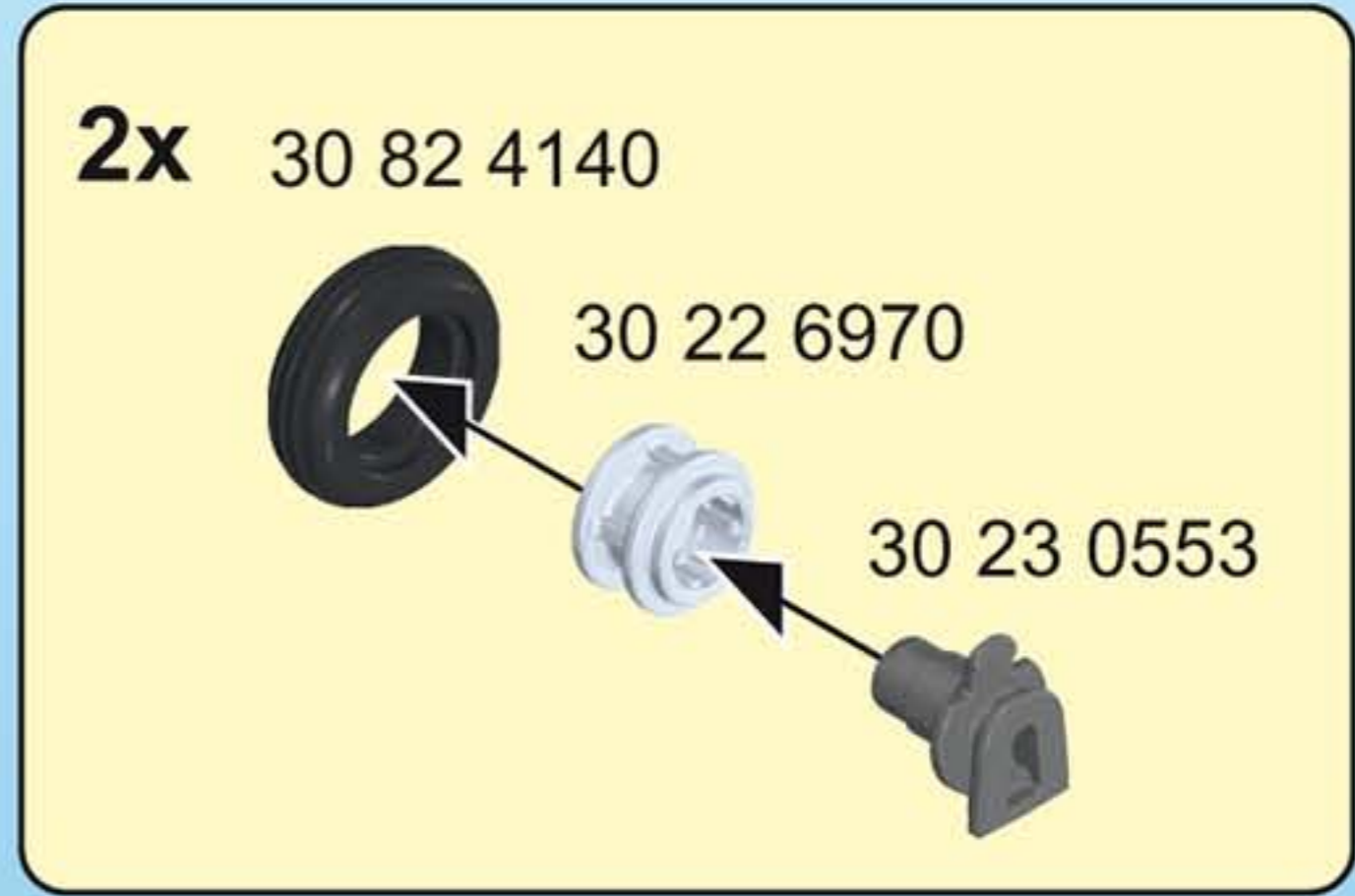

4

1

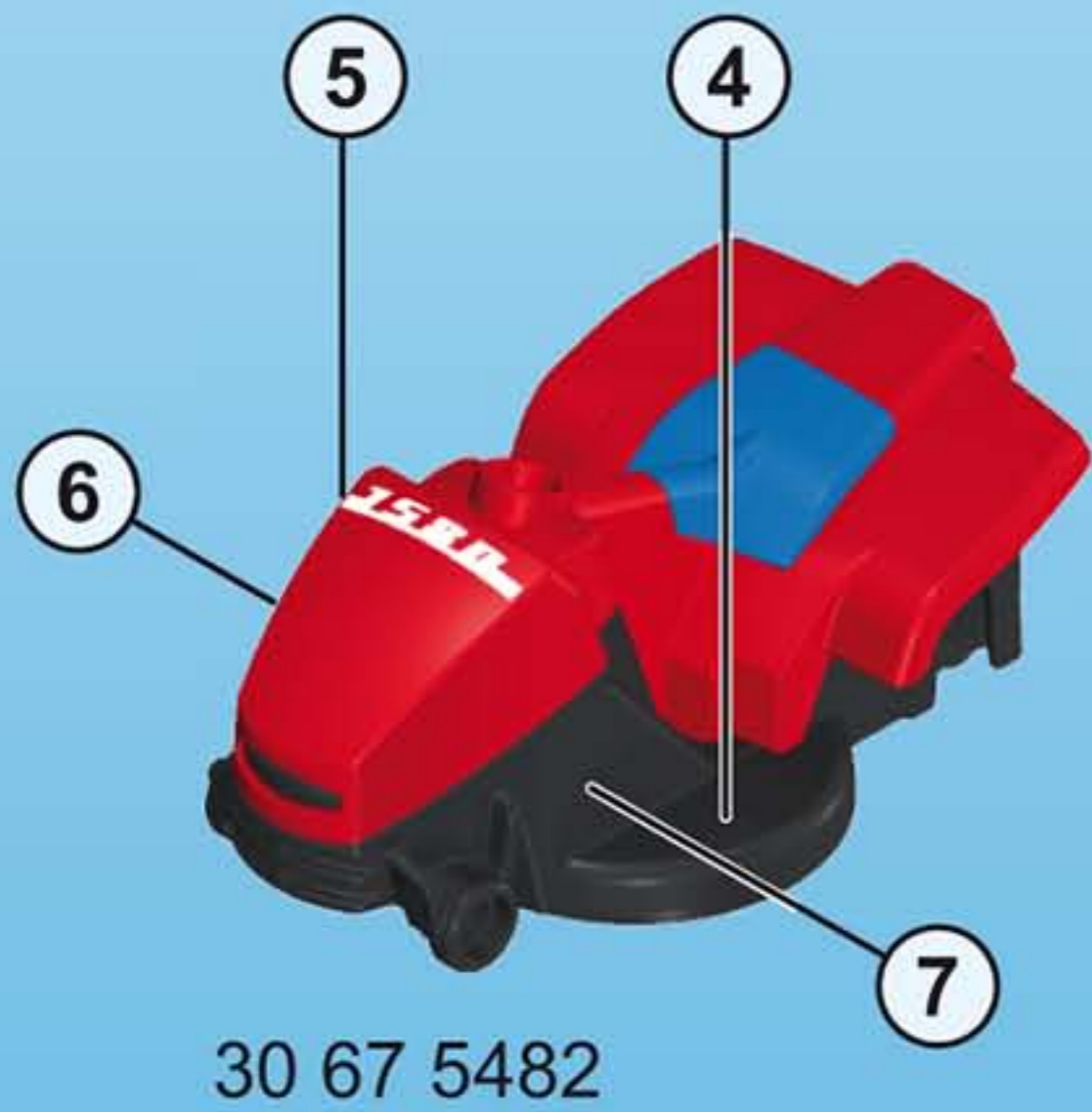
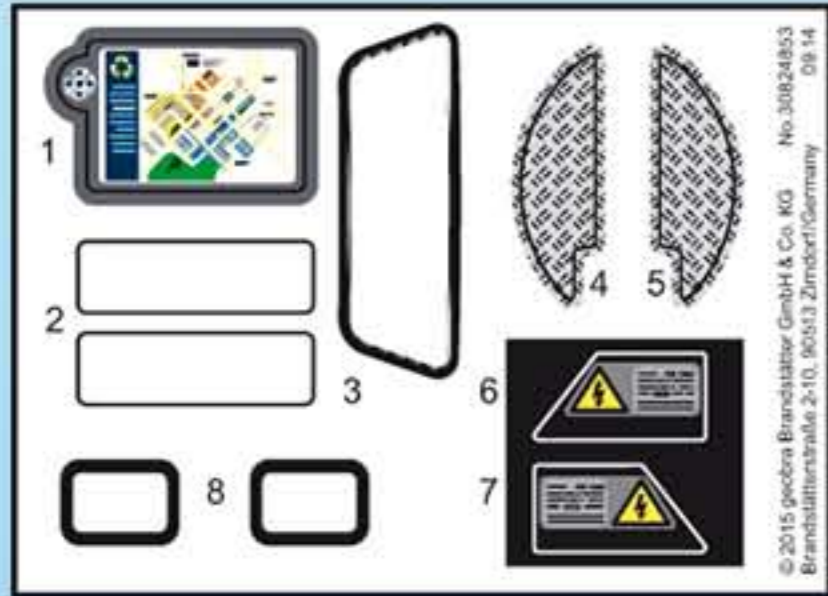

2

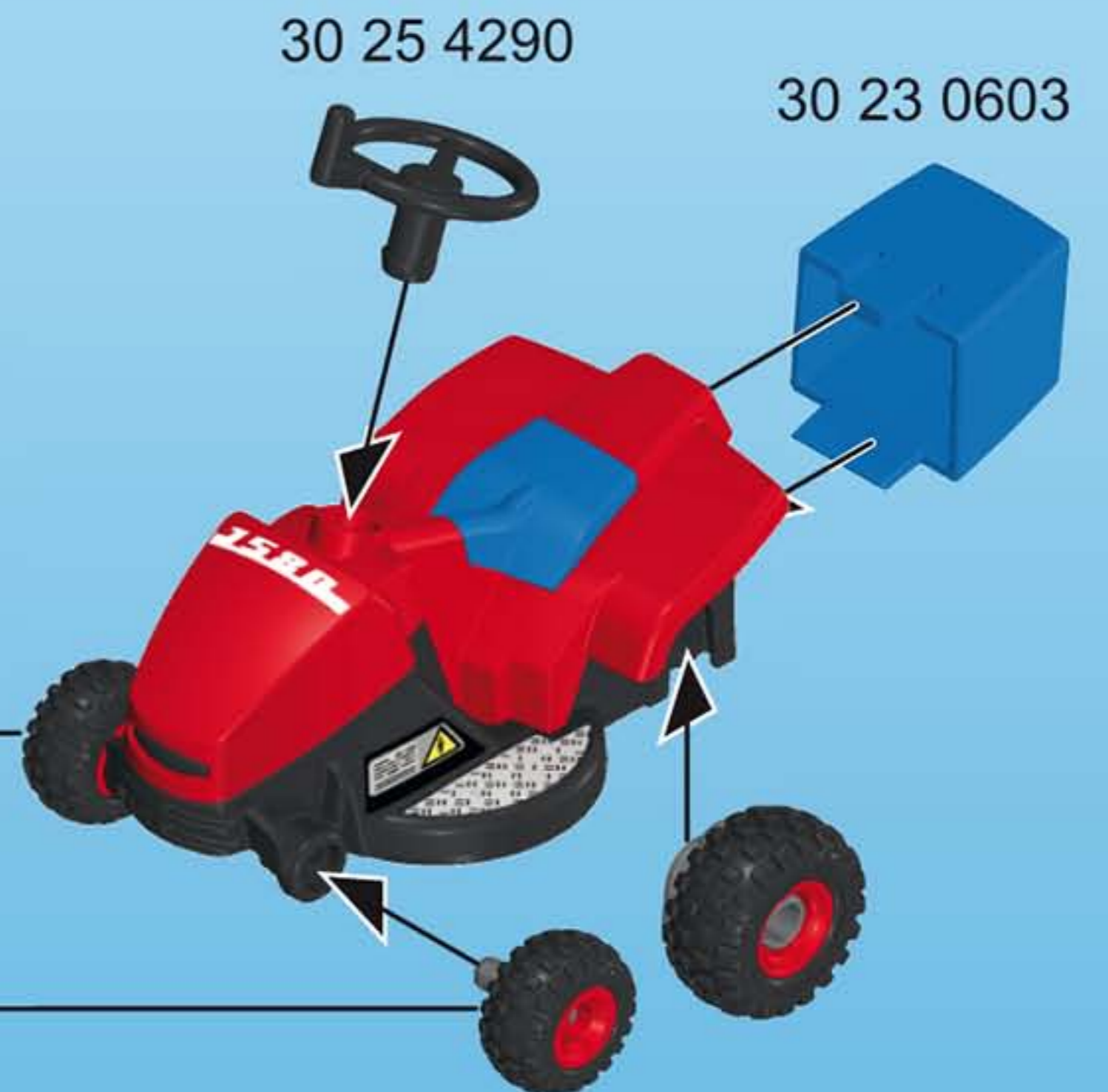
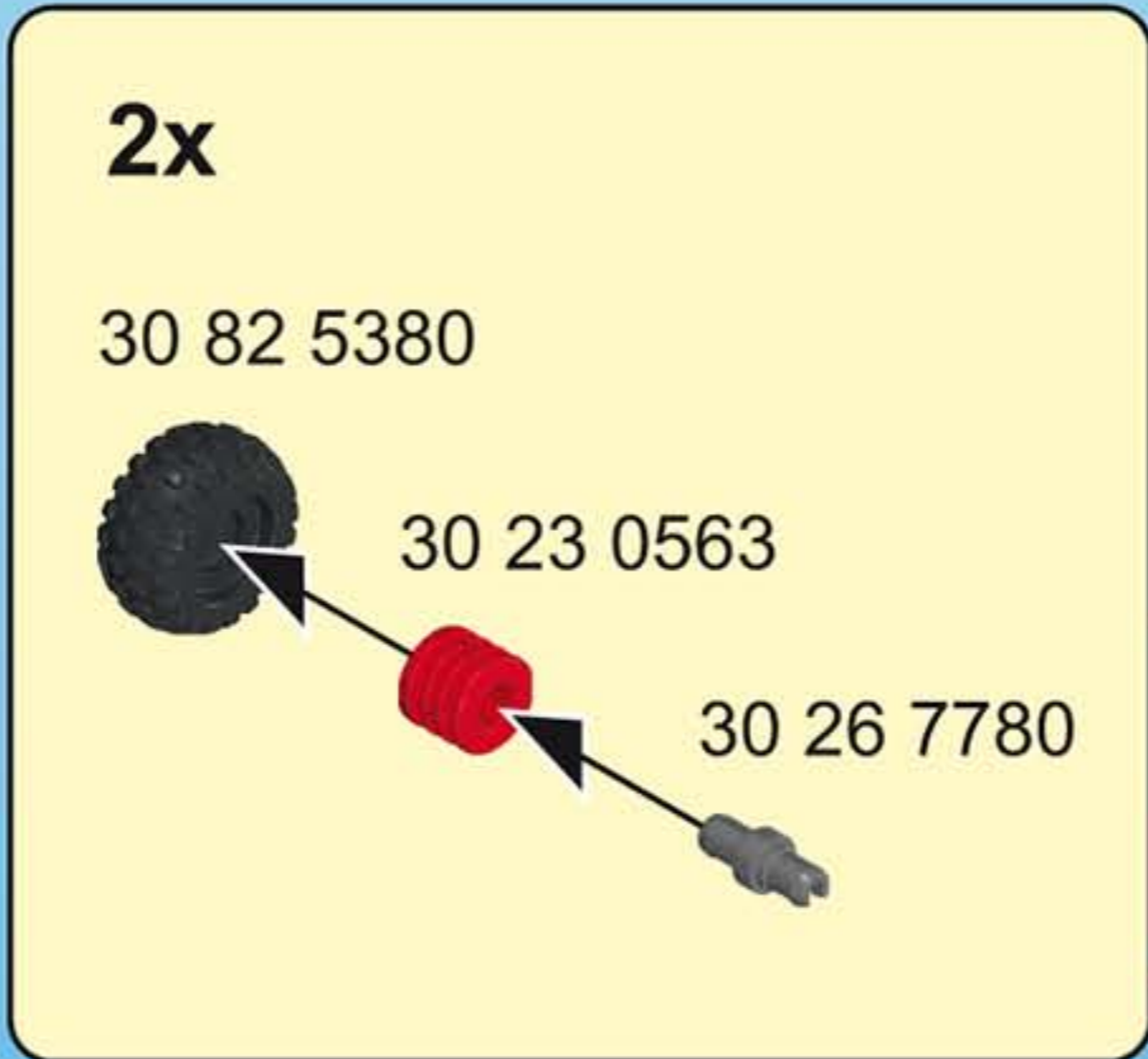
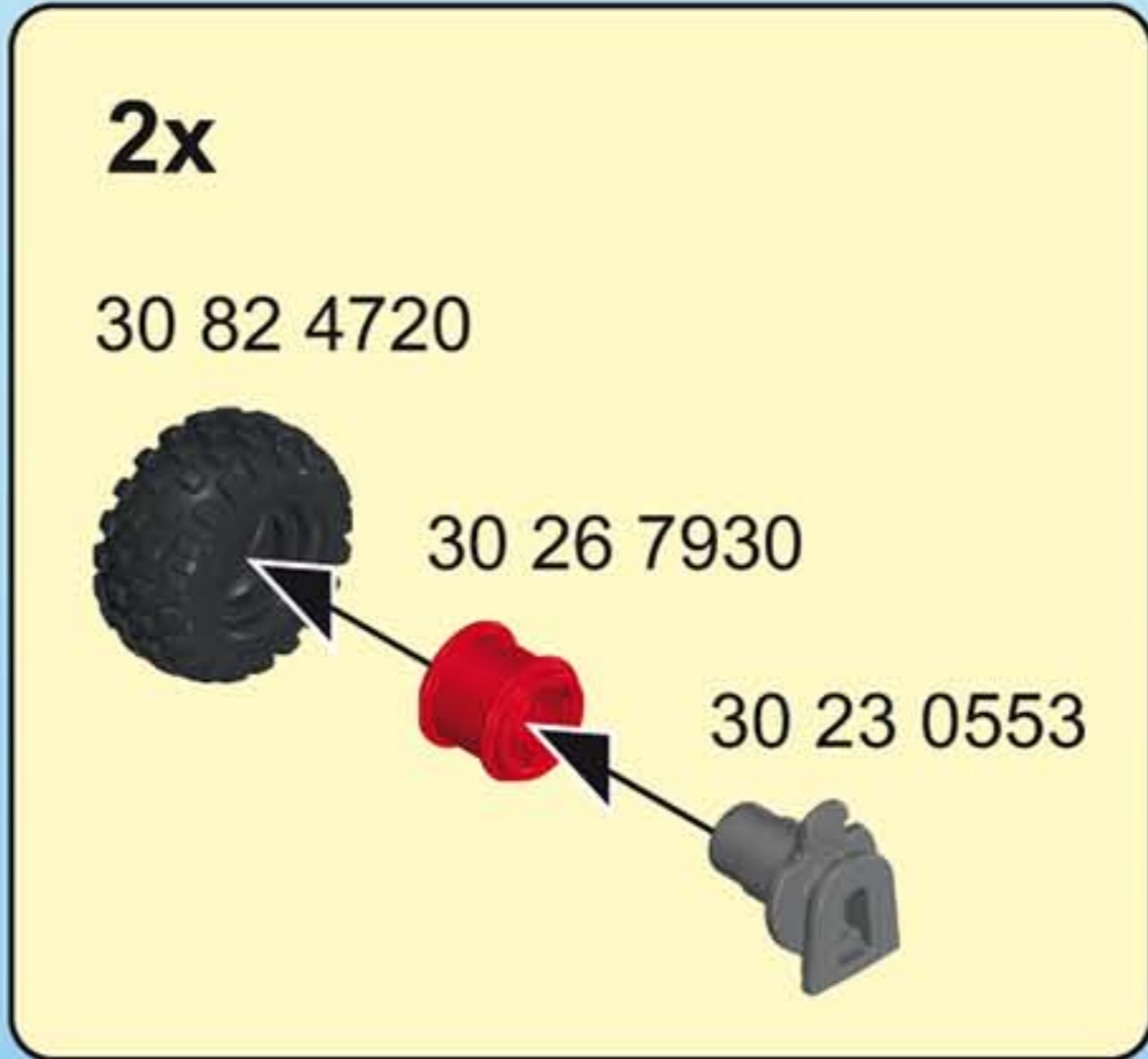

5

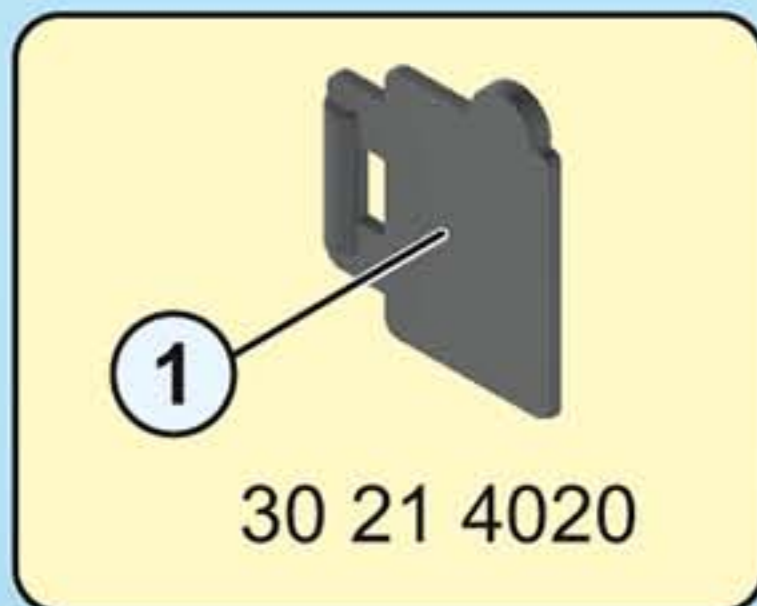

30 26 5000



2x 30 08 3200



30 00 5133



30 23 0483



30 23 0473



30 23 0463

Serviceadressen finden Sie in allen Playmobil-Prospekten

Addresses of Customer Service Departments are shown in all Playmobil catalogues

L'adresse du service consommateurs est indiquée dans tous les catalogues Playmobil

Troverete gli indirizzi dei centri di assistenza in tutti i cataloghi Playmobil

In alle PLAYMOBIL catalogi vindt u het adres van onze klantendienst.

Las Direcciones de los Departamentos de Servicio al Consumidor se encuentran en todos los catálogos Playmobil

Η διεύθυνση του Γραφείου Εξυπηρέτησης Καταναλωτών PLAYMOBIL βρίσκεται σε όλους τους καταλόγους PLAYMOBIL.

pronounce: plāy-mō-bēēl

© 2014 geobra Brandstätter Stiftung & Co.KG
Brandstätterstr. 2-10
90513 Zirndorf, Germany.
No. 30 82 6793 02.16