

**playmobil®**

5950

Wichtige Unterlagen, bitte sorgfältig aufbewahren!  
Important documents keep carefully!  
Documents importants conservez avec soin!  
Belangrijke documenten, bewaar deze zorgvuldig!



**WARNING:**  
**CHOKING HAZARD**

Small parts. Not for children under 3 years.

"Ne concerne que les USA"



7350

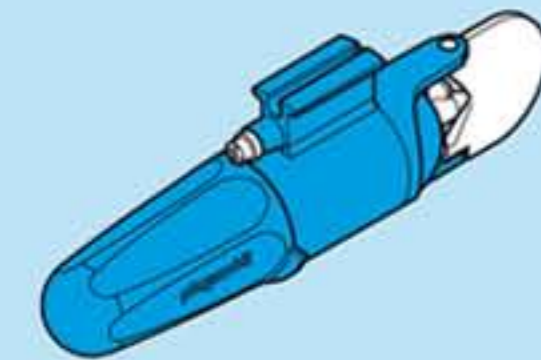

- Nachrüstbar mit Unterwassermotor
- Refittable with underwatermotor
- Moteur submersible, vendu séparément, s'adapte sur ce bateau

1

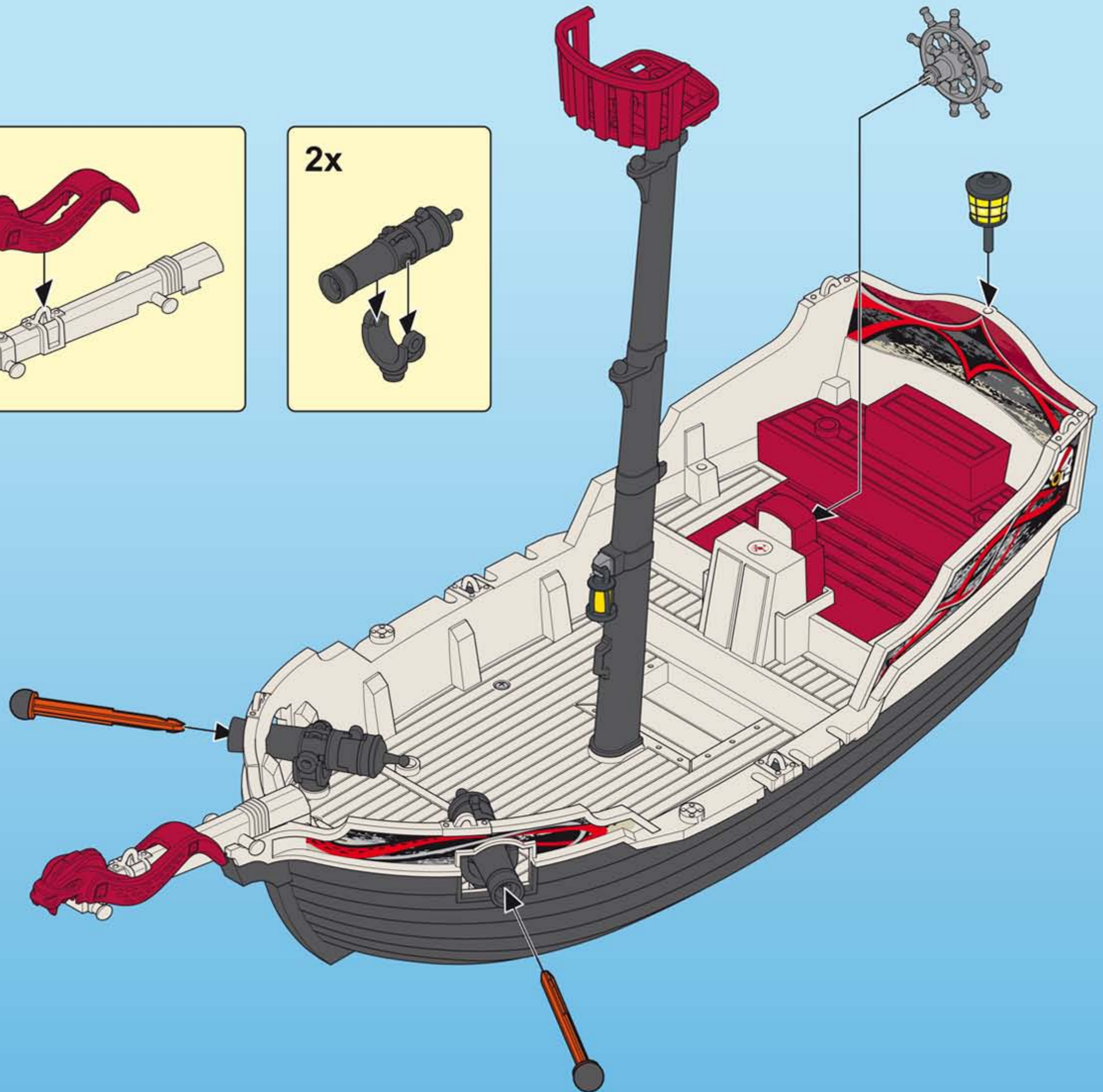
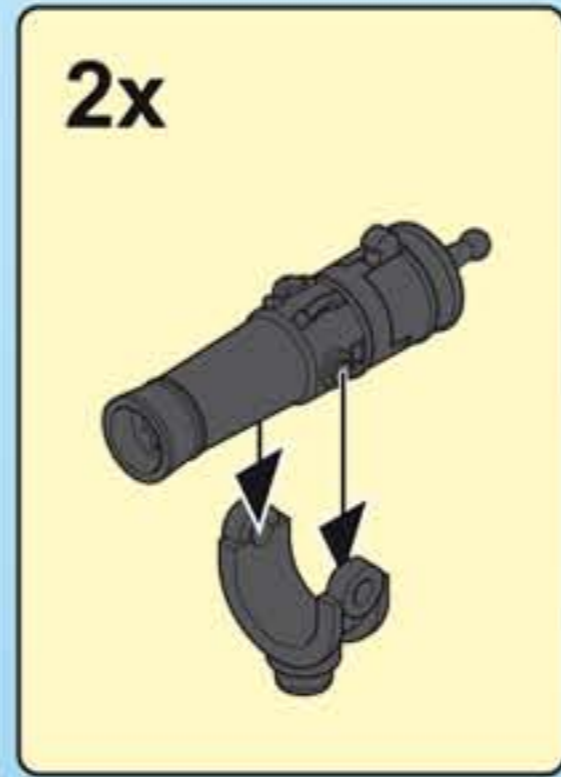
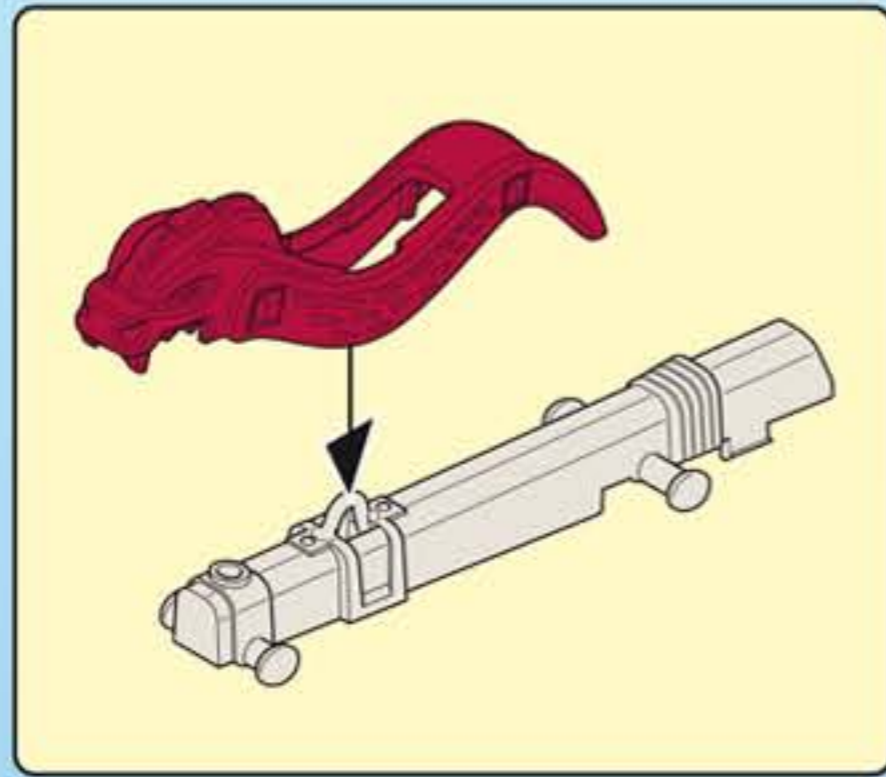
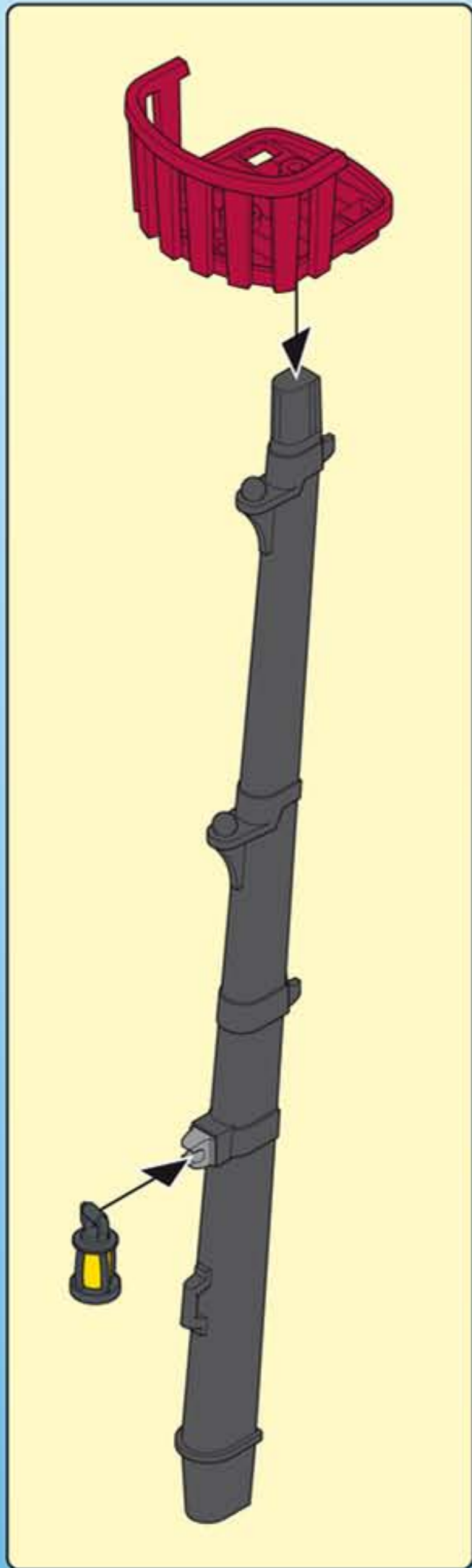

2

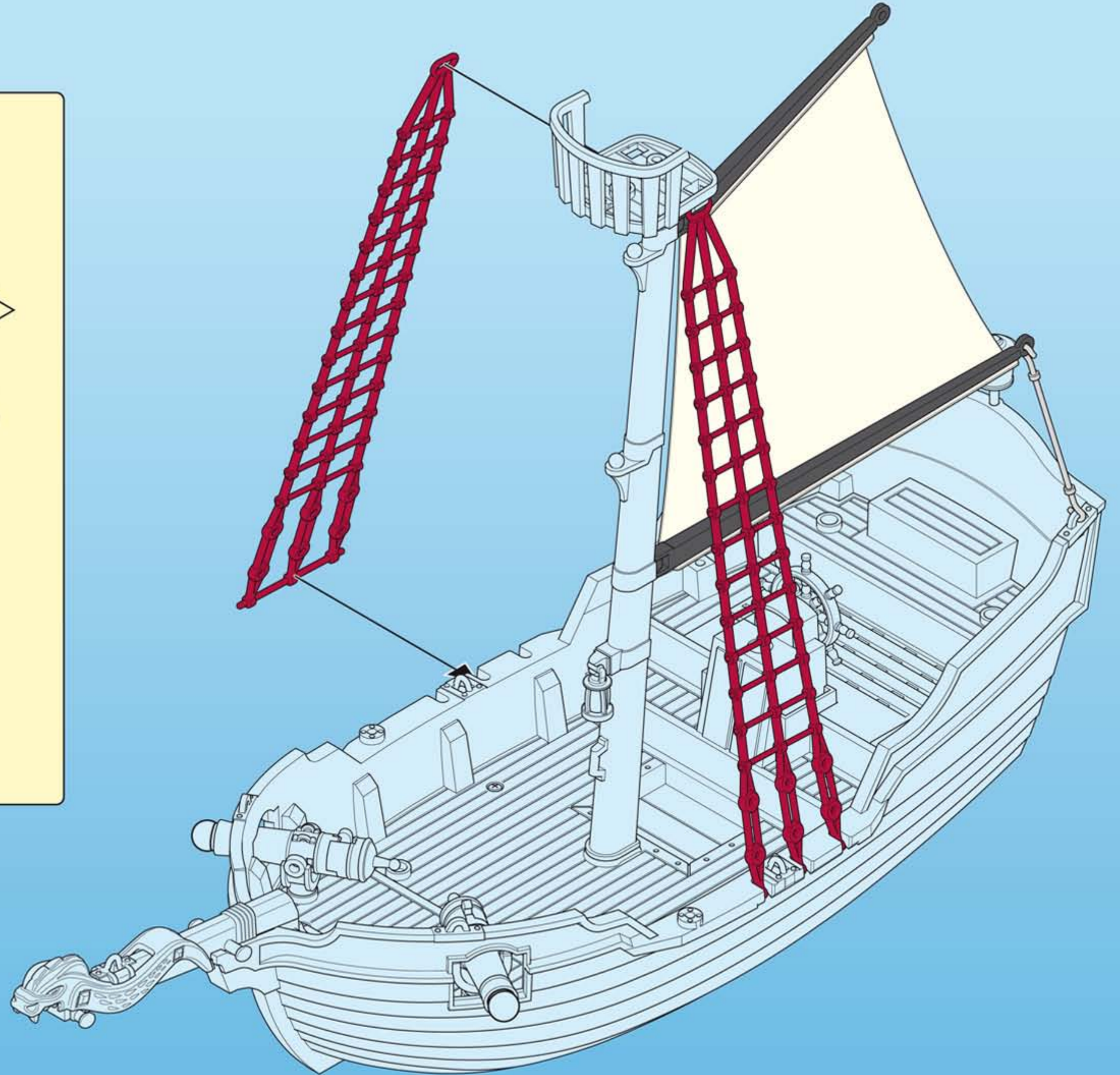
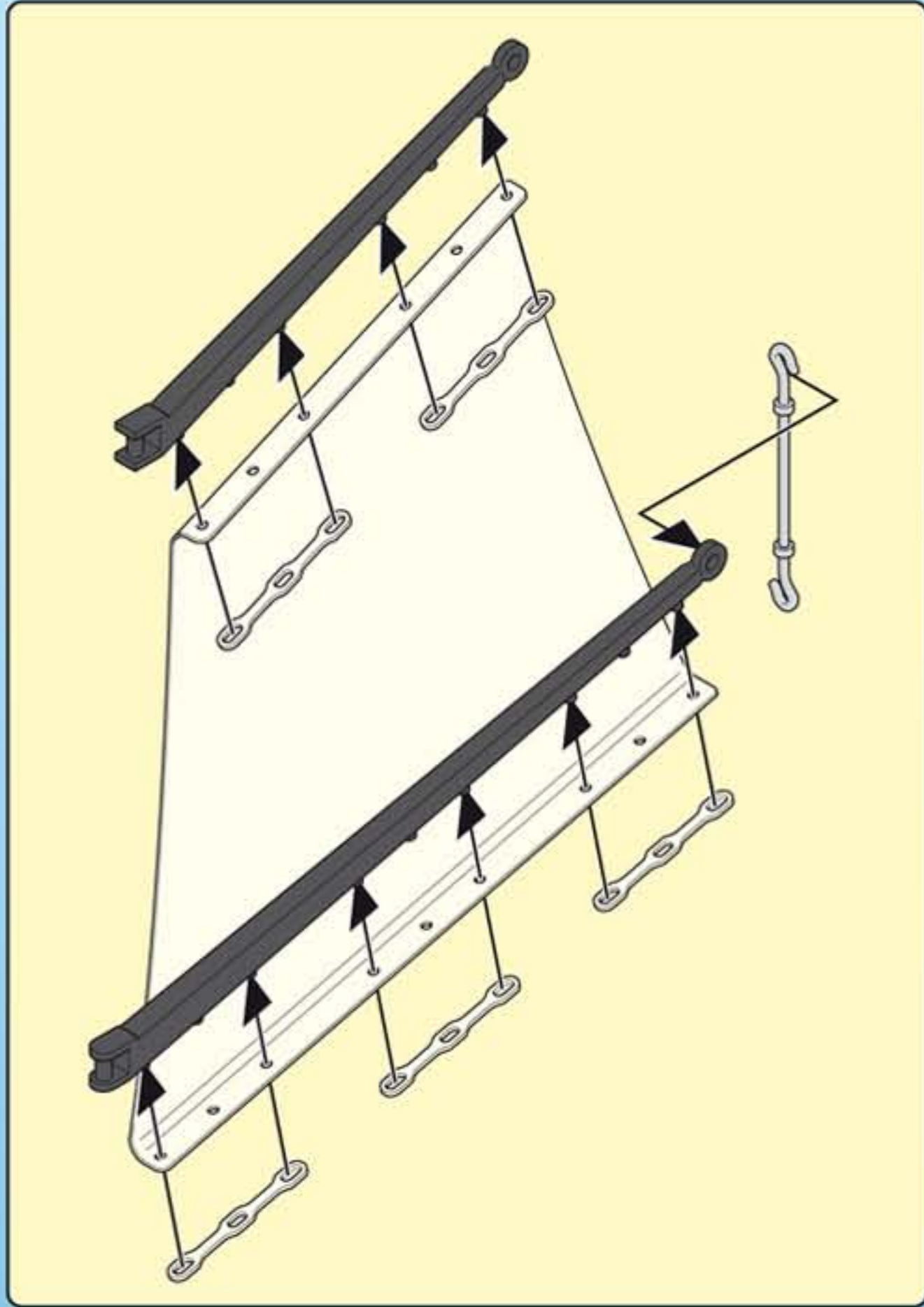

3

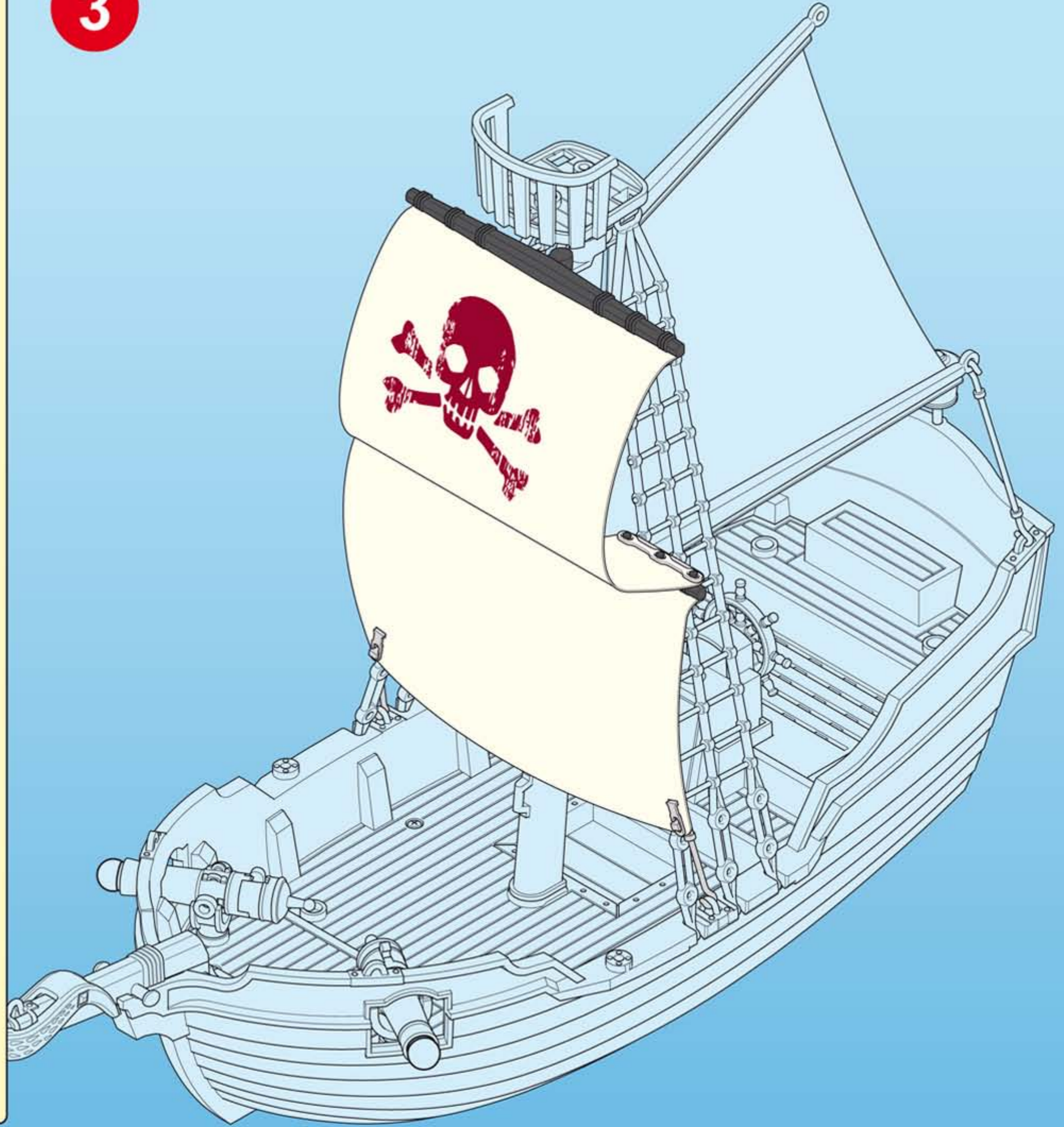
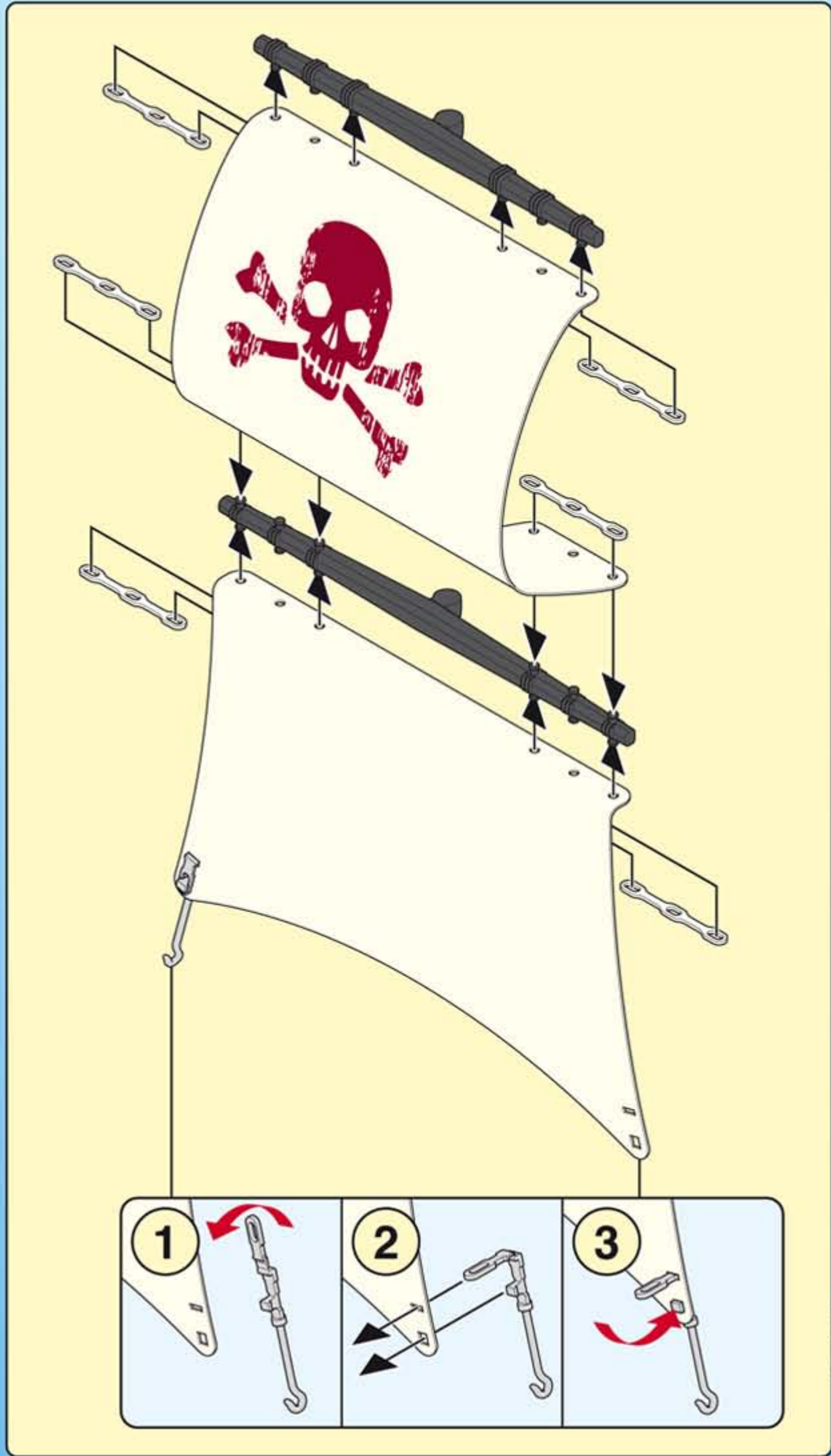

4

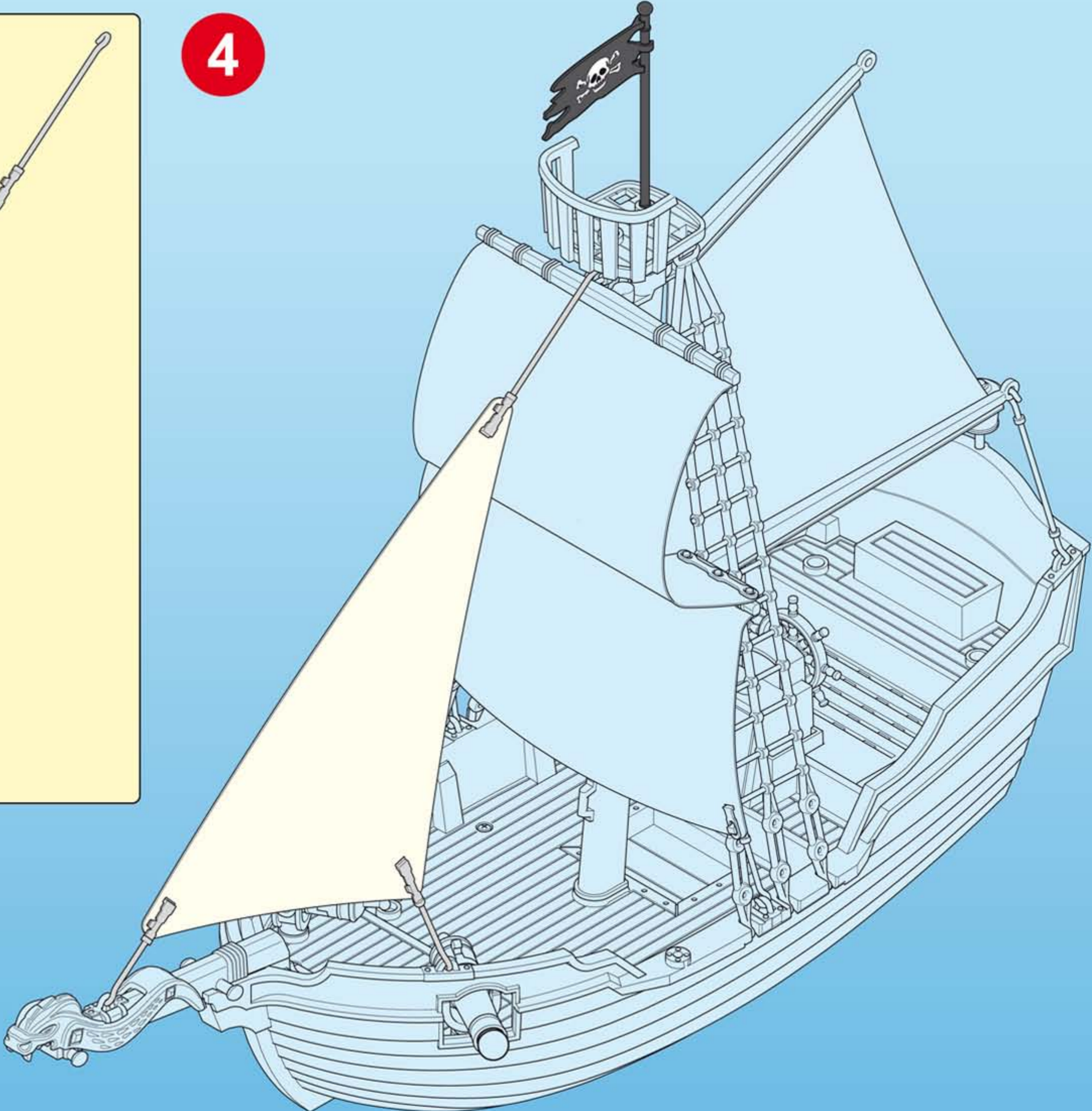
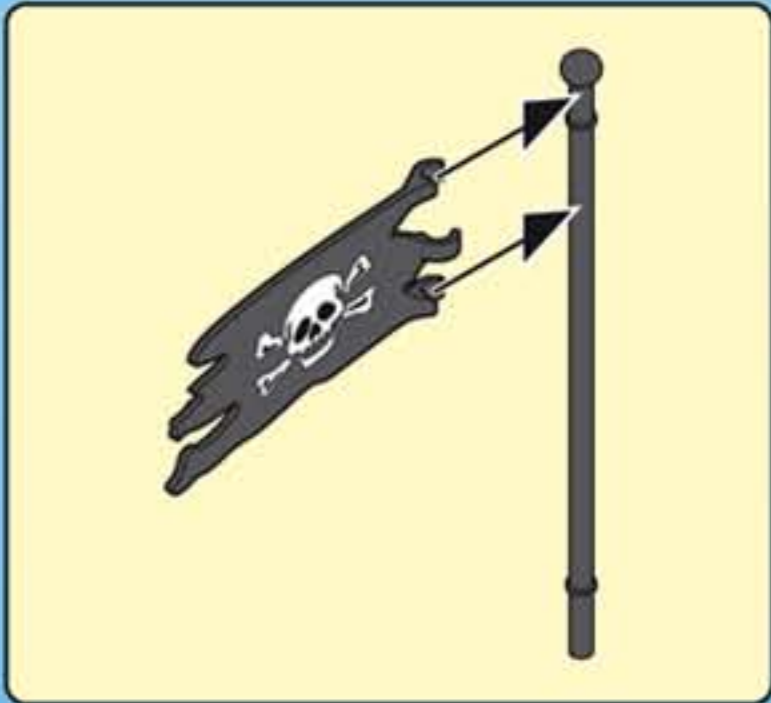
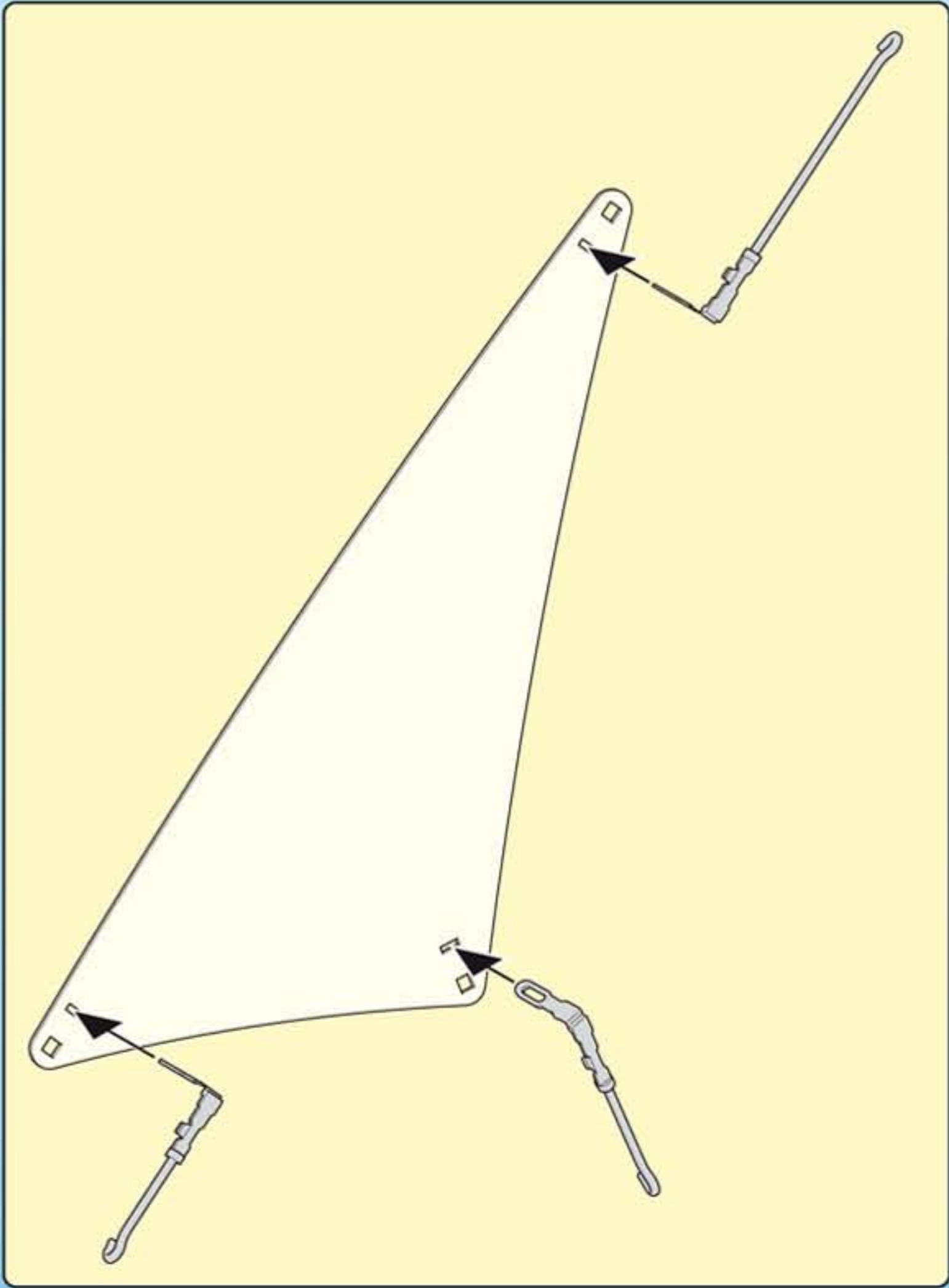

**D A CH L B ACHTUNG!**

- Nur unter Aufsicht und nur in flachem Wasser benutzen.
- Nur mitgelieferte PLAYMOBIL Geschosse verwenden. Nicht auf Augen oder Gesicht zielen.

**USA GB CDN M IRL WARNING!**

- Only to be used in water in which the child is within depth and under supervision
- Only use the PLAYMOBIL projectiles supplied. Do not aim at eyes or face.

**F CDN B L CH ATTENTION!**

- À n'utiliser qu'en eau où l'enfant a pied et sous surveillance.
- Seulement utiliser les projectiles PLAYMOBIL fournis. Ne pas viser les yeux ou le visage

**E MEX i ADVERTENCIA!**

- Se deberá utilizar solamente en el agua, donde el niño haga pie y bajo vigilancia.
- Utiliza únicamente los proyectiles PLAYMOBIL suministrados. No se ha de apuntar a los ojos ni a la cara.

**NL B WAARSCHUWING!**

- Alleen gebruiken onder toezicht, in water waarin het kind kan staan.
- Uitsluitend meegeleverde PLAYMOBIL delen gebruiken. Niet op ogen of gezicht richten.

**I CH ATTENZIONE!**

- Utilizzare solo in acque dove il bambino tocca con i piedi e sotto sorveglianza.
- Usare soltanto i proiettili PLAYMOBIL in dotazione. Non mirare agli occhi o al viso.

**P AVISO!**

- Utilizar apenas em águas em que a criança tenha pé e sob vigilância.
- Usar apenas os projécteis PLAYMOBIL juntamente fornecidos. Não apontar para os olhos ou face.

**DK ADVARSEL!**

- Må kun anvendes under opsyn og på vanddybder, hvor barnet kan bunde.
- Anvend kun de medfølgende PLAYMOBIL projektiler. Sigt ikke mod øjne eller ansigt.

**N ADVARSEL!**

- Skal kun brukes i vann som ikke er for dypt for barnet, og der barnet er under tilsyn.
- Benytt kun PLAYMOBIL prosjektil som leveres med. Sikt ikke på ansikt eller øyne.

**S FIN VARNING!**

- Får endast användas på grunt vatten och under uppsikt av vuxen.
- Använd endast medlevererade PLAYMOBIL-skott. Sikta ej mot ögonen eller ansiktet.

**FIN VAROITUS!**

- Käytetään ainoastaan matalassa vedessä, jossa lapsi voi seistä ja on aikuisen valvonnassa.
- Käytä vain mukana toimitettuja PLAYMOBIL-ammuksia. Älä tähtää päin silmiä tai kasvoja.

**H FIGYELMEZTETÉS!**

- Mély vízben nem használható! Kérjük, kizárólag szülői felügyelettel használja kis vízben!
- Csak a csomagban található PLAYMOBIL lövedékeket szabad használni. Óvd a szemeidet és az arcod!

**CZ VAROVÁNÍ!**

- Používat pouze v mělké vodě a pod dohledem!
- Používejte pouze střely PLAYMOBIL, které jsou součástí dodávky. Nemiřte na oči nebo na obličej!

**EST HOIATUS!**

- Kasutamiseks ainult vees, kus lapse jalad ulatuvad põhja ja täiskasvanu järelevalve all.
- Kasutage ainult kaasaantud PLAYMOBIL'i laskemoona. Ära sihi silmadesse ega näkku.

**LV BRĪDINĀJUMS!**

- Lietojams tikai sekļā ūdenī un uzraudzībā.
- Izmantot tikai PLAYMOBIL piegādes komplektā iekļautos šāviņus. Nevērst pret acīm vai seju.

**LT DĖMESIO!**

- Naudoti prižiūrint suaugusiesiems ir tokiam gylyje, kur vaikas gali stovėti.
- Naudokite tik pridedamus PLAYMOBIL šaudmenis. Netaikyti į akis arba veidą.

**SLO OPOZORILO!**

- Uporabljeni samo v plitvi vodi in pod nadzorom.
- Uporablajte le priložene PLAYMOBIL-ove krogle. Ne merite v oči ali obraz.

**SK UPOZORNENIE!**

- Používať len vo vode primerane hlbokej dieťaťu a pod dohľadom.
- Používajte len náboje dodávané spolu so sadou PLAYMOBIL. Nemierť do očí alebo do tváre.

**PL UWAGA!**

- Tylko do użytku w wodzie płytkiej i pod nadzorem.
- Stosować tylko załączone PLAYMOBIL - kule / pociski. Nie celować w oczy i twarz.

**TR CY DİKKAT!**

- Sadece denetim altında ve sadece alçak sularda kullanın.
- Sadece birlikte verilen PLAYMOBIL mermileri kullanınız. Göze veya yüze doğru tutmayınız.

**GR CY ΠΡΟΣΟΧΗ!**

- Να χρησιμοποιείται μόνο σε νερά όπου πατώνει το παιδί και κάτω από επίβλεψη.
- Να χρησιμοποιούνται αποκλειστικά τα βλήματα της PLAYMOBIL που περιέχονται στη συσκευασία. Μη σκοπεύετε τα μάτια ή το πρόσωπο.

**RO AVERTIZARE!**

- Se folosește doar sub supraveghere și doar în apă mică.
- Se folosesc doar proiectilele incluse PLAYMOBIL. Nu se țintește în ochi sau în față.

**BG ПРЕДУПРЕЖДЕНИЕ!**

- Да се използва само под наблюдение и в плитки води.
- Използвайте само приложени PLAYMOBIL снаряди. Не насочвайте към очите и лицето.

**CN 警告!**

- 可供孩子在水中使用，但必须在有人监护的情况下。
- 仅能用PLAYMOBIL的炮弹。禁止瞄准眼睛或脸。请勿瞄准眼睛或脸。

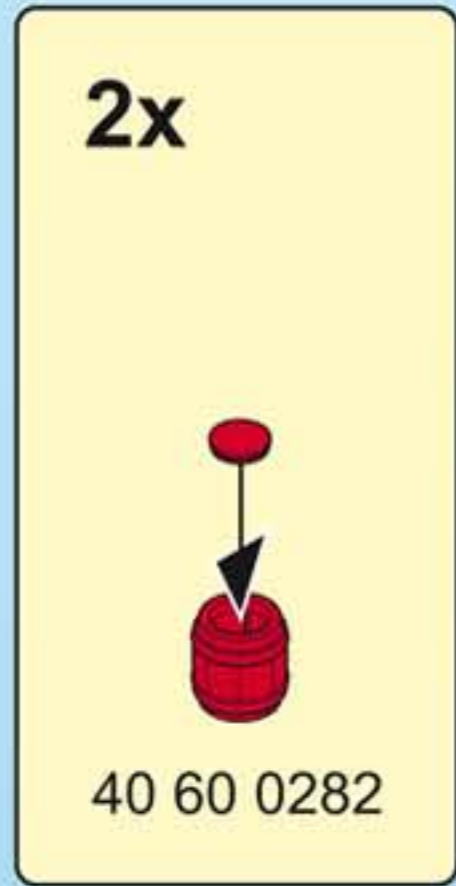

40 66 0120

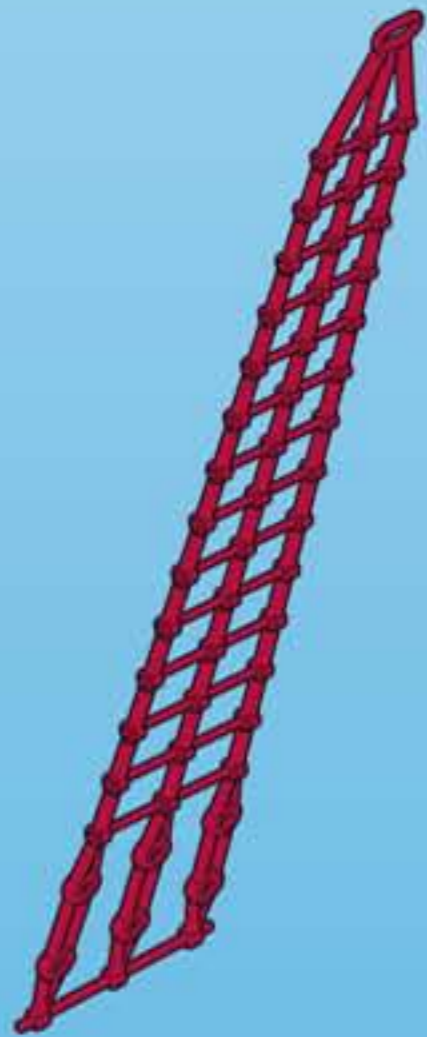

2x 40 20 0130

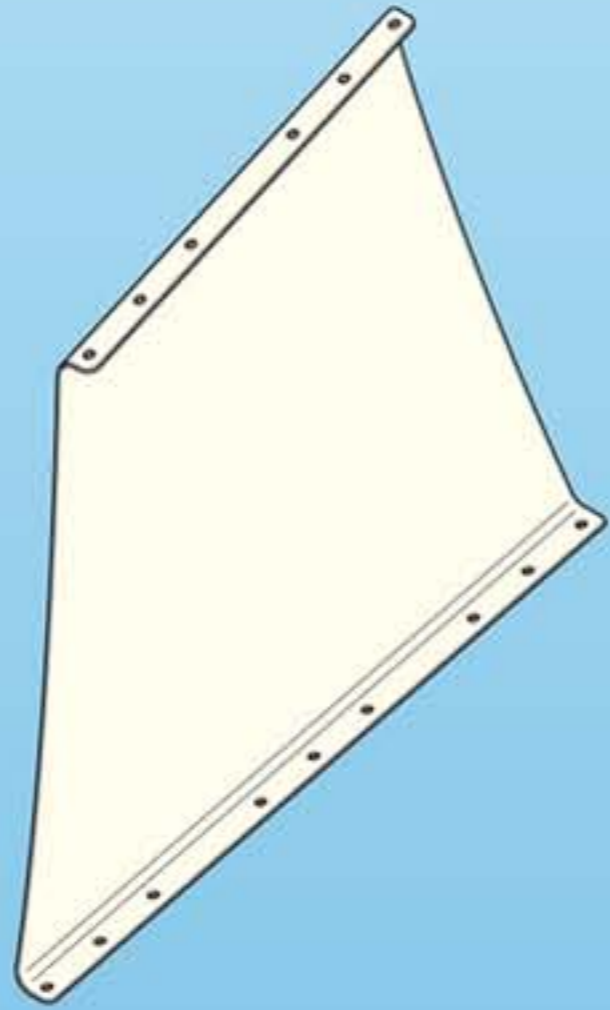

40 80 0020

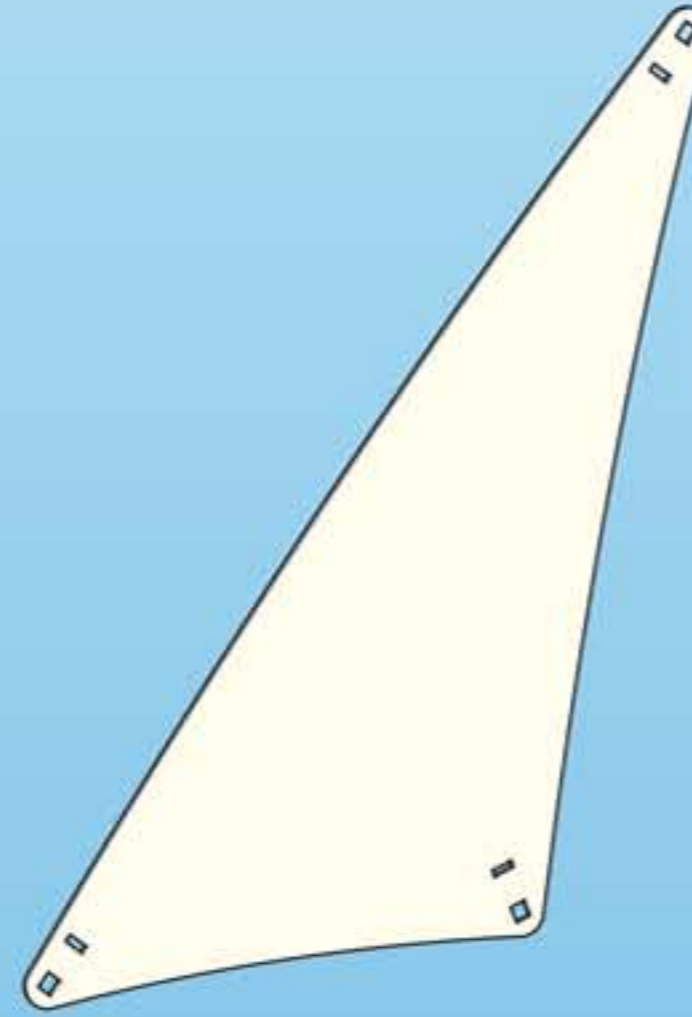

40 80 0030

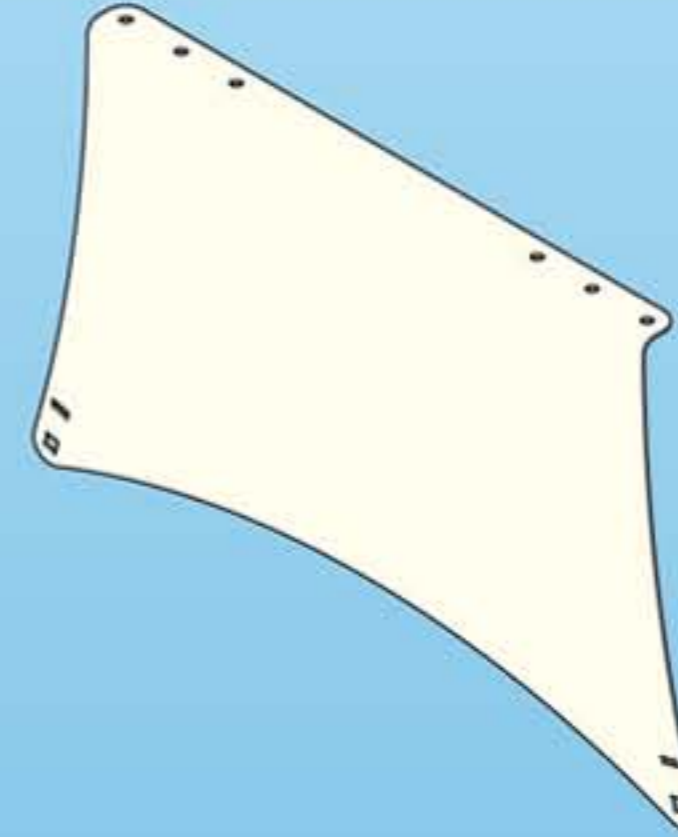

40 80 0010



40 80 0000



40 45 0050



40 45 0040



40 45 0070



40 45 0060

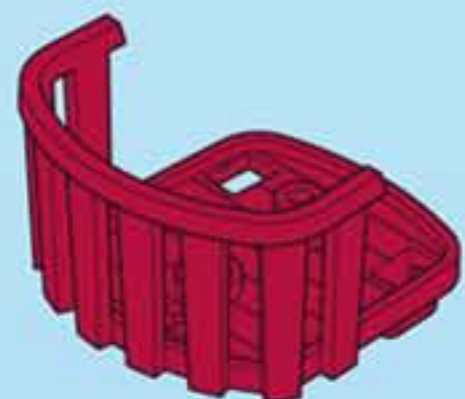

40 45 0010

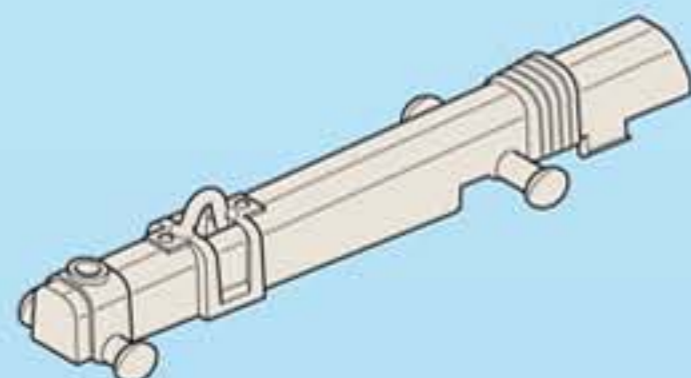

40 20 0090



40 45 0020

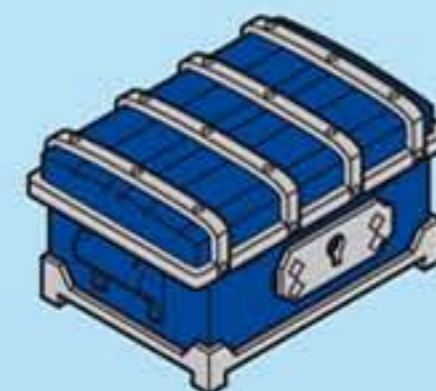

40 66 0080



40 45 0080



40 22 6680



40 20 0150



40 66 0100



40 09 5230



2x 30 66 9982



2x 40 45 0110



40 27 1640



2x 30 27 4240



40 45 0100



4x 40 45 0090



40 09 5650



40 20 0060



40 06 0710



2x 40 09 5440



11x 40 20 0140



40 61 3730



40 07 9190



40 22 8890

Serviceadressen finden Sie in allen Playmobil-Prospekten

Addresses of Customer Service Departments are shown in all Playmobil catalogues

L'adresse du service consommateurs est indiquée dans tous les catalogues Playmobil

Troverete gli indirizzi dei centri di assistenza in tutti i cataloghi Playmobil

In alle PLAYMOBIL catalogi vindt u het adres van onze klantendienst.

Las Direcciones de los Departamentos de Servicio al Consumidor se encuentran en todos los catálogos Playmobil

Η διεύθυνση του Γραφείου Εξυπηρέτησης Πελατών είναι καταχωρημένη σε όλους τους καταλόγους Playmobil

pronounce: plāy-mō-bēēl