

# playmobil®

5881  
5009

**WARNING:**  
CHOKING HAZARD - SMALL PARTS  
Not for children under 3 years.

"Ne concerne que les USA"

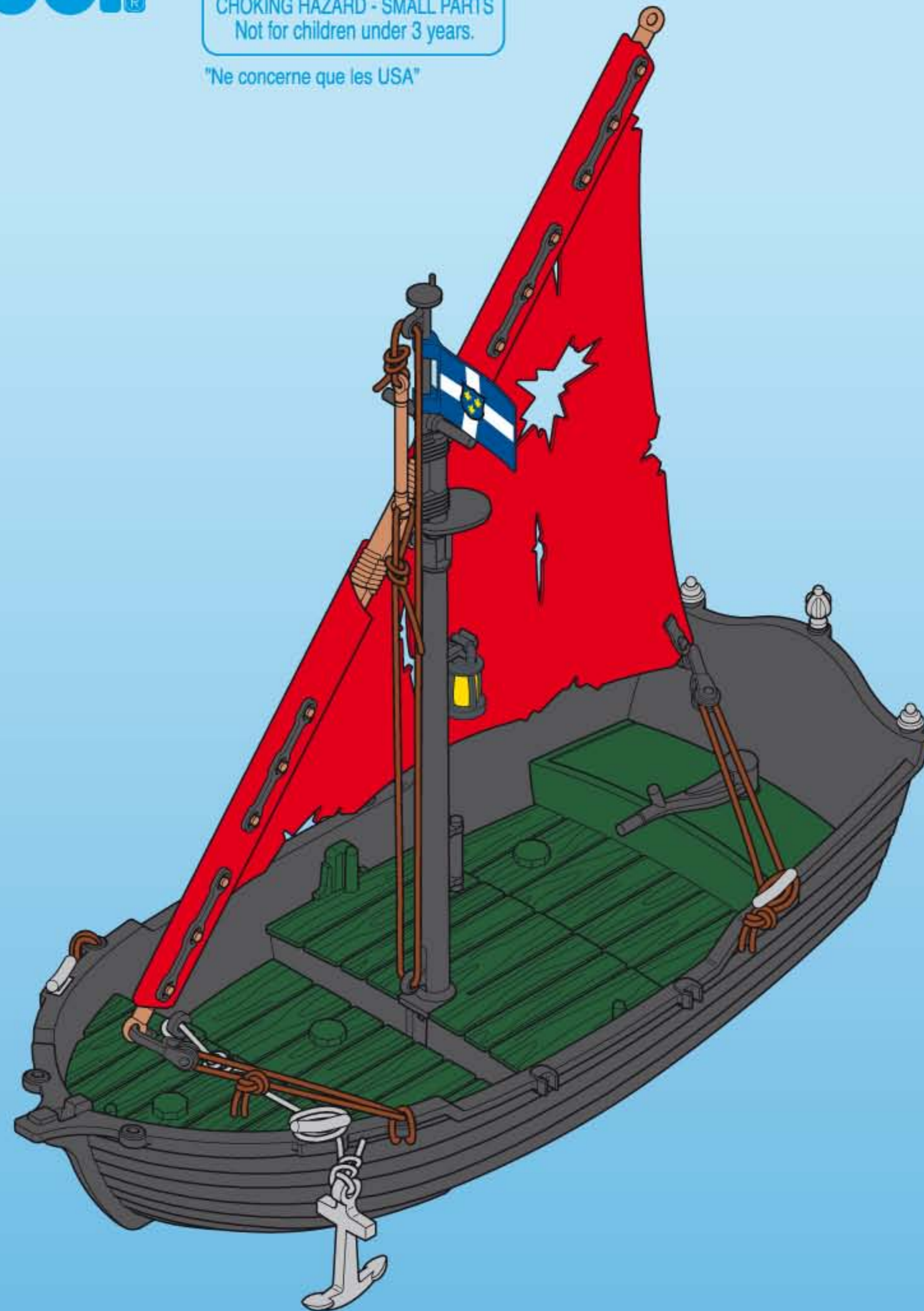

Wichtige Unterlagen, bitte sorgfältig aufbewahren!  
Important documents keep carefully!  
Documents importants conservez avec soin!  
Belangrijke documenten, bewaar deze zorgvuldig!

7350

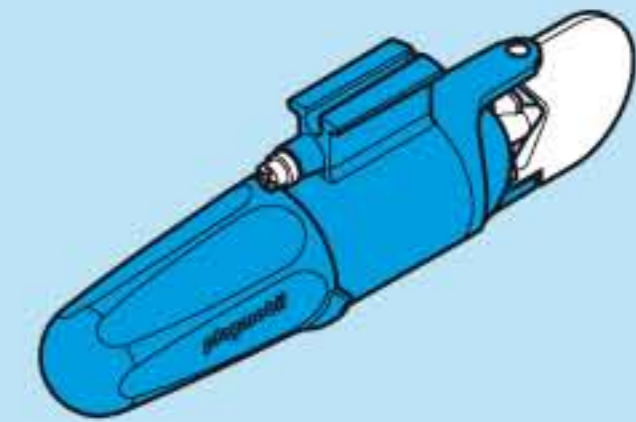

- Nachrüstbar mit Unterwassermotor
- Refittable with underwatermotor
- Moteur submersible, vendu séparément, s'adapte sur ce bateau

1

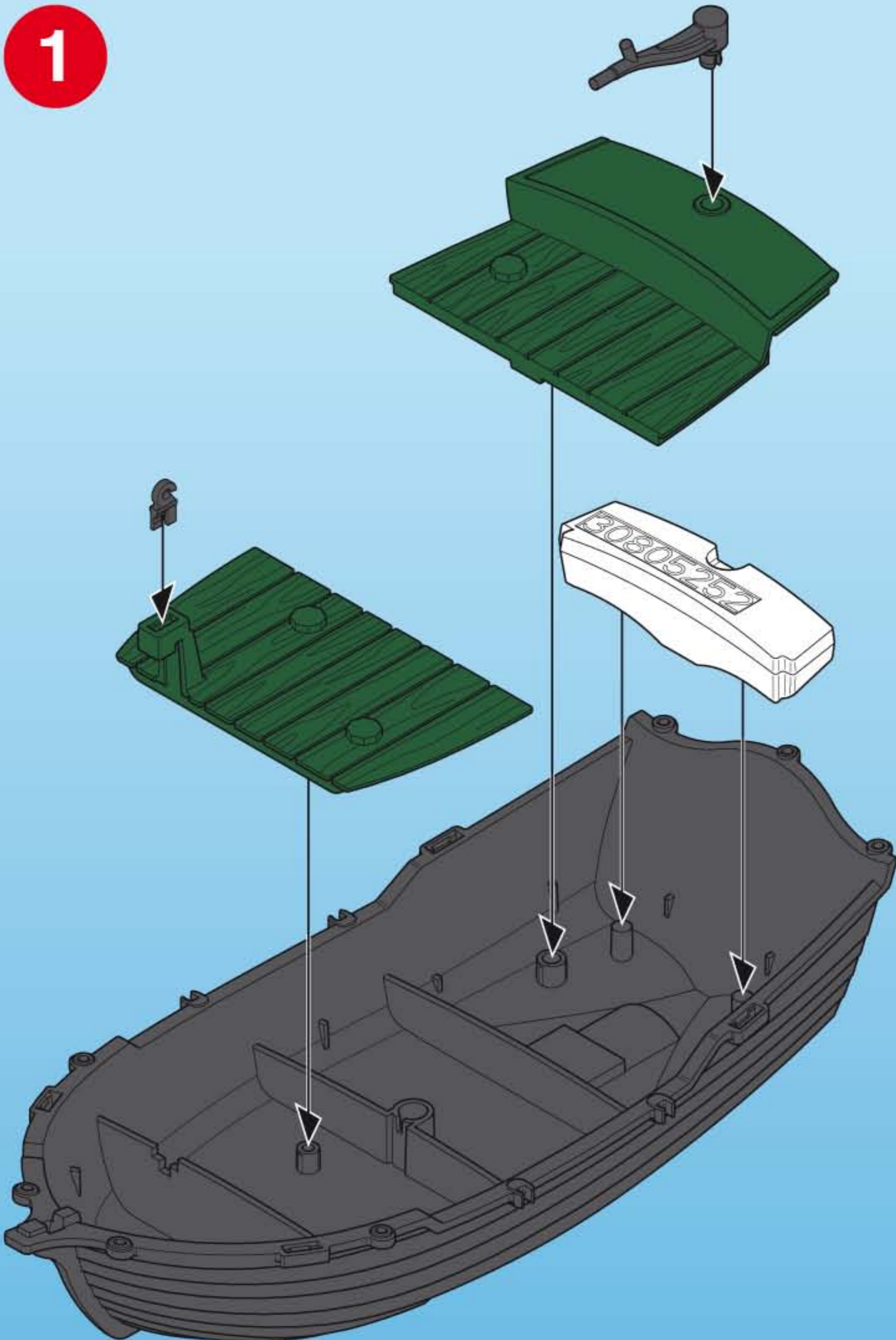

2

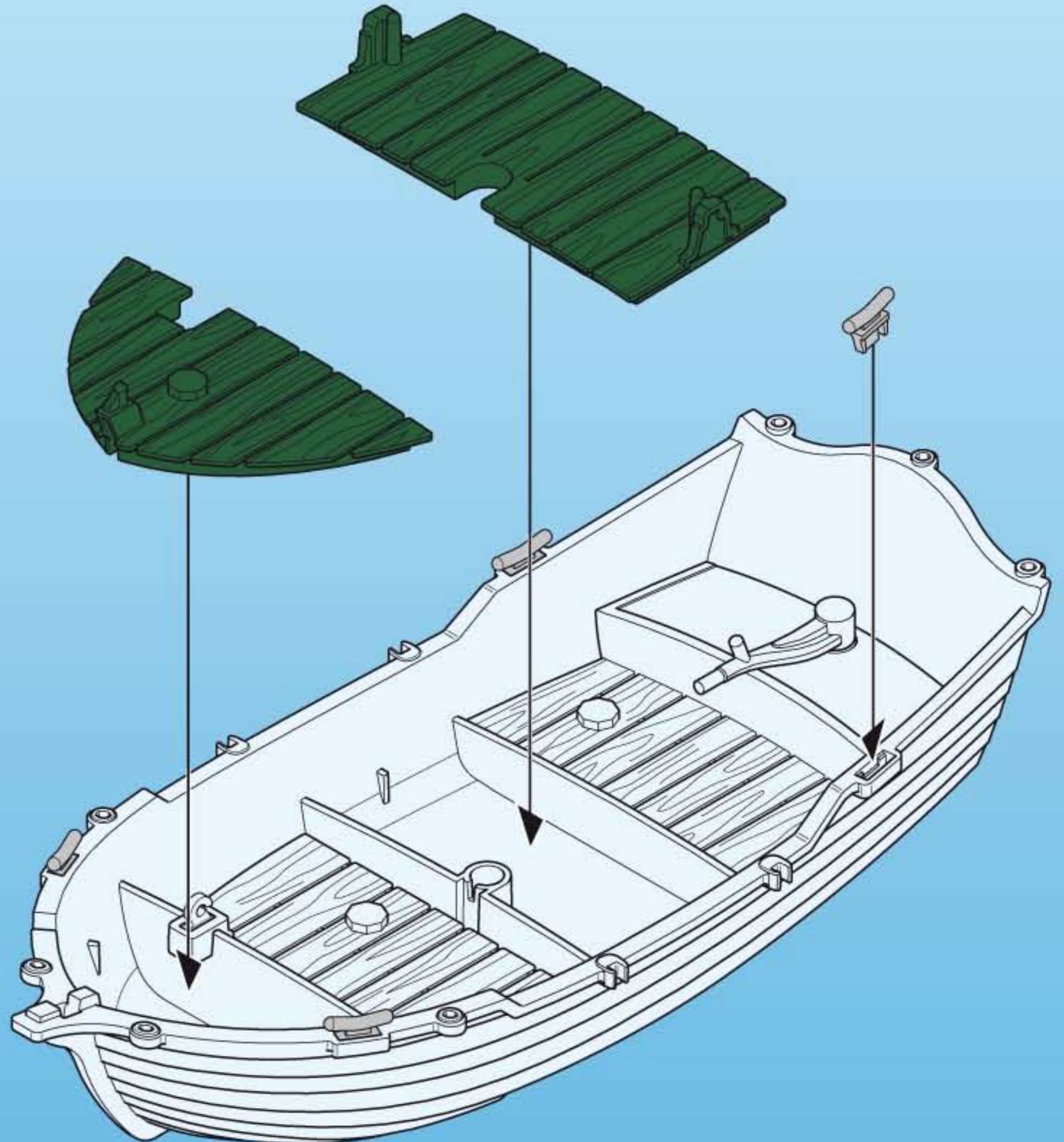

**3**

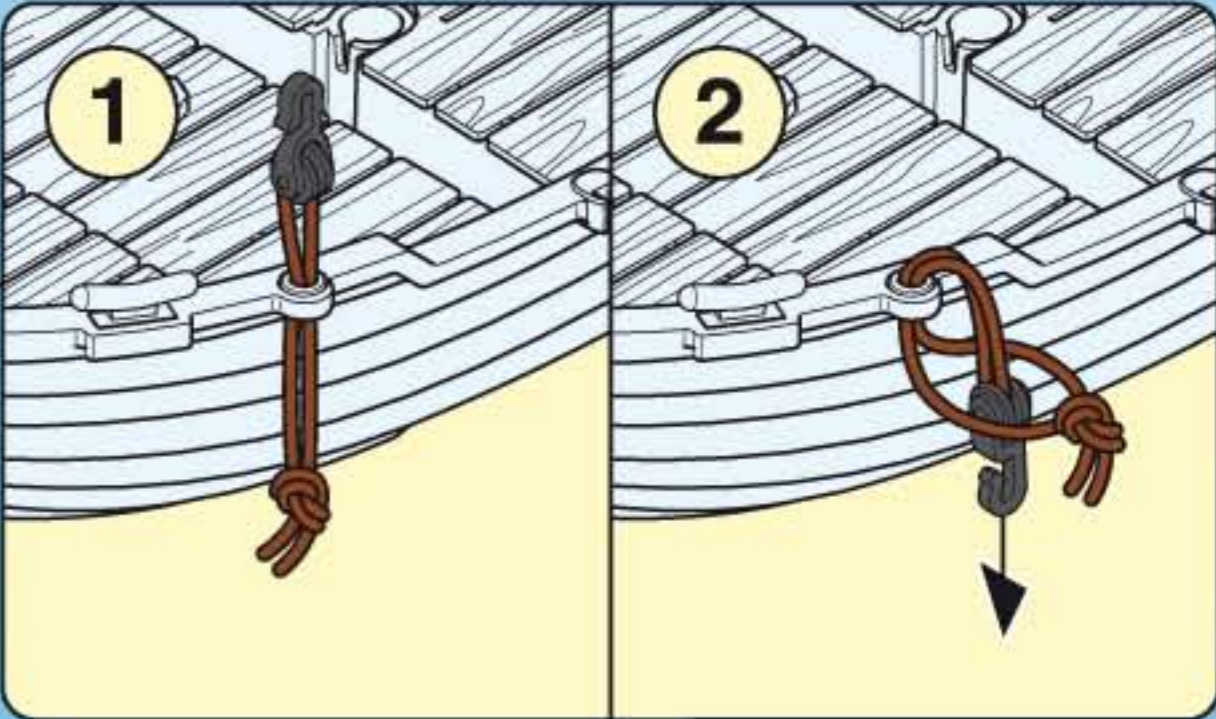
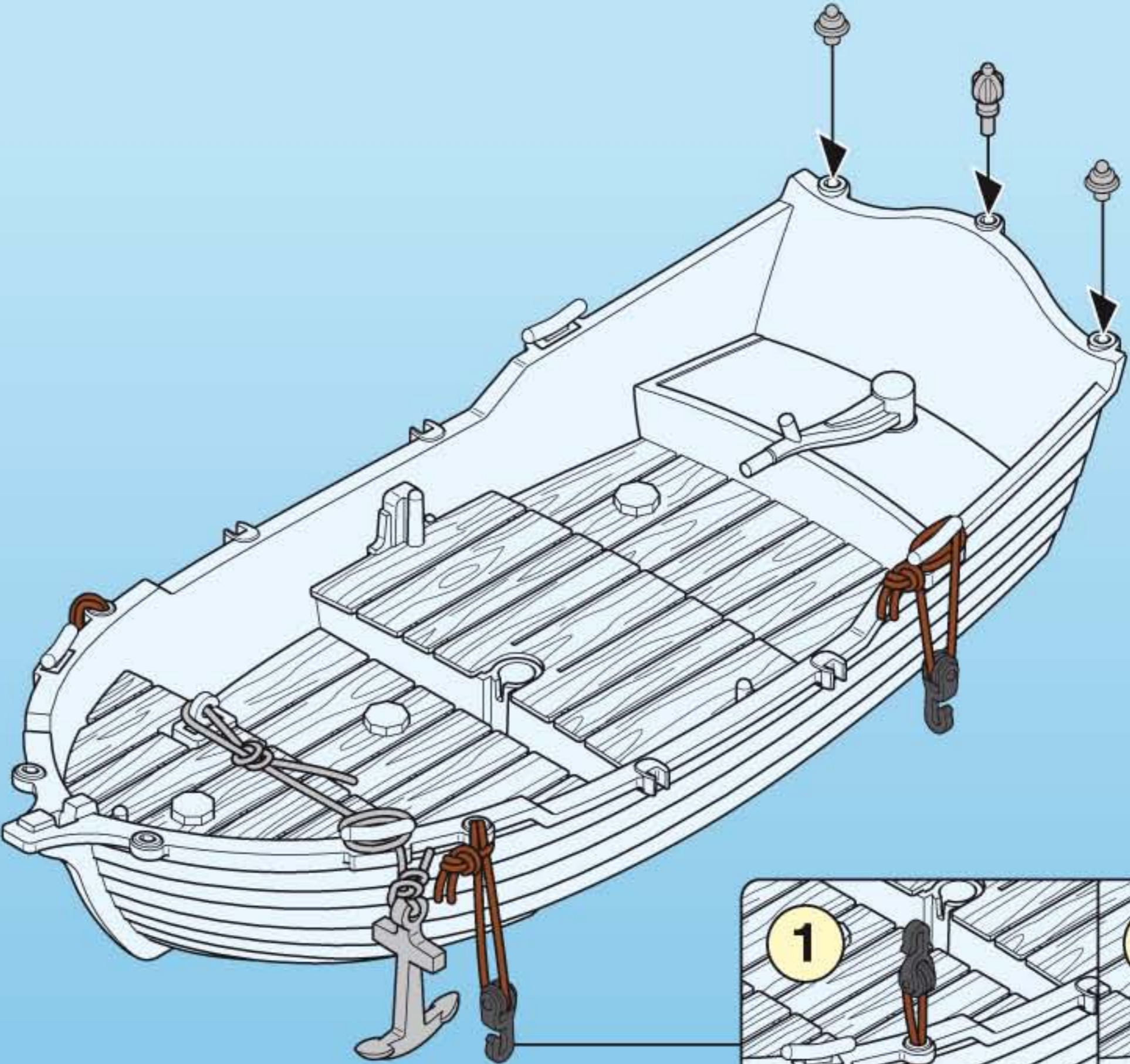
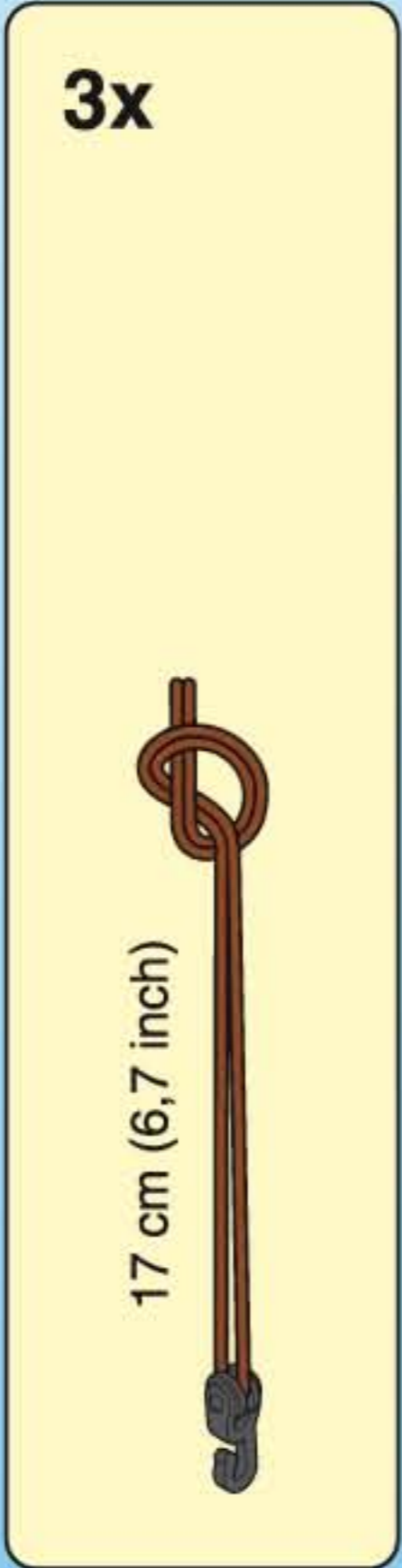
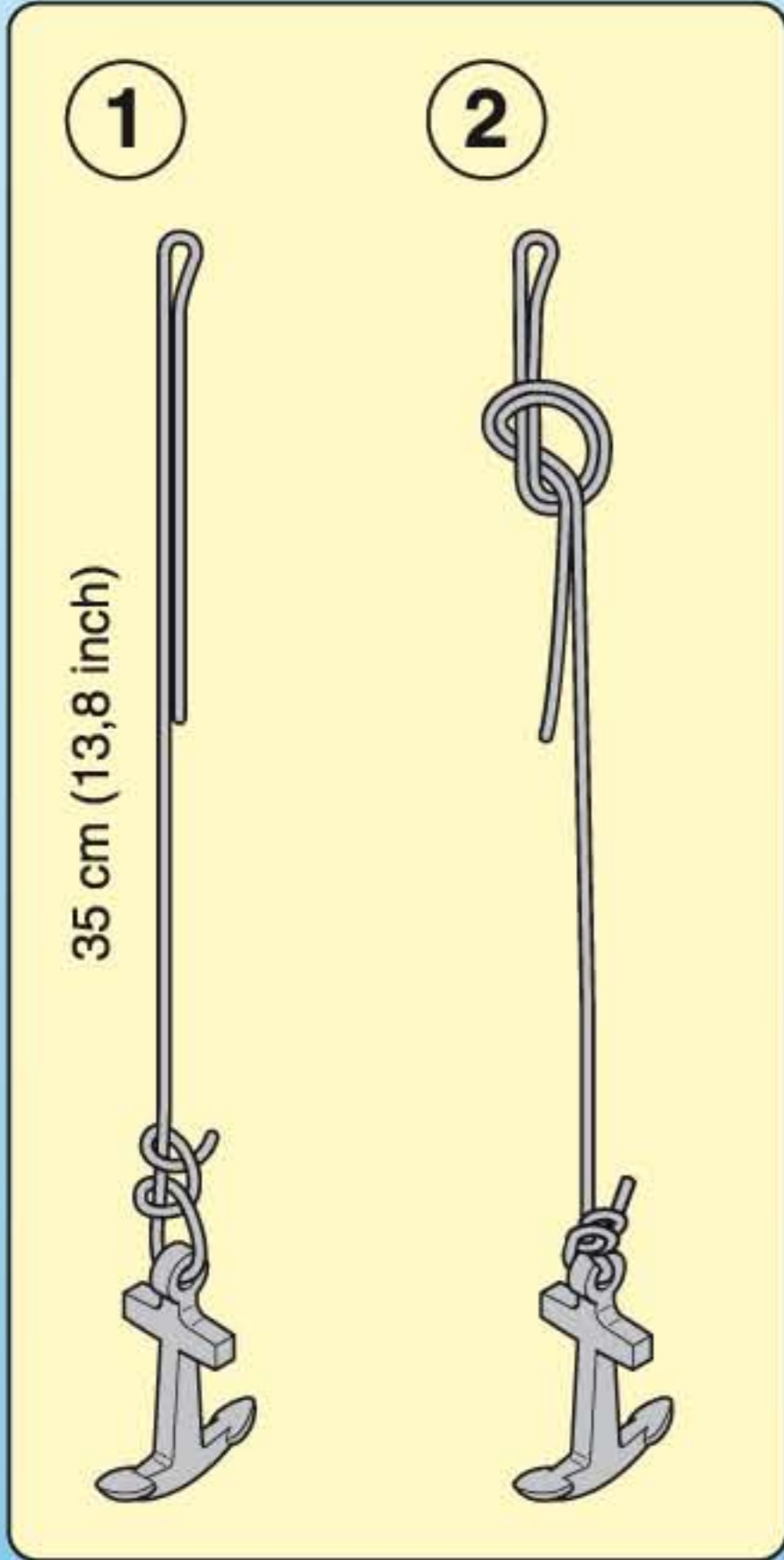

4

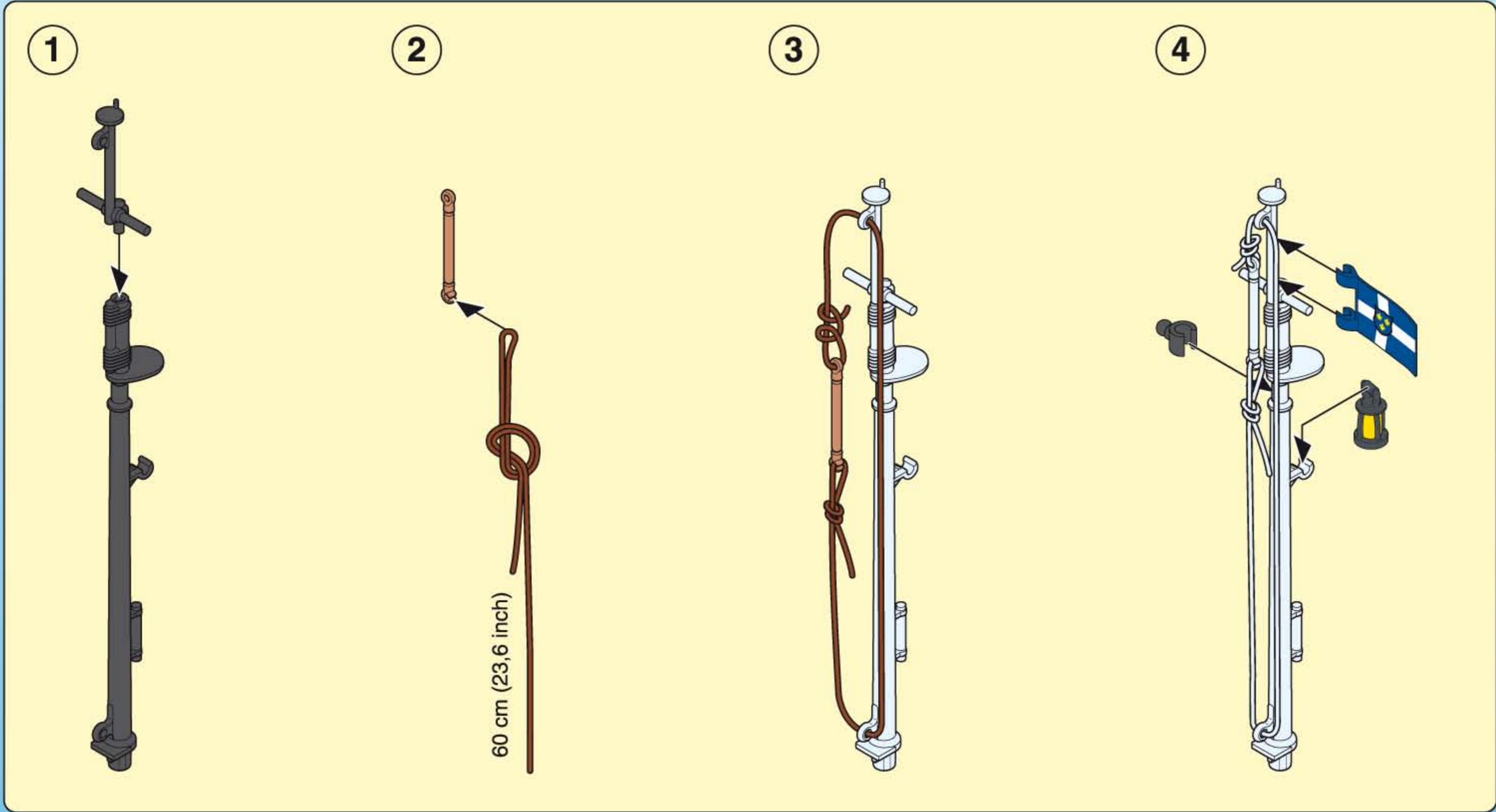

5

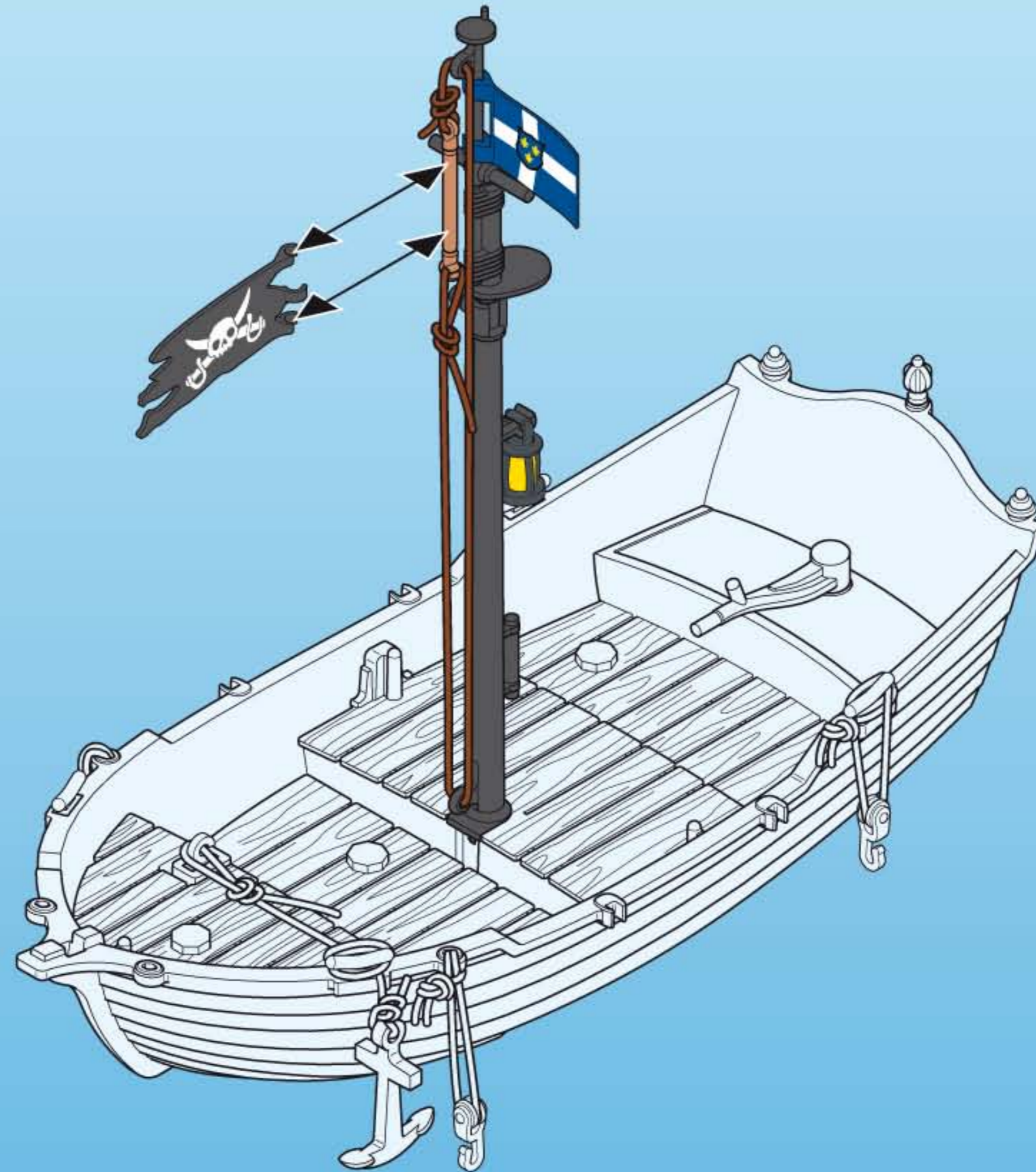

6

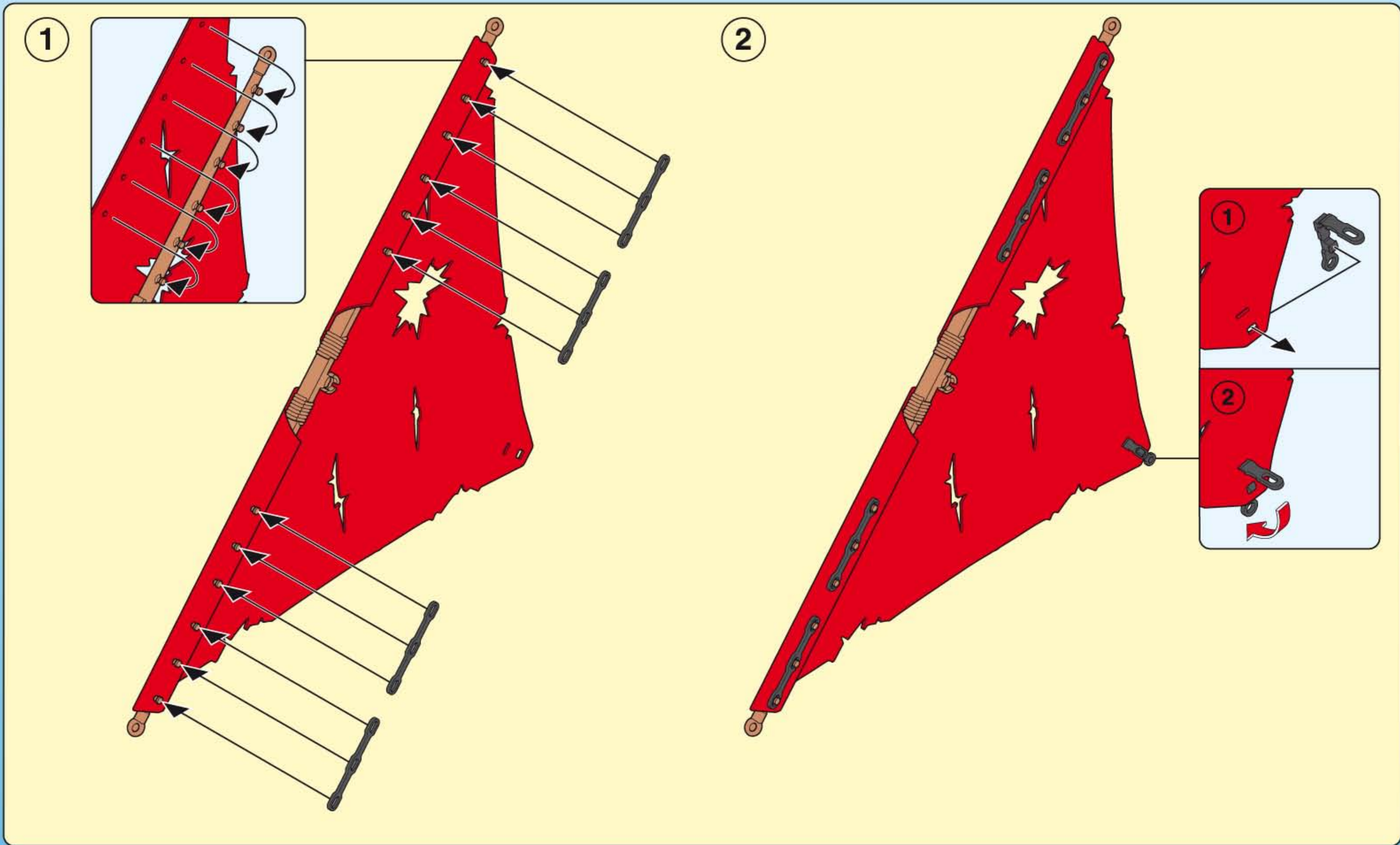

7

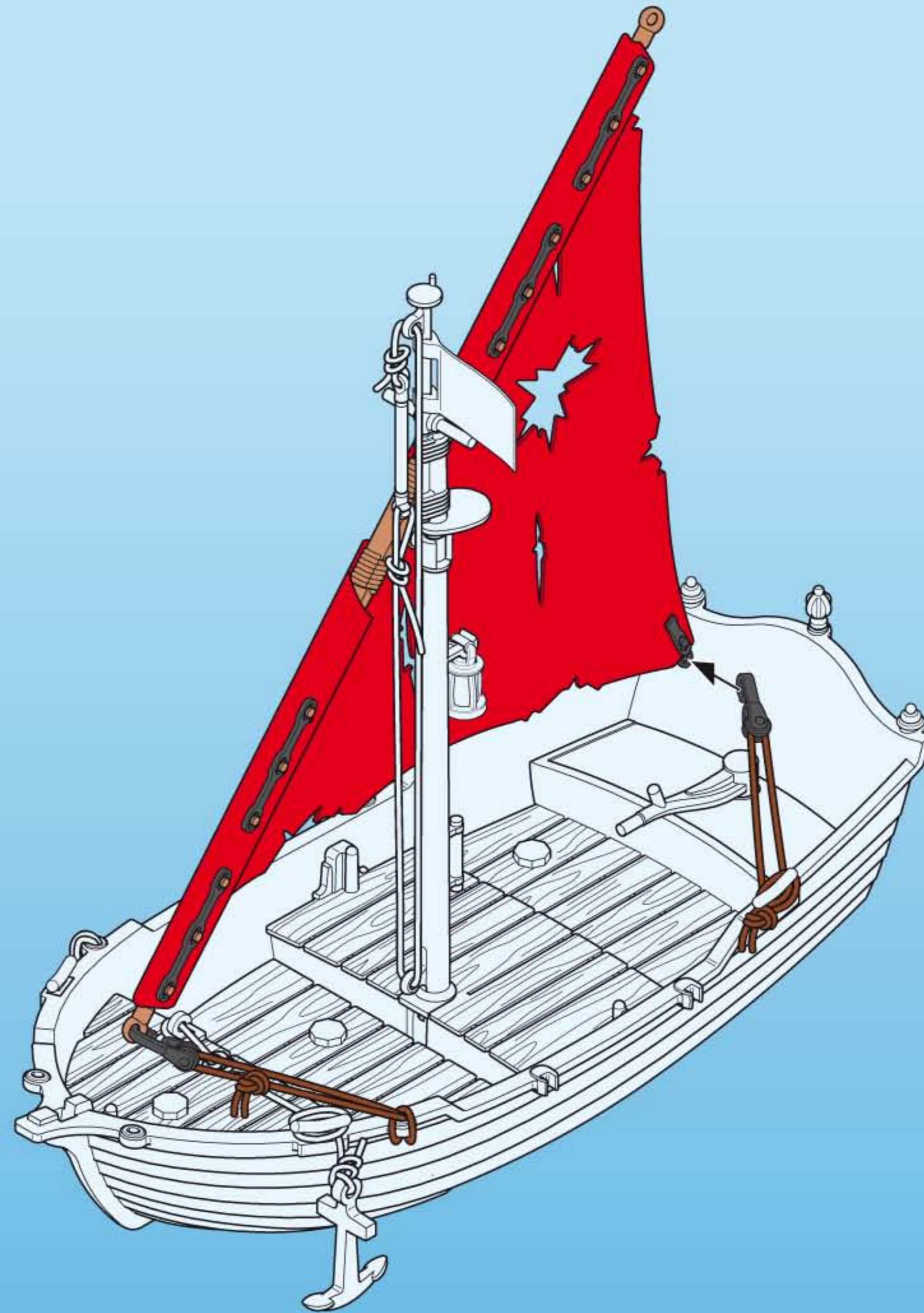

1

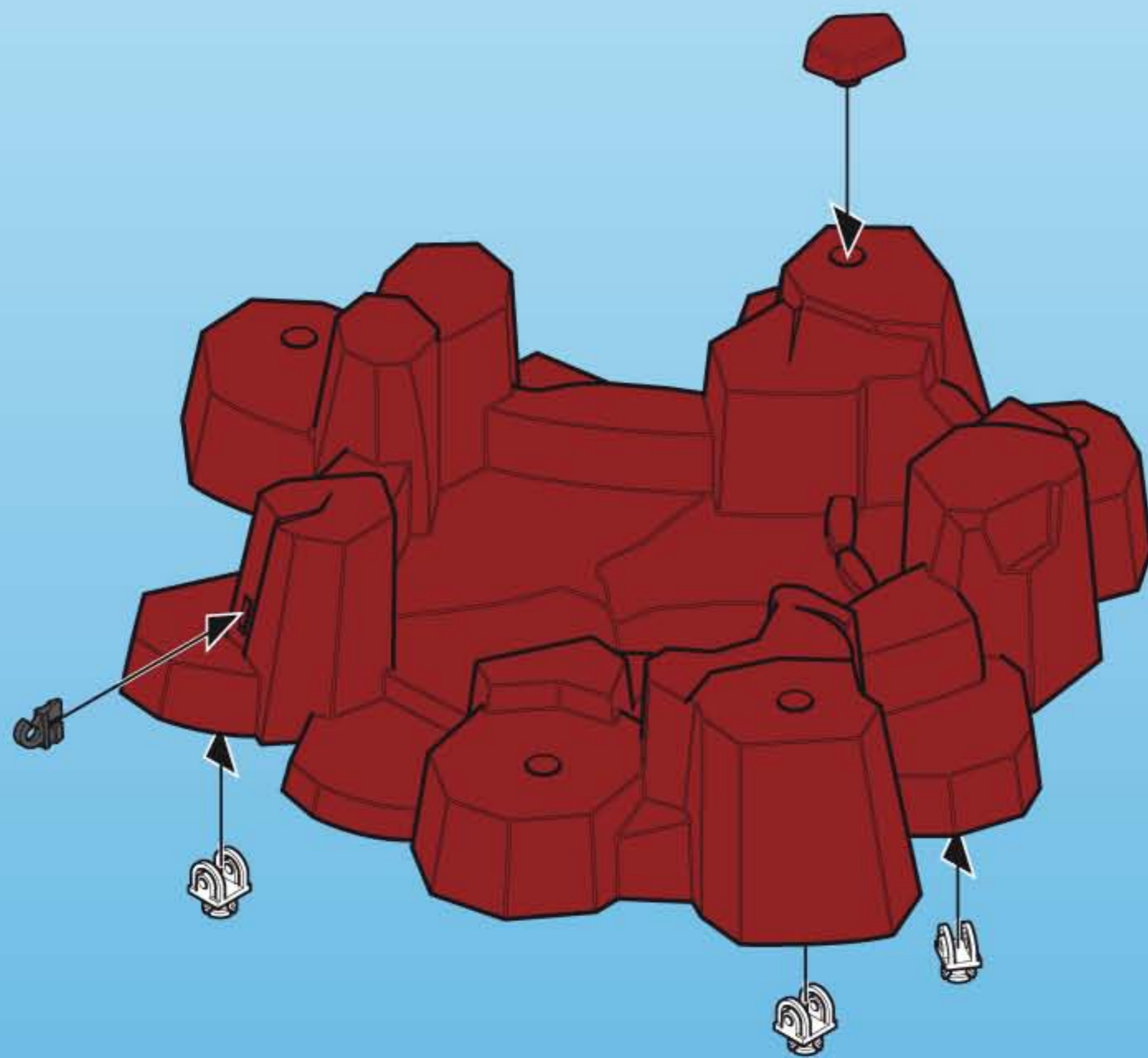
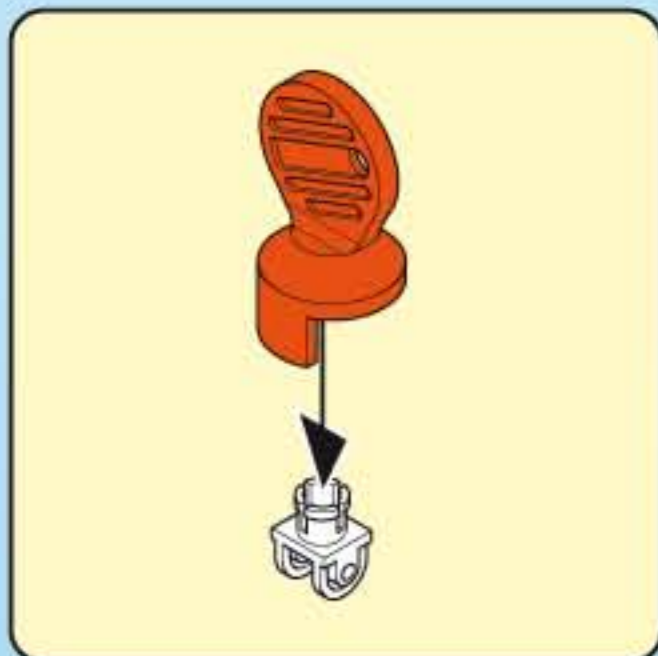



2

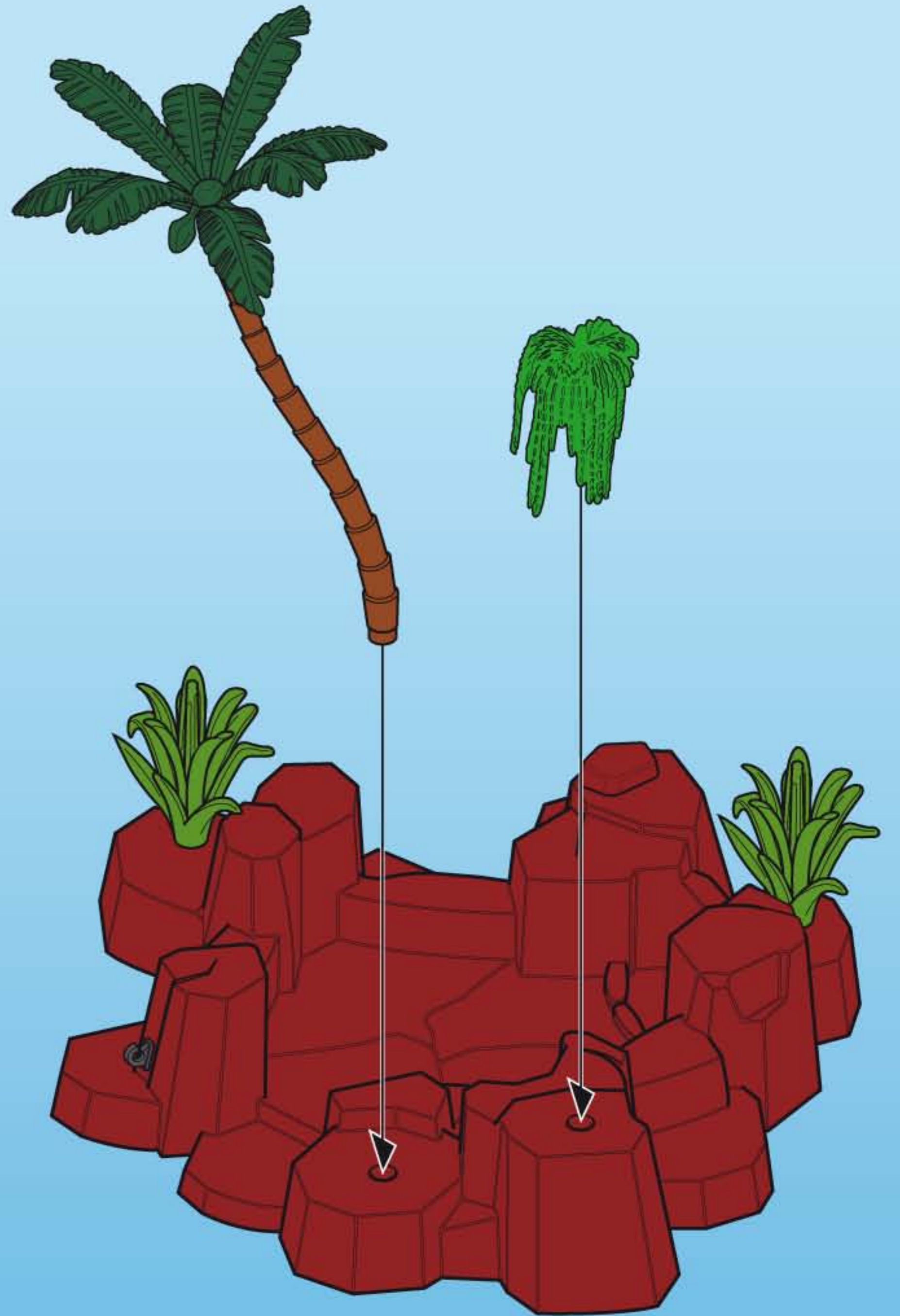
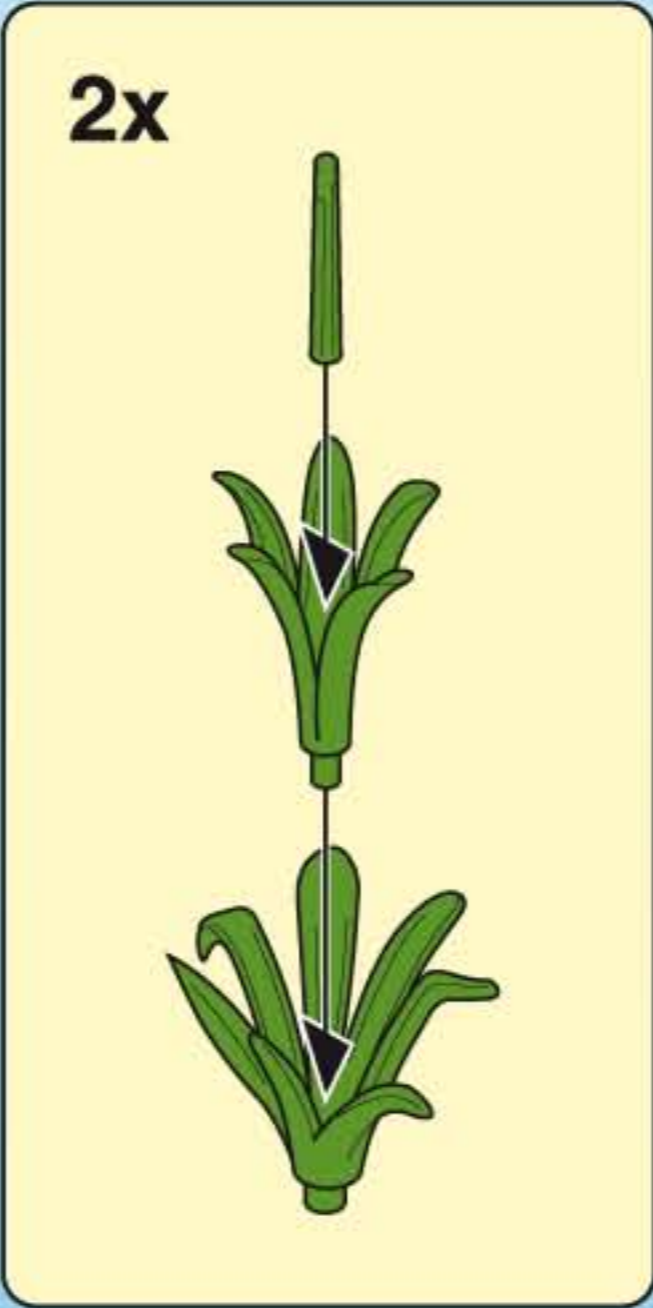
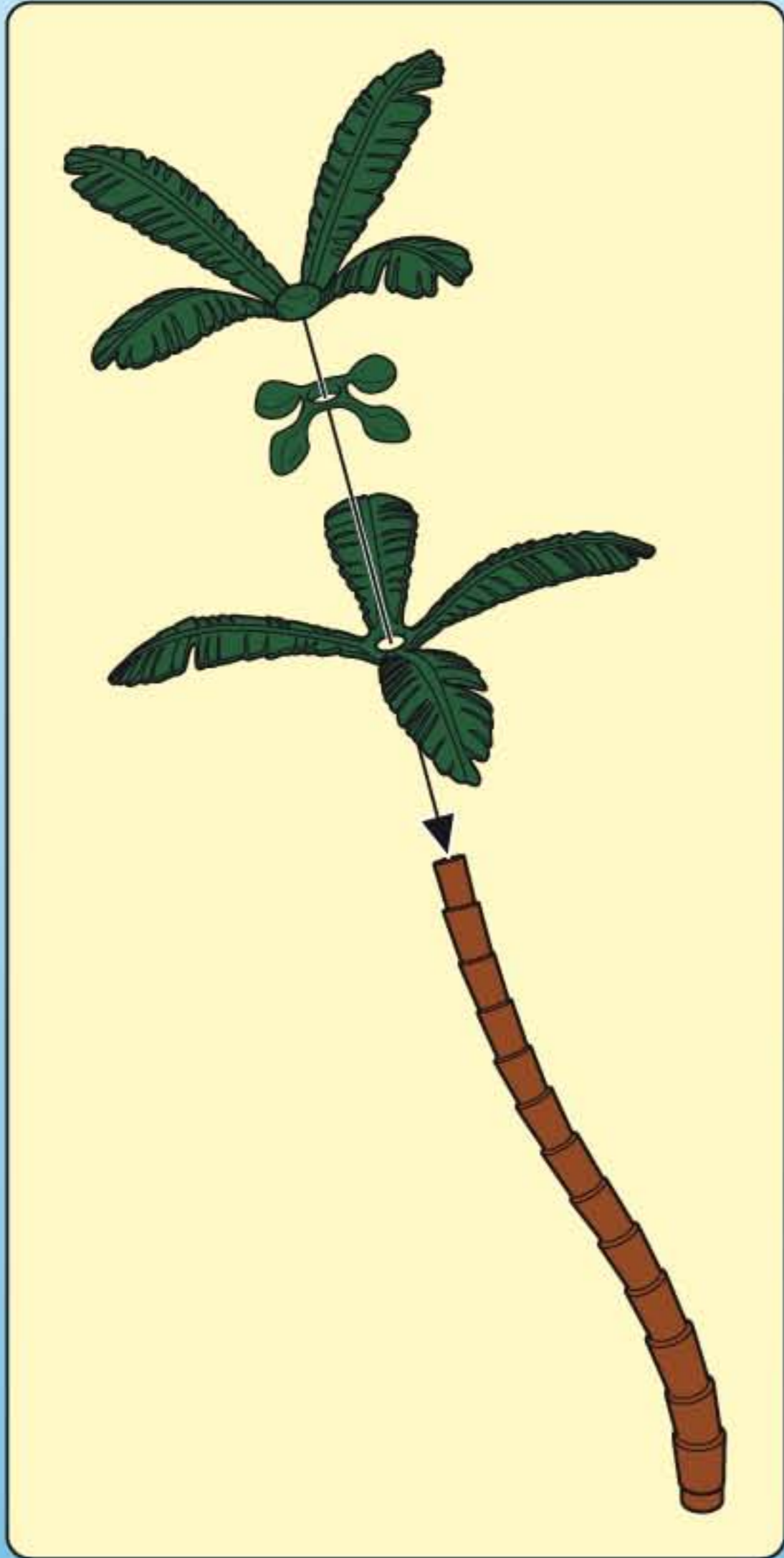

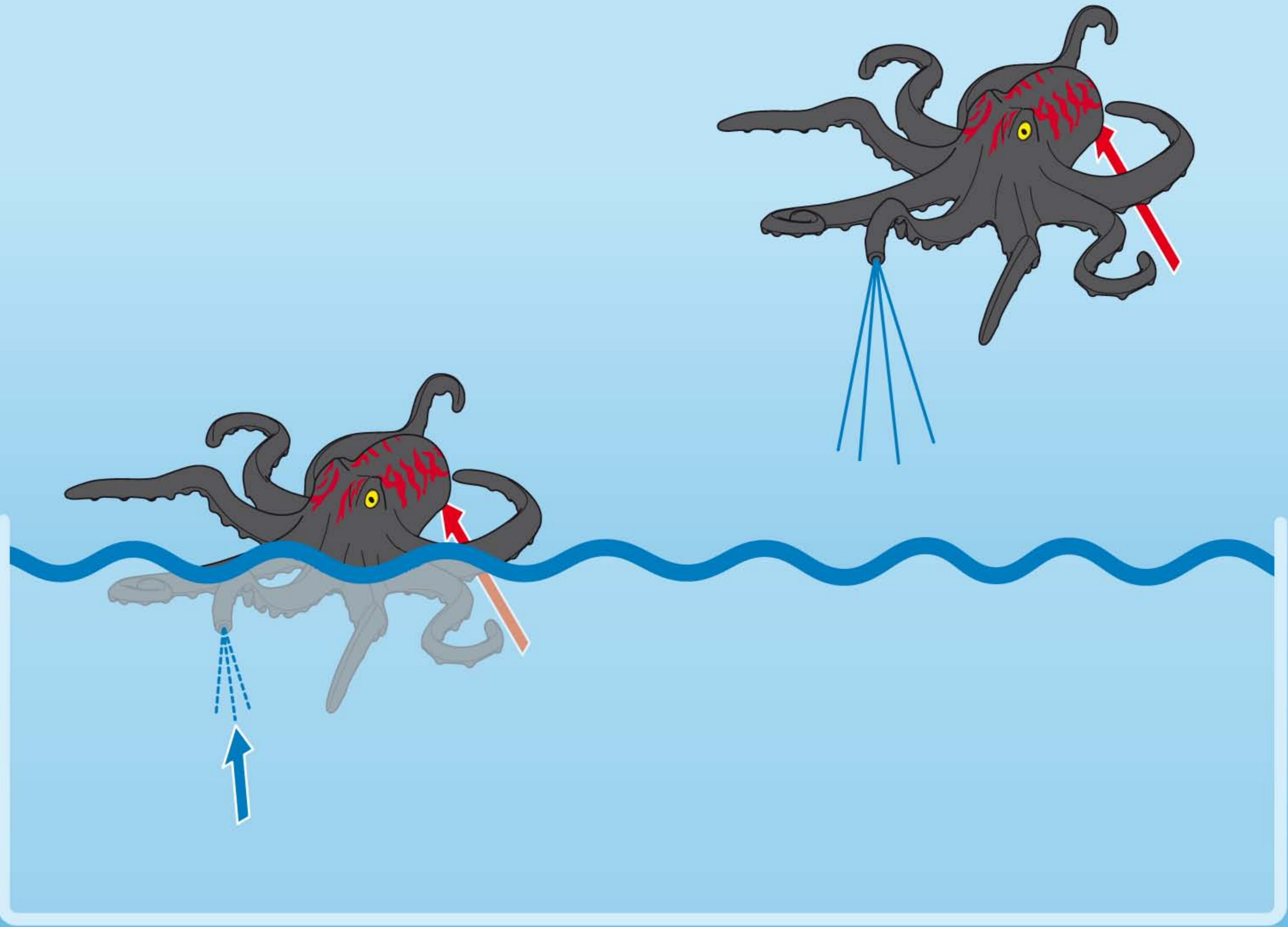

1

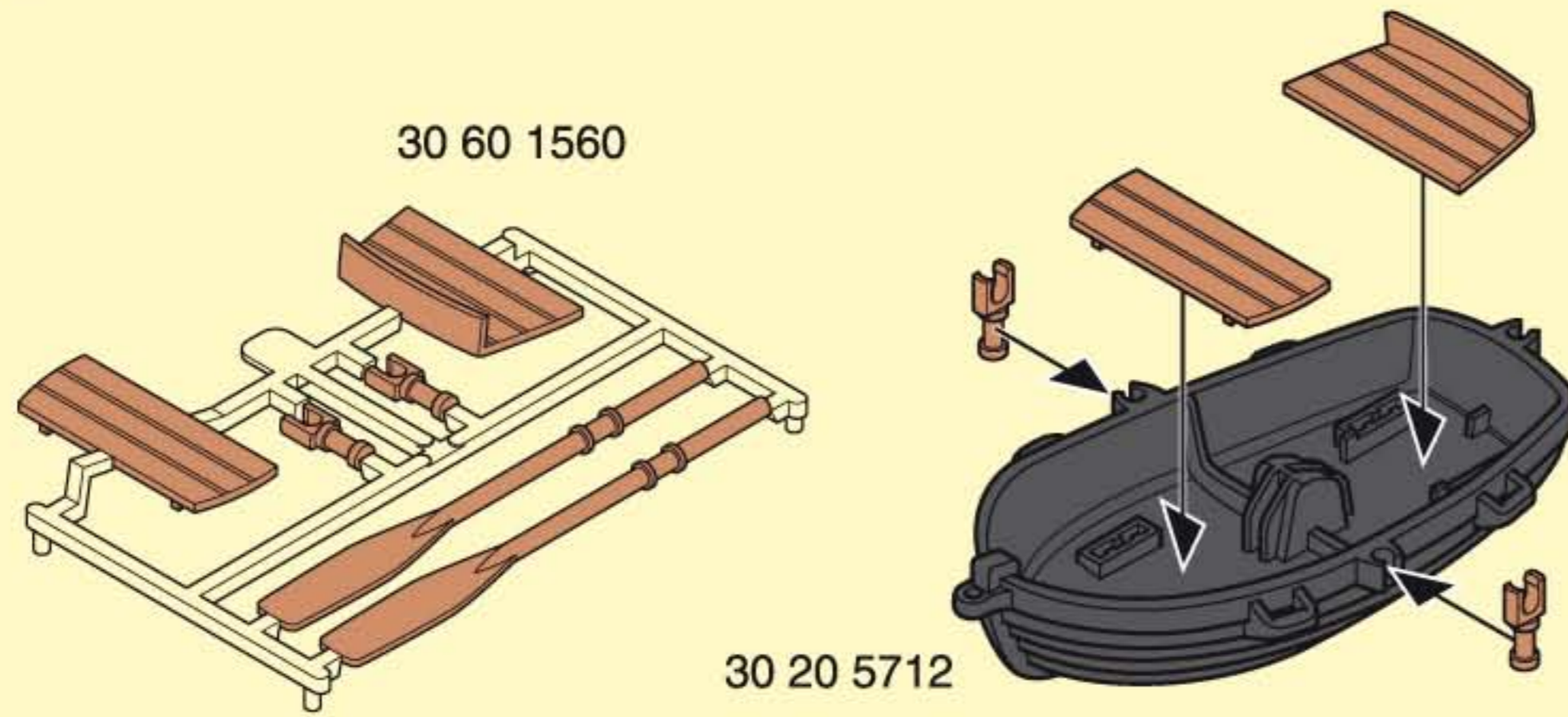

2

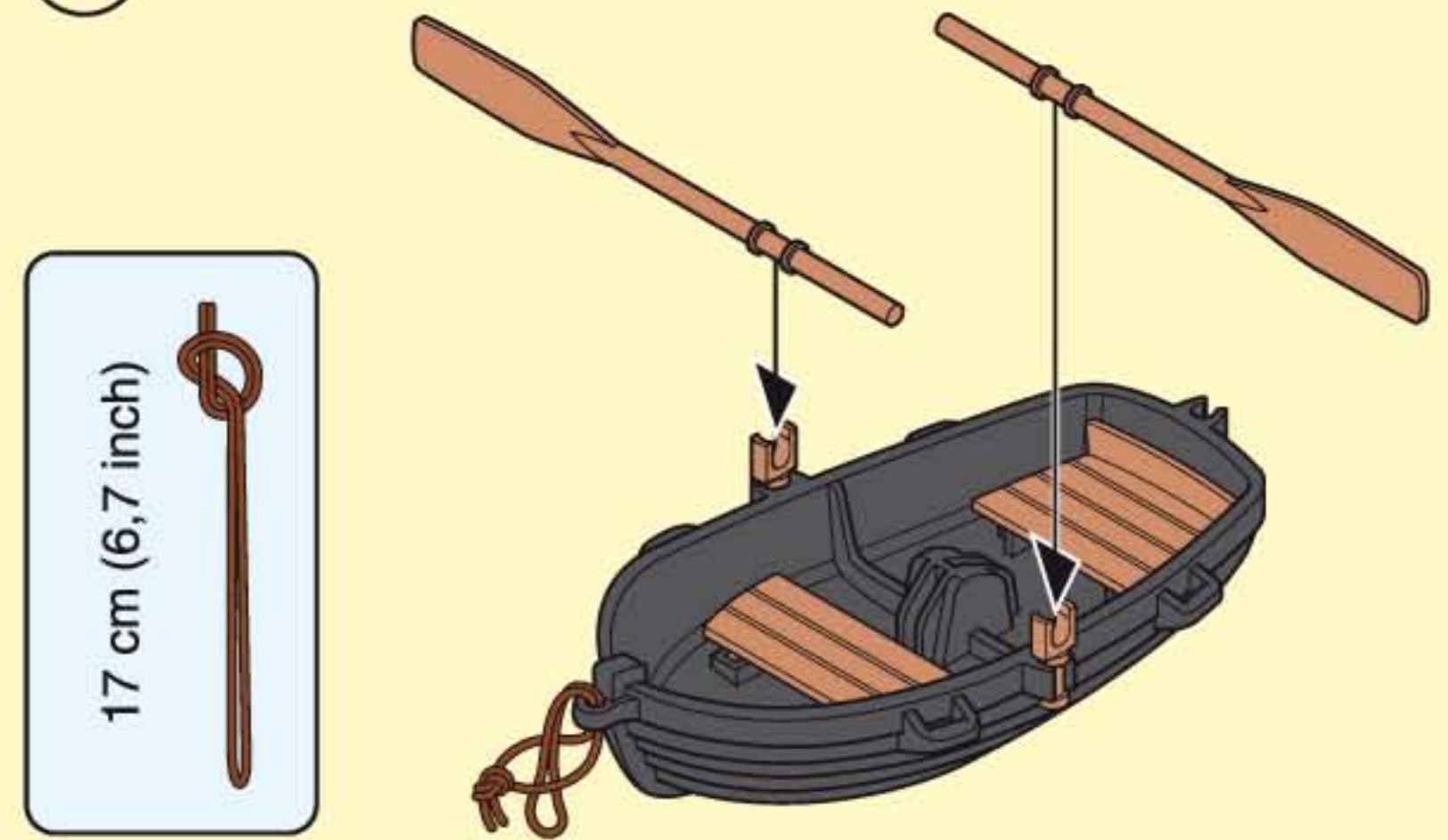

1

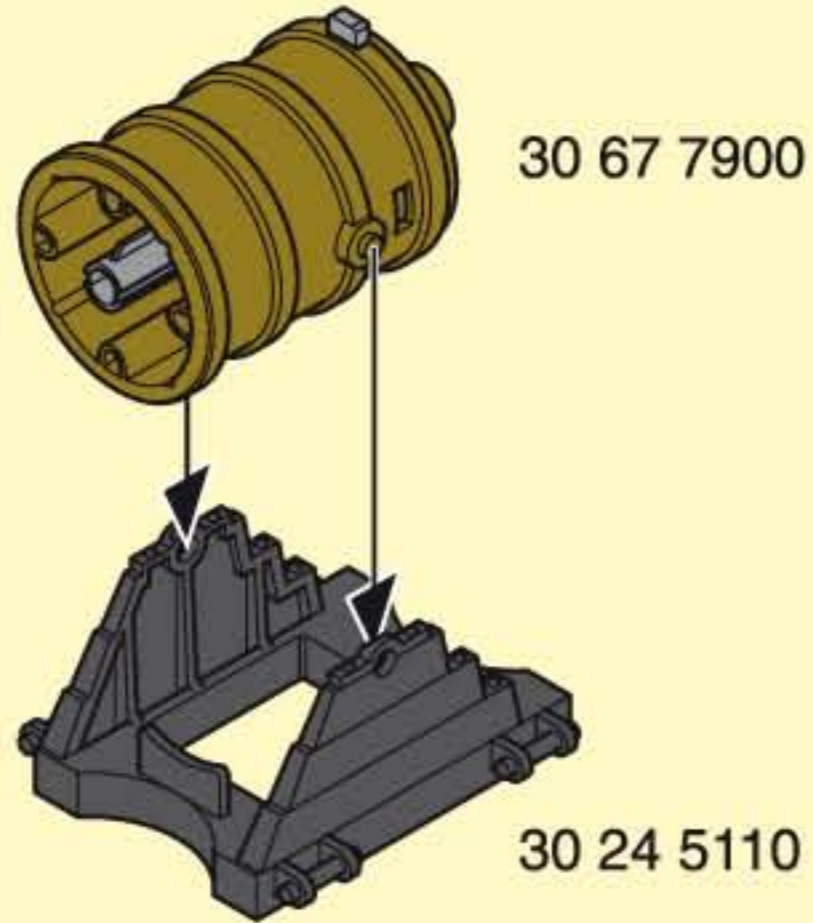

2

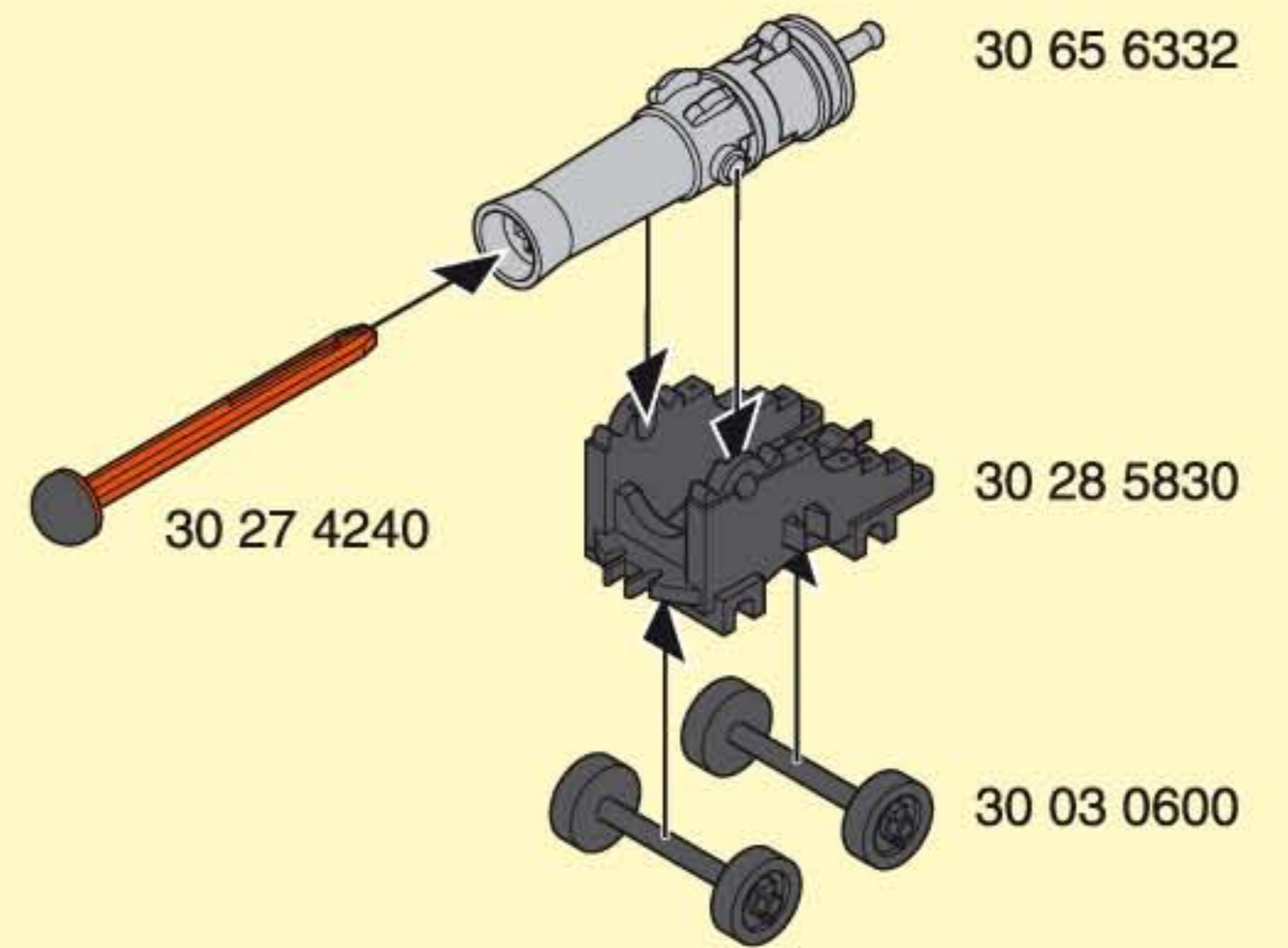
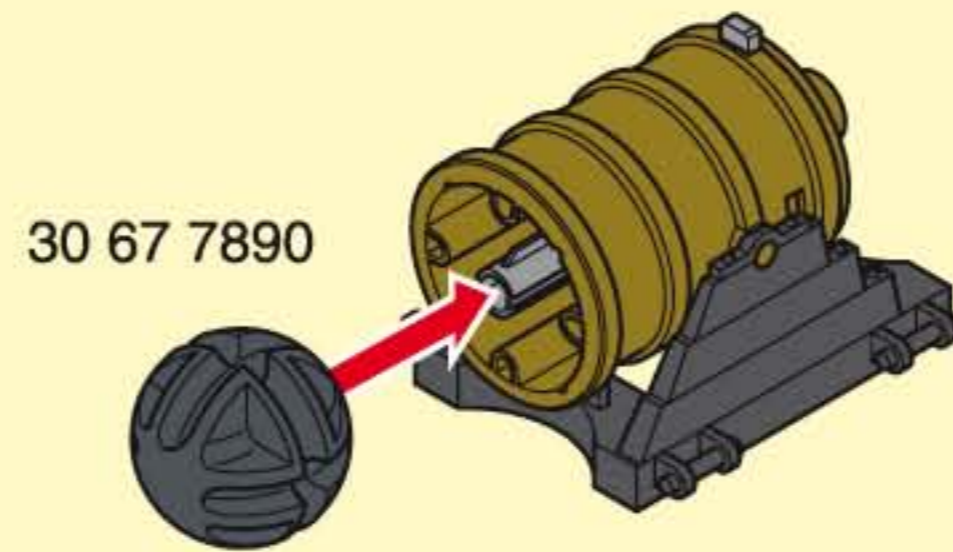

cm  
inch

0

1

2

3

4

5

6

7

8

9

10

11

12

13

14

15

0

1

2

3

4

5

6

**D A CH L B** **WARNUNG!**

- Nur unter Aufsicht und nur in flachem Wasser benutzen.
- Nicht auf Augen oder Gesicht zielen. Nur Trinkwasser verwenden. Nach dem Spielen austrocknen lassen.
- Nur mitgelieferte PLAYMOBIL Geschosse verwenden. Nicht auf Augen oder Gesicht zielen.

**USA GB CDN M IRL** **WARNING!**

- Only to be used in water in which the child is within depth and under supervision
- Do not aim at eyes or face. Use only tap water. Dry thoroughly after play.
- Only use the PLAYMOBIL projectiles supplied. Do not aim at eyes or face.

**F CDN B L CH** **ATTENTION!**

- À n'utiliser qu'en eau où l'enfant a pied et sous surveillance.
- Ne pas viser les yeux ou le visage. N'utiliser que de l'eau potable. Faire sécher après chaque utilisation.
- Seulement utiliser les projectiles PLAYMOBIL fournis. Ne pas viser les yeux ou le visage.

**E MEX** ; **ADVERTENCIA!**

- Se deberá utilizar solamente en el agua, donde el niño haga pie y bajo vigilancia.
- No se ha de apuntar a los ojos ni a la cara. Utilizar solamente agua potable. Dejar secar antes de guardar.
- Utiliza únicamente los proyectiles PLAYMOBIL suministrados. No se ha de apuntar a los ojos ni a la cara.

**NL B** **WAARSCHUWING!**

- Alleen gebruiken onder toezicht, in water waarin het kind kan staan.
- Niet op ogen of gezicht richten. Enkel drinkbaar water gebruiken. Na het spelen laten drogen.
- Uitsluitend meegeleverde PLAYMOBIL delen gebruiken. Niet op ogen of gezicht richten.

**I CH** **ATTENZIONE!**

- Utilizzare solo in acque dove il bambino tocca con i piedi e sotto sorveglianza.
- Non mirare agli occhi o al viso. Usare solo acqua potabile. Asciugare bene dopo ogni uso.
- Usare soltanto i proiettili PLAYMOBIL in dotazione. Non mirare agli occhi o al viso.

**P** **AVISO!**

- Utilizar apenas em águas em que a criança tenha pé e sob vigilância.
- Não apontar para os olhos ou face. Utilizar somente água potável. Deixar secar antes de guardar.
- Usar apenas os projecteis PLAYMOBIL juntamente fornecidos. Não apontar para os olhos ou face.

**DK** **ADVARSEL!**

- Må kun anvendes under opsyn og på vanddybder, hvor barnet kan bunde.
- Sigt ikke mod øjne eller ansigt. Anvend kun drikkevand. Lad det tørre ud når du er færdig med at lege.
- Anvend kun de medfølgende PLAYMOBIL projektiler. Sigt ikke mod øjne eller ansigt.

**N** **ADVARSEL!**

- Skal kun brukes i vann som ikke er for dypt for barnet, og der barnet er under tilsyn.
- Sikt ikke på ansikt eller øyne. Kun drikkevann skal benyttes. Tørk opp etter at leken er ferdig.
- Benytt kun PLAYMOBIL prosjektil som leveres med. Sikt ikke på ansikt eller øyne.

**S FIN** **VARNING!**

- Får endast användas på grunt vatten och under uppsikt av vuxen.
- Sikta ej mot ögonen eller ansiktet. Använd endast dricksvatten. Låt torka efter användandet.
- Använd endast medlevererade PLAYMOBIL-skott. Sikta ej mot ögonen eller ansiktet.

**FIN** **VAROITUS!**

- Käytetään ainoastaan matalassa vedessä, jossa lapsi voi seistä ja on aikuisen valvonnassa.
- Älä tähtää päin silmiä tai kasvoja. Käytä ainoastaan juomavettä. Anna kuivua leikin jälkeen.
- Käytä vain mukana toimitettuja PLAYMOBIL-ammuksia. Älä tähtää päin silmiä tai kasvoja.

**H** **FIGYELMEZTETÉS!**

- Mély vízben nem használható! Kérjük, kizárólag szülői felügyelettel használja kis vízben!
- Óvd a szemeidet és az arcod! Kérjük kizárólag ivóvizet használjon! Játék után ajánlott a termék kiszáritása!
- Csak a csomagban található PLAYMOBIL lövedékeket szabad használni. Óvd a szemeidet és az arcod!

**CZ** **VAROVÁNÍ!**

- Používat pouze v mělké vodě a pod dohledem!
- Nemiřte na oči nebo na obličej! Používat jen pitnou vodu. Po hraní nechat vyschnout.
- Používejte pouze střely PLAYMOBIL, které jsou součástí dodávky. Nemiřte na oči nebo na obličej!

**EST** **HOIATUS!**

- Kasutamiseks ainult vees, kus lapse jalad ulatuvad põhja ja täiskasvanu järelevalve all.
- Ära sihi silmadesse ega näkku. Kasutada üksnes joogivett! Mängimise järel kuivatada!
- Kasutage ainult kaasaantud PLAYMOBIL'i laskemoona. Ära sihi silmadesse ega näkku.

**LV** **BRĪDINĀJUMS!**

- Lietojams tikai seklā ūdenī un uzraudzībā.
- Nevērst pret acīm vai seju. Izmantot tikai dzeramo ūdeni. Pēc spēlēšanās ļaut nožūt.
- Izmantot tikai PLAYMOBIL piegādes komplektā iekļautos šāviņus. Nevērst pret acīm vai seju.

**LT** **DĖMESIO!**

- Naudoti prižiūrint suaugusiesiems ir tokiamė gylyje, kur vaikas gali stovėti.
- Netaikyti į akis arba veidą. Naudokite tik geriamąjį vandenį. Pažaidus, išdžiovinkite.
- Naudokite tik pridedamus PLAYMOBIL šaudmenis. Netaikyti į akis arba veidą.

**SLO** **OPOZORILO!**

- Uporabljeni samo v plitvi vodi in pod nadzorom.
- Ne merite v oči ali obraz. V igračo vlivajte le pitno vodo. Po igri naj se igrača posuši.
- Uporablajte le priložene PLAYMOBIL-ove kroglice. Ne merite v oči ali obraz.

**SK** **UPOZORNENIE!**

- Používať len vo vode primerane hĺbokej dieťaťu a pod dohľadom.
- Nemieriť do očí alebo do tváre. Používať iba pitnú vodu. Po hre nechať vyschnúť.
- Používajte len náboje dodávané spolu so sadou PLAYMOBIL. Nemieriť do očí alebo do tváre.

**PL** **UWAGA!**

- Tylko do użytku w wodzie płytkiej i pod nadzorem.
- Nemierić do očí alebo do tváre. Używać tylko wodę pitną. Po zabawie pozostaw do wyschnięcia.
- Stosować tylko załączone PLAYMOBIL - kule / pociski. Nie celować w oczy i twarz.

**TR** **CY** **DİKKAT!**

- Sadece denetim altında ve sadece alçak sularda kullanın.
- Göze veya yüze doğru tutmayınız. Sadece içme suyu kullanınız. Oyundan sonra kurumaya bırakın.
- Sadece birlikte verilen PLAYMOBIL mermileri kullanınız. Göze veya yüze doğru tutmayınız.

**GR** **CY** **ΠΡΟΣΟΧΗ!**

- Να χρησιμοποιείται μόνο σε νερά όπου πατώνει το παιδί και κάτω από επίβλεψη.
- Μη σκοπεύετε τα μάτια ή το πρόσωπο. Χρησιμοποιείτε μόνο νερό βρύσης. Μόλις τελειώσετε, αφήστε το παιχνίδι να στεγνώσει εντελώς.
- Να χρησιμοποιούνται αποκλειστικά τα βλήματα της PLAYMOBIL που περιέχονται στη συσκευασία. Μη σκοπεύετε τα μάτια ή το πρόσωπο.

**CN** **警告!**

- 可供孩子在水中使用，但必须在有人监护的情况下。
- 禁止瞄准眼睛或者脸。仅使用饮用水。玩耍后要干燥。
- 仅能用PLAYMOBIL的炮弹。禁止瞄准眼睛或脸。

30 45 8360

30 45 8350

**2x**  
30 07 0100

30 22 5480

30 07 6930

30 07 6920

**3x**

30 61 9280

**2x**

30 02 6020

2x 30 06 4980

30 00 8980

30 02 6020

30 28 2060

30 00 7022

30 63 6640

30 00 4502

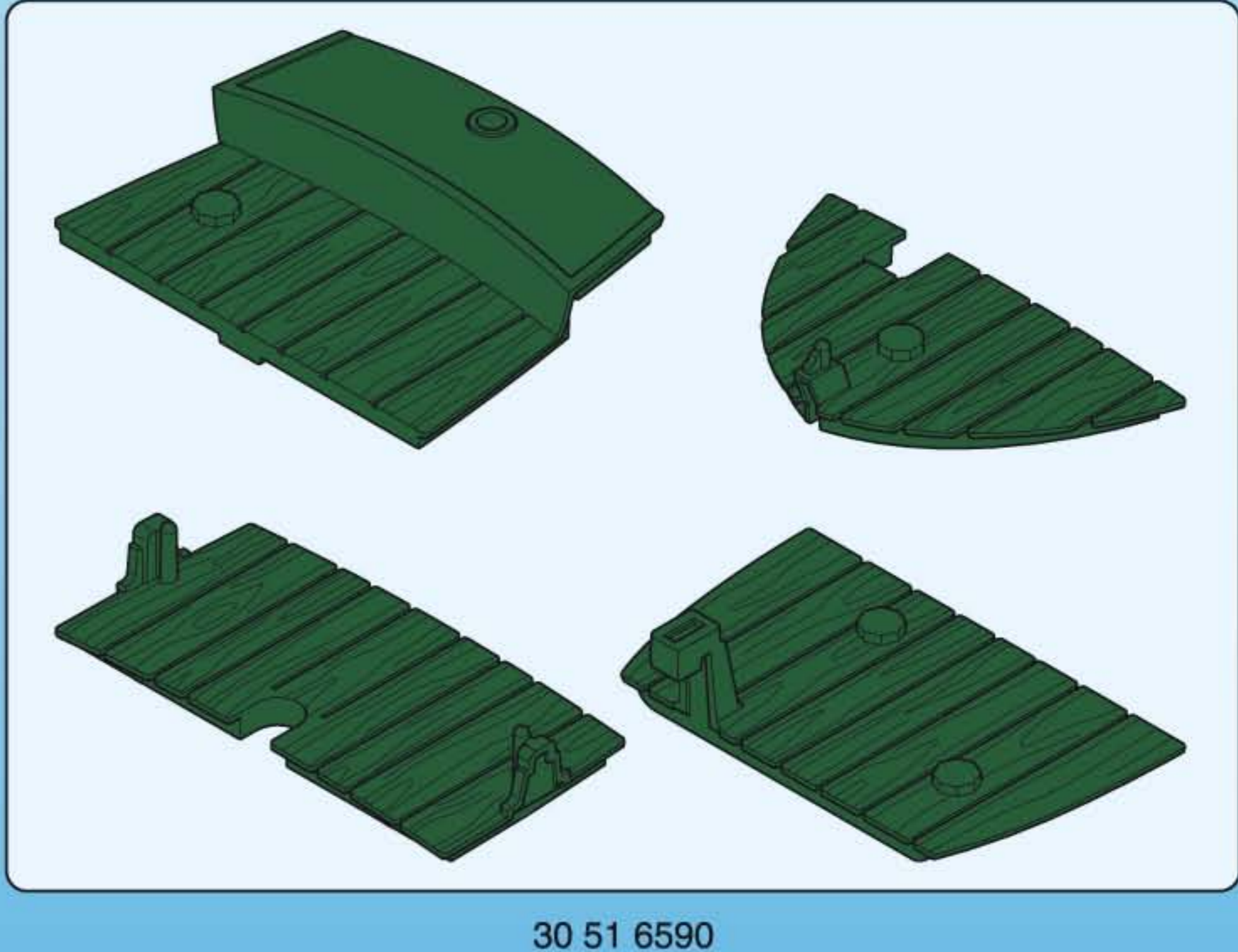
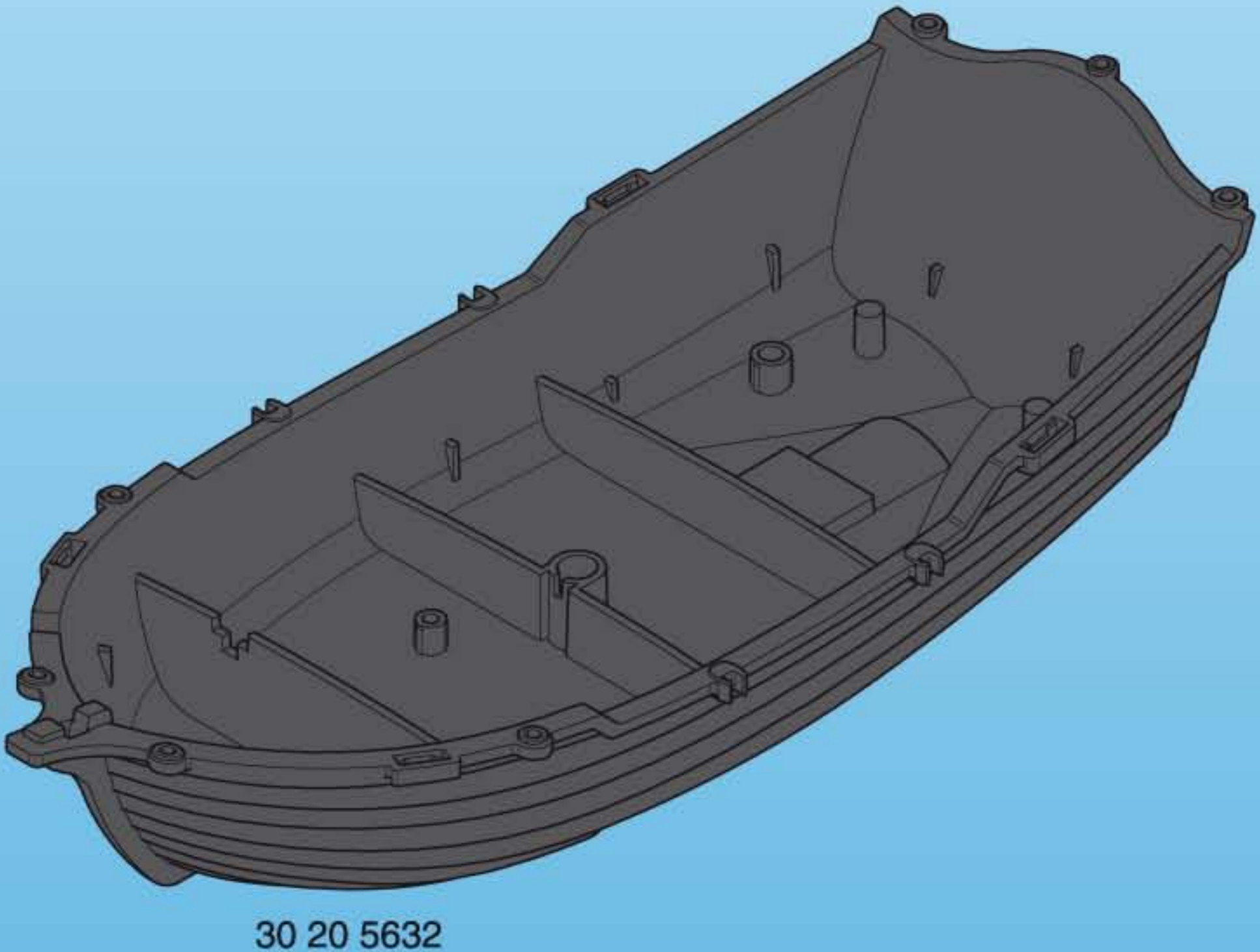

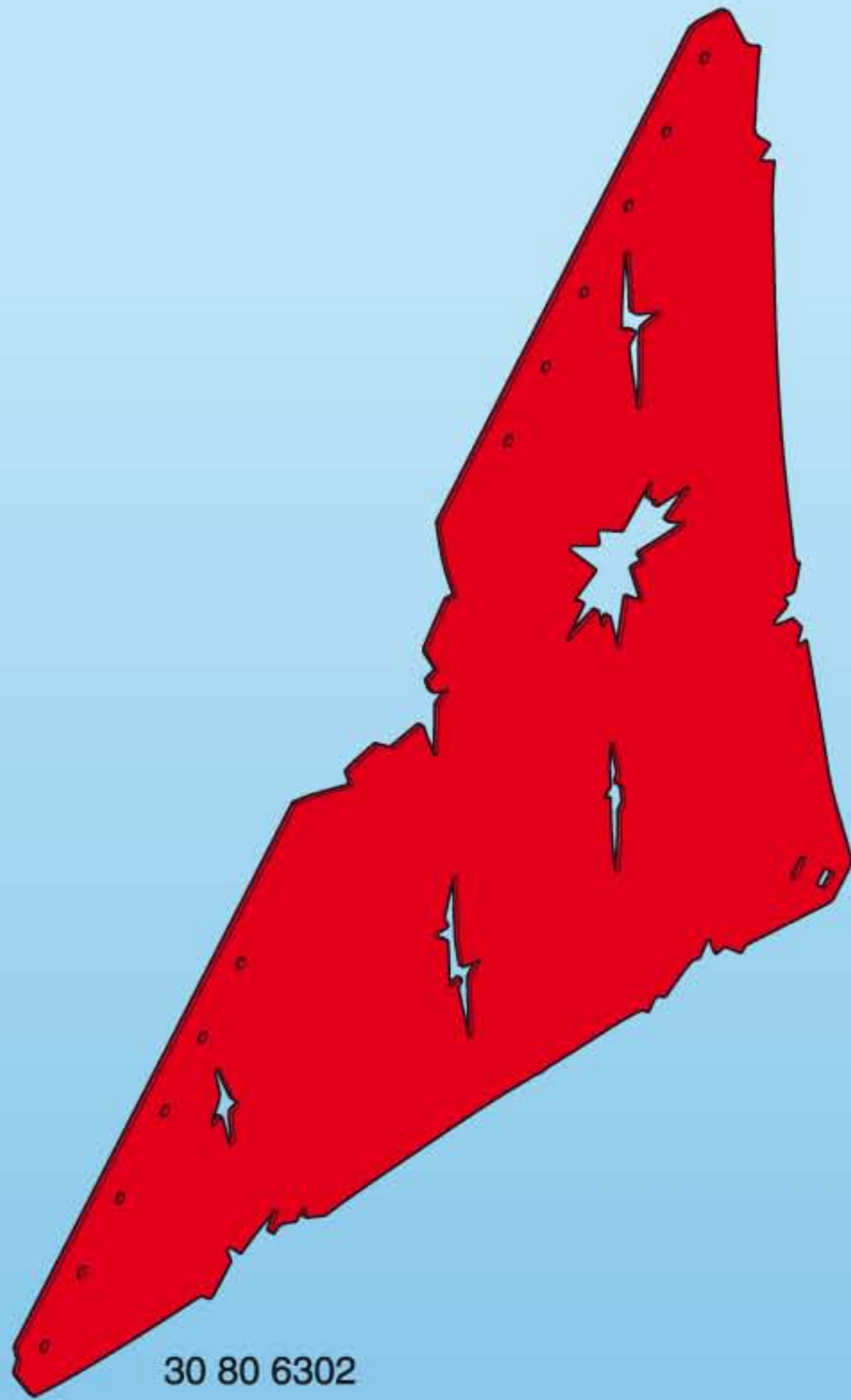

30 80 6302

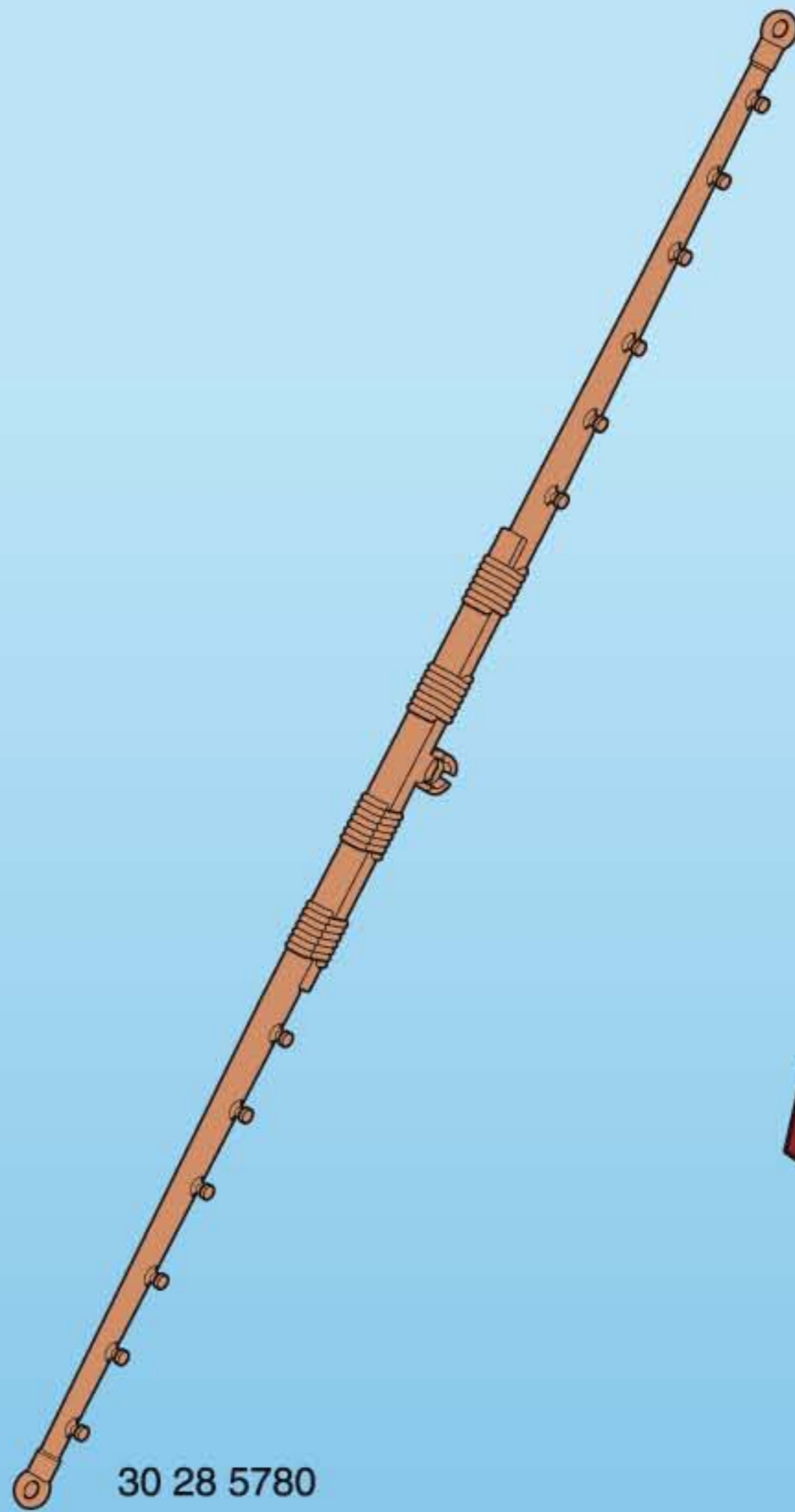

30 28 5780

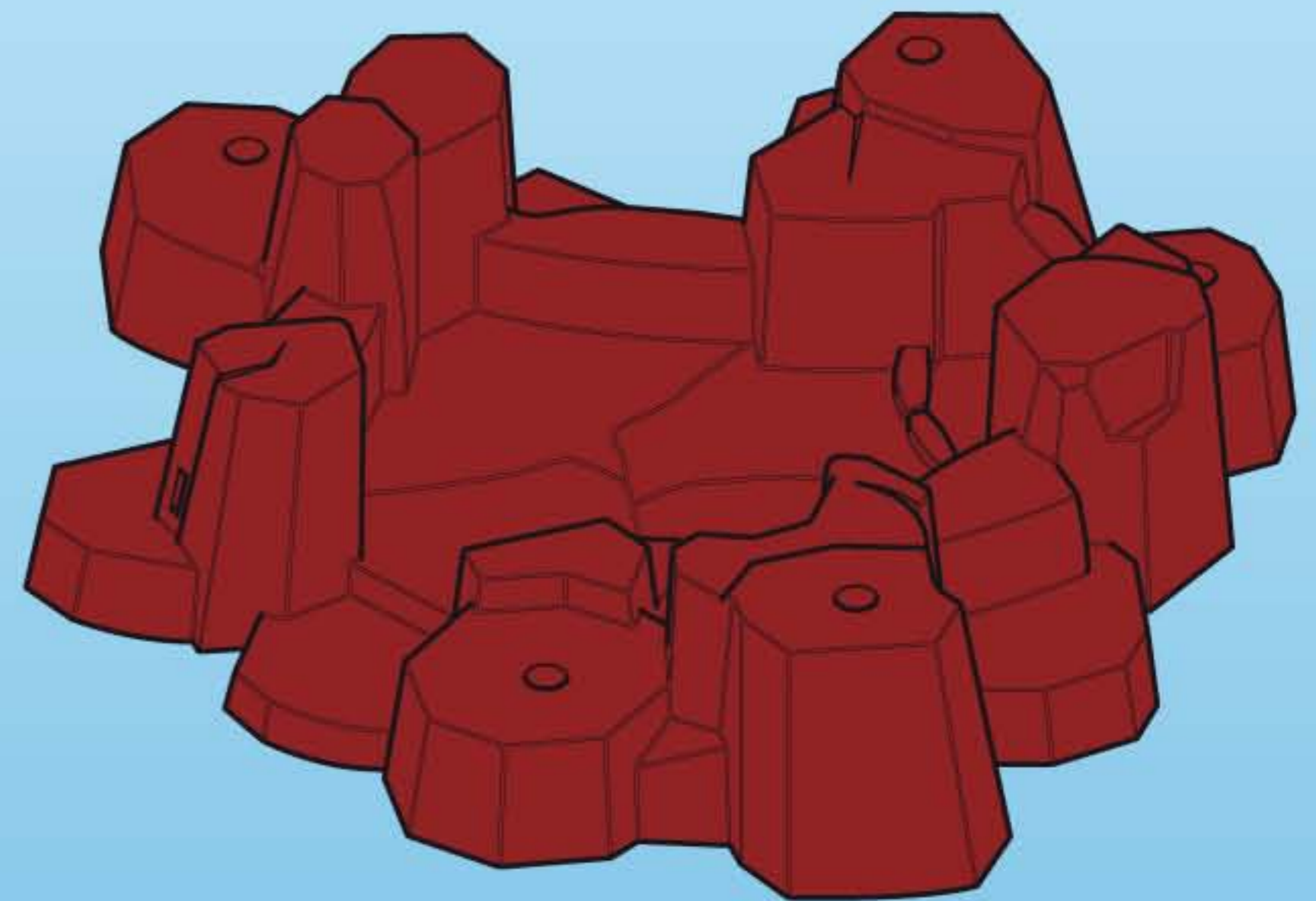

30 20 5622

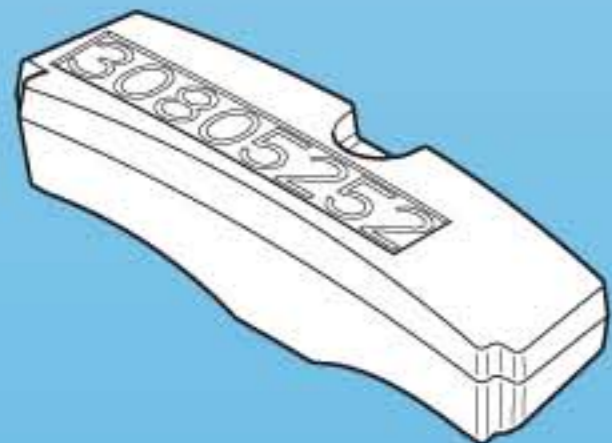

30 80 5252



30 20 5652



30 28 2590



30 63 9442



30 63 9452

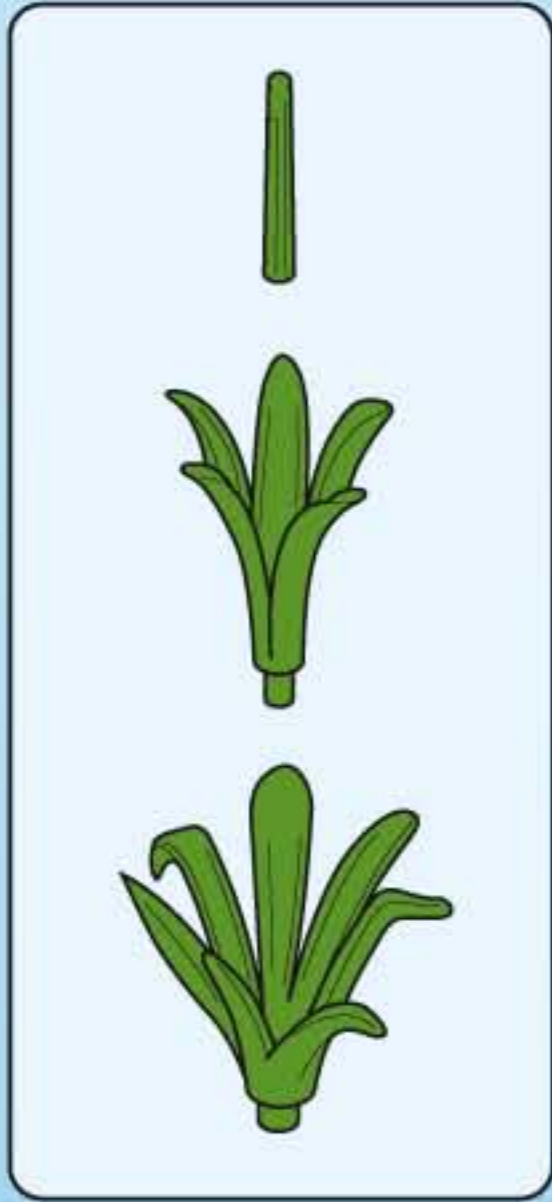

2x 30 60 7870

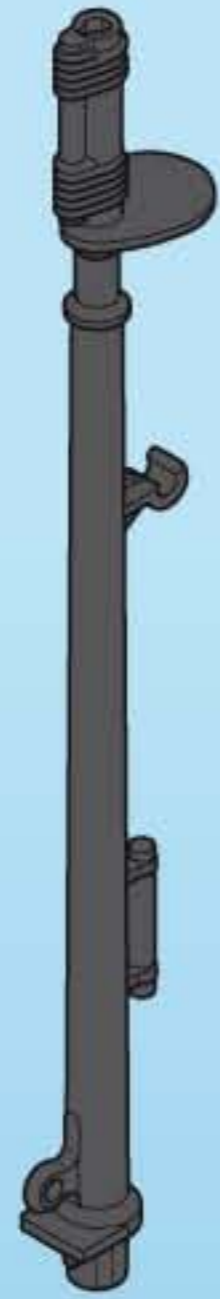

30 20 5642



30 25 9290

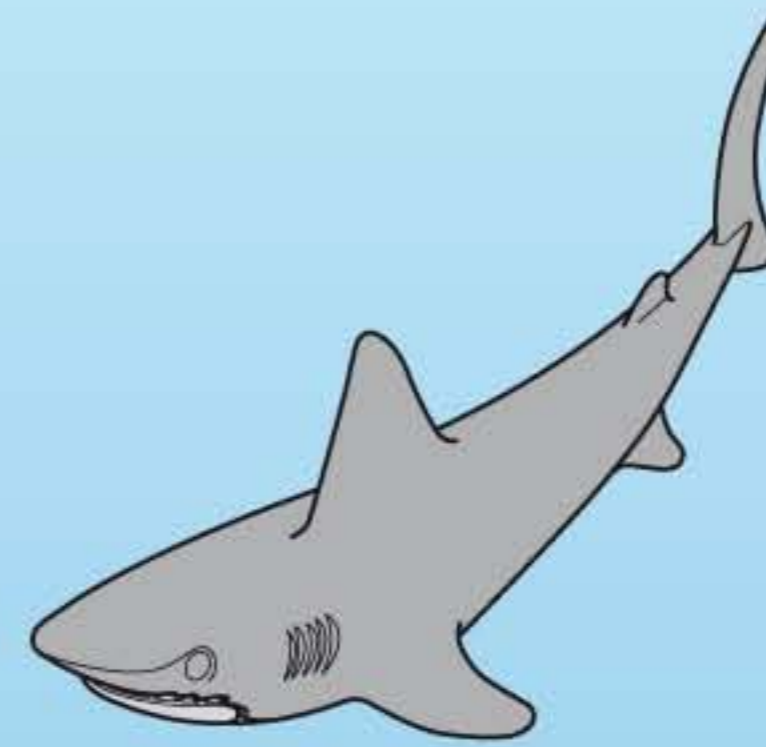

30 66 9430



30 21 9240



30 20 5662



30 21 5510



30 21 9250

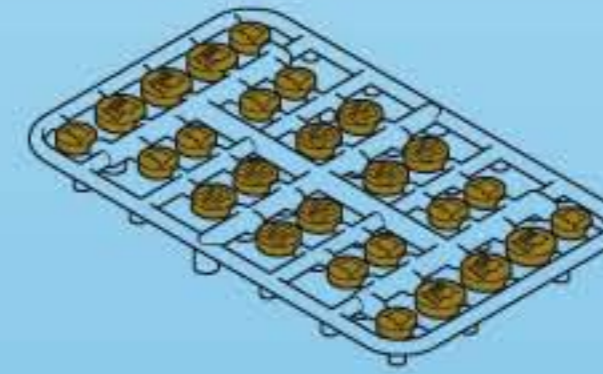

3x 30 61 3730



30 21 9230

35 cm (13,8 inch)



30 88 0472

17 cm (6,7 inch)



4x 30 88 7672

60 cm (23,6 inch)



30 80 2950



30 09 3670



30 09 1760



30 09 5650



30 83 0360

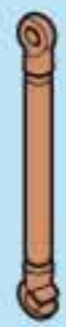

30 28 5810



4x 30 28 2120



30 06 6070



30 21 0920



30 07 9190



30 09 7570



30 28 1630



4x 30 09 5440



30 28 2570



30 20 5830



3x 30 28 6890



4x 30 20 5682



3x 30 08 9680



30 20 5672



2x 30 20 5702



30 20 5692



2x 30 24 8230

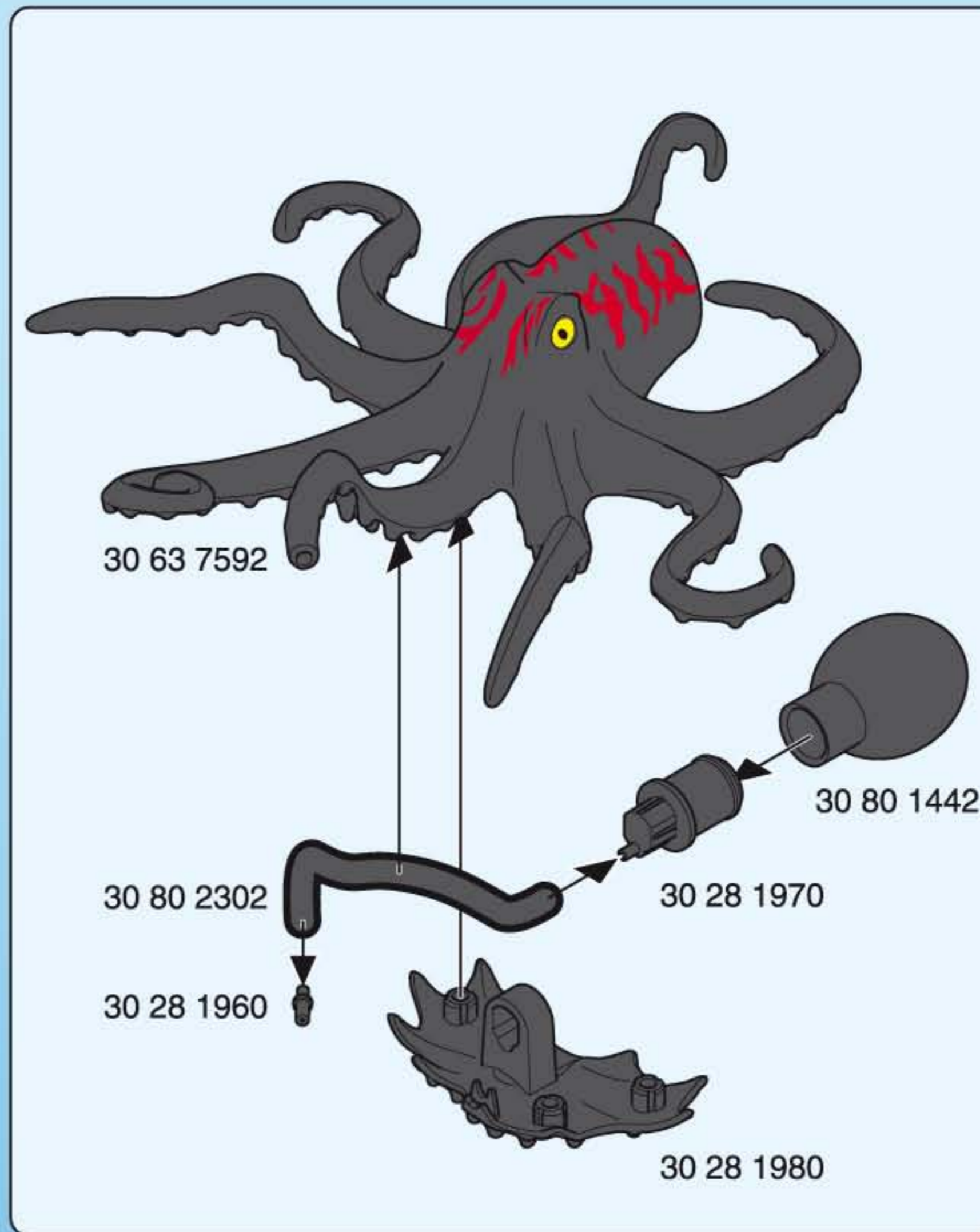

Serviceadressen finden Sie in allen Playmobil-Prospekten

Addresses of Customer Service Departments are shown in all Playmobil catalogues

L'adresse du service consommateurs est indiquée dans tous les catalogues Playmobil

Troverete gli indirizzi dei centri di assistenza in tutti i cataloghi Playmobil

In alle PLAYMOBIL catalogi vindt u het adres van onze klantendienst.

Las Direcciones de los Departamentos de Servicio al Consumidor se encuentran en todos los catálogos Playmobil

Η διεύθυνση του Γραφείου Εξυπηρέτησης Πελατών είναι καταχωρημένη σε όλους τους καταλόγους Playmobil

pronounce: plāy-mō-bēel