

playmobil®

5803



WARNING:

CHOKING HAZARD
Contains a small ball and small parts.
Not for children under 3 years.

"Ne concerne que les USA"



Wichtige Unterlagen, bitte sorgfältig aufbewahren !
Important documents keep carefully !
Documents importants conservez avec soin !

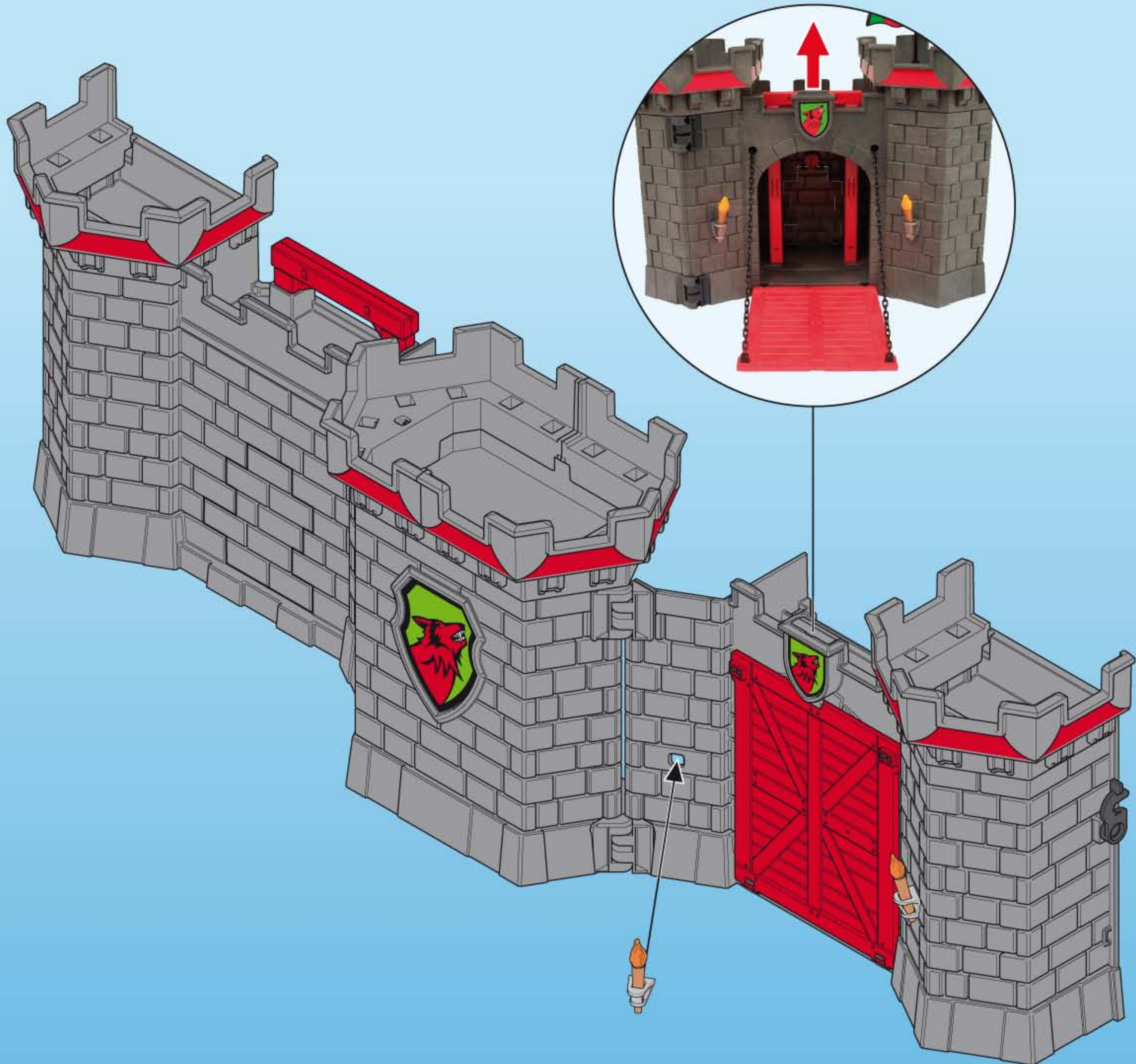

1



2x

-  30 07 6930
-  30 07 6920
-  30 22 4460

2

2x



40 66 0000

30 21 3850

This inset shows a red and green flag on a black pole. The top part of the pole is labeled '40 66 0000' and the bottom part is labeled '30 21 3850'.

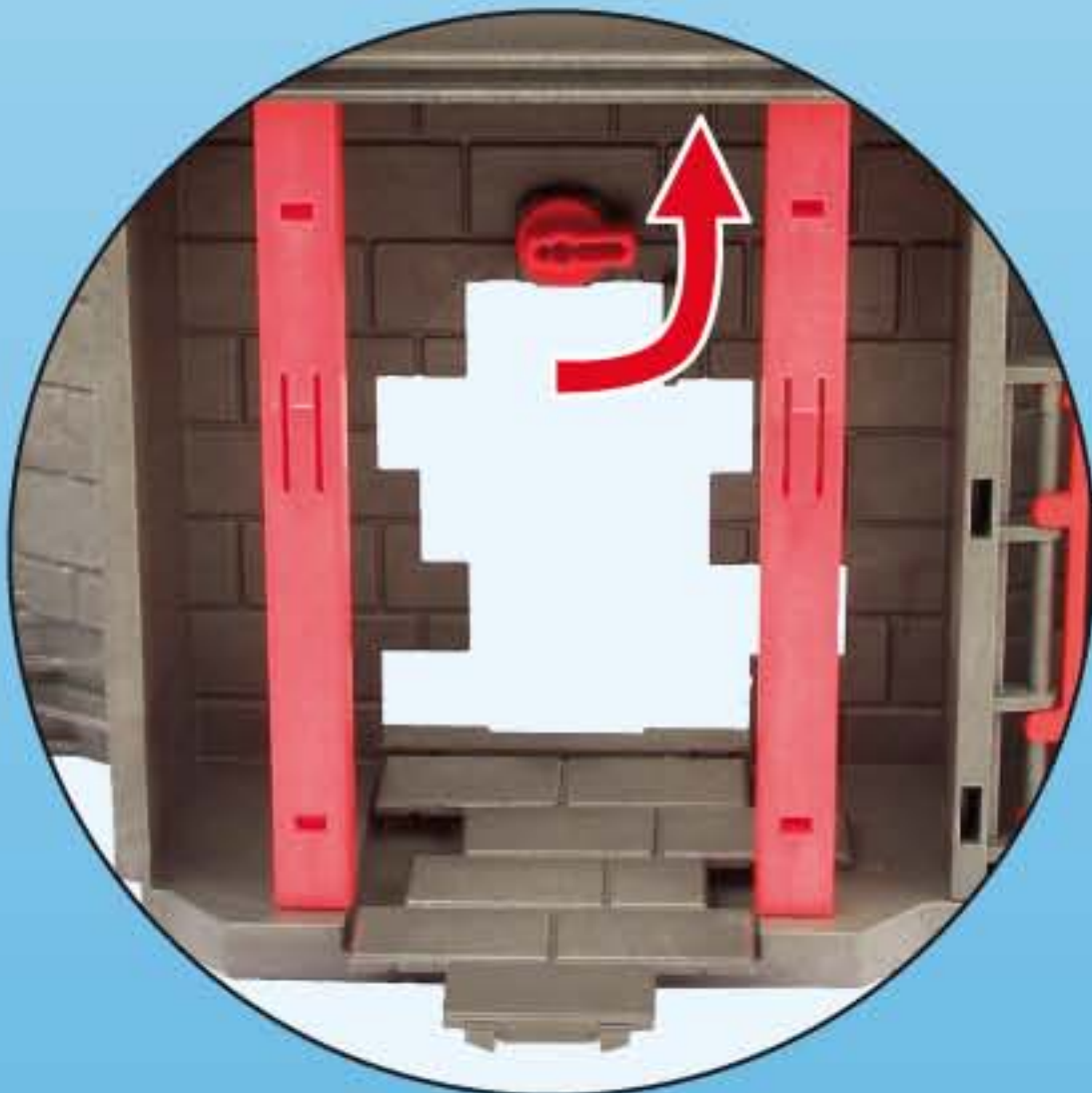
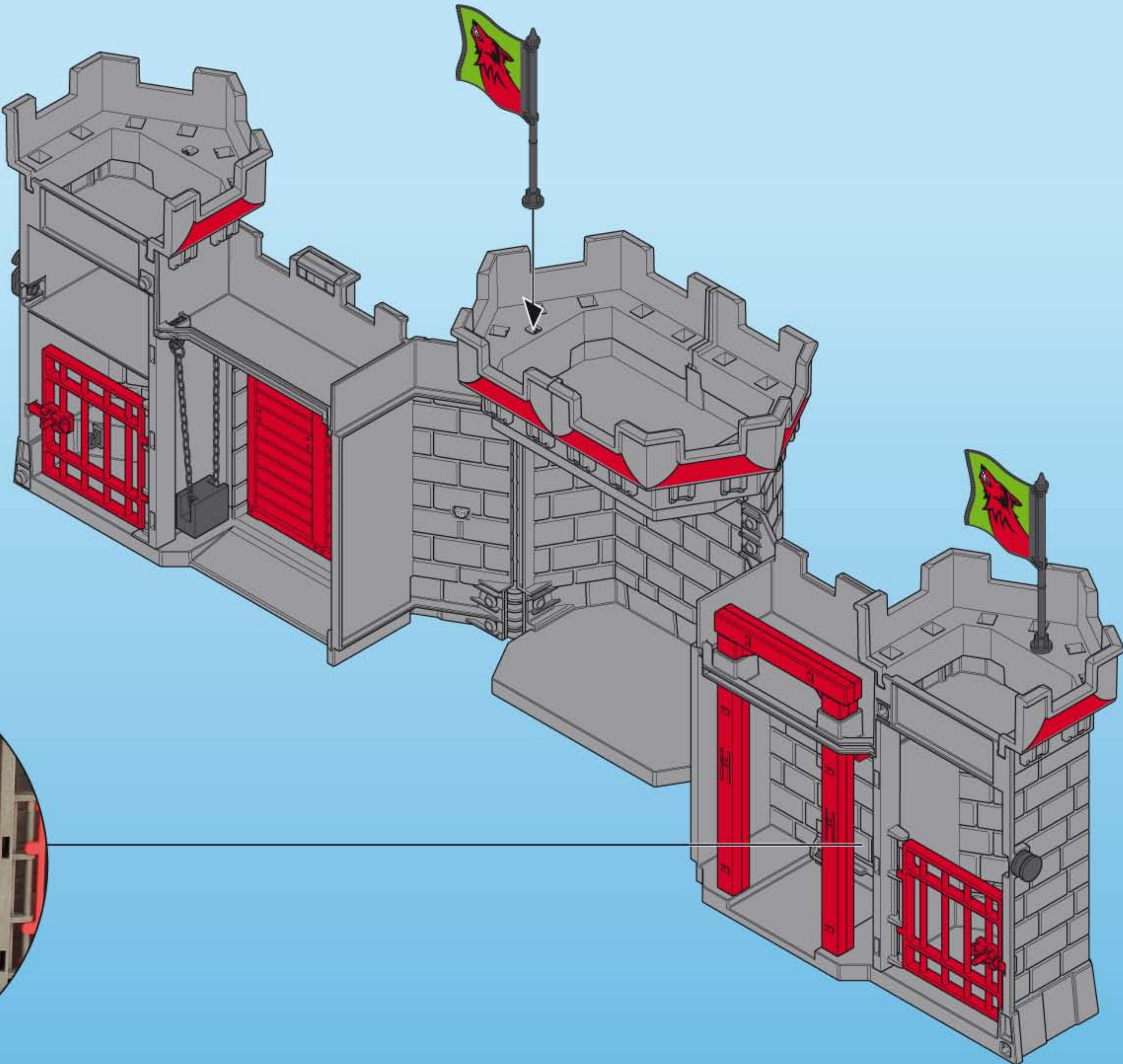

1

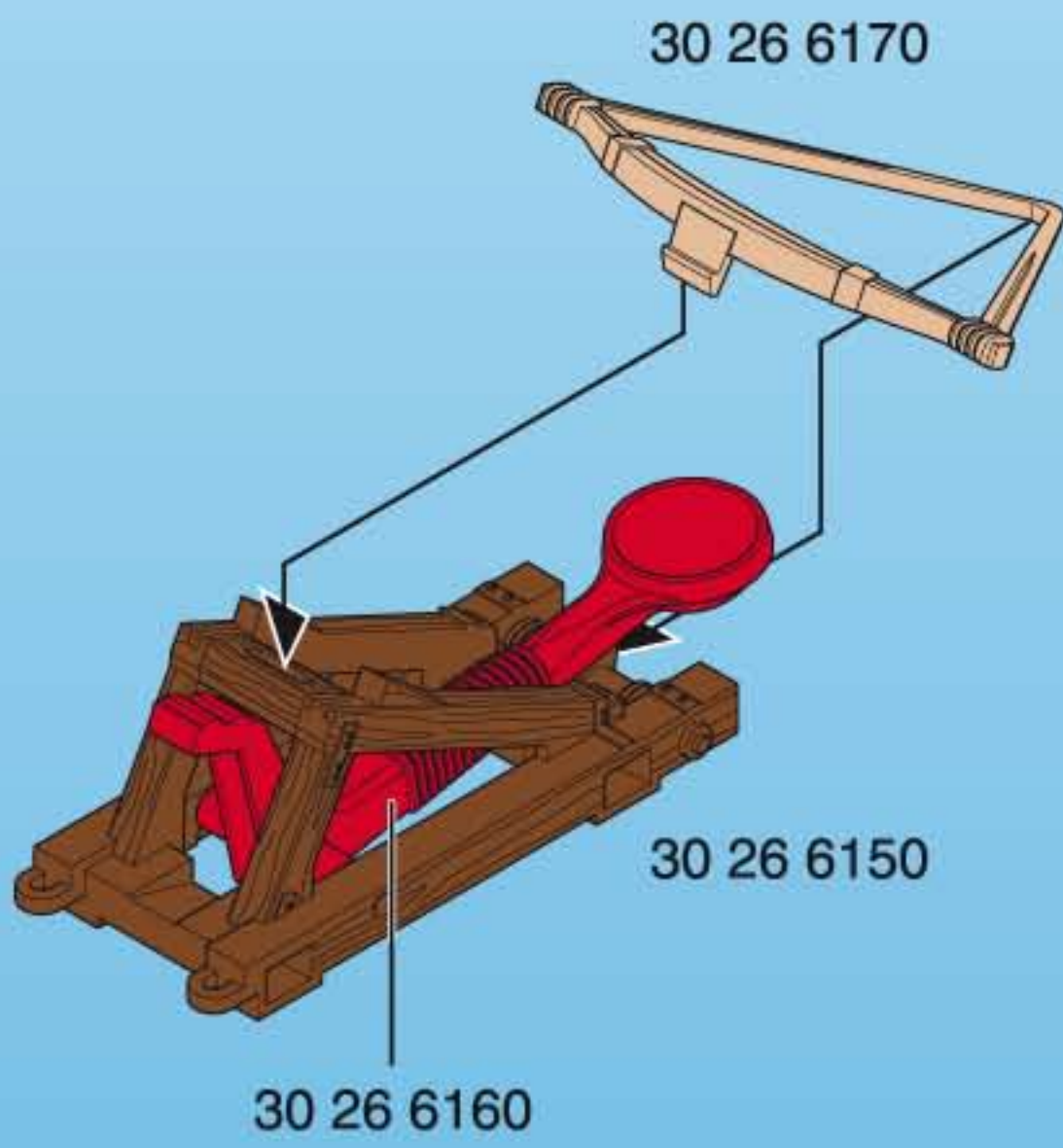

2

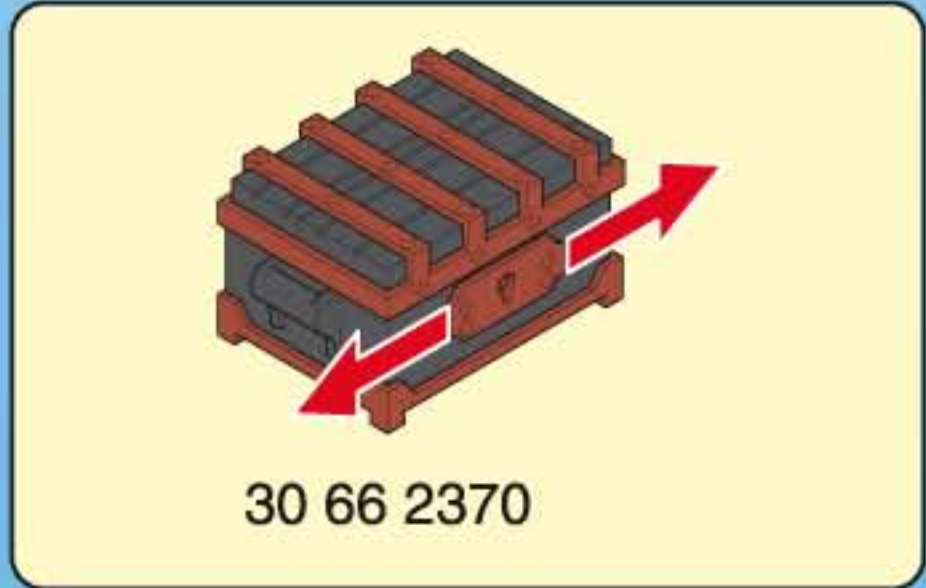
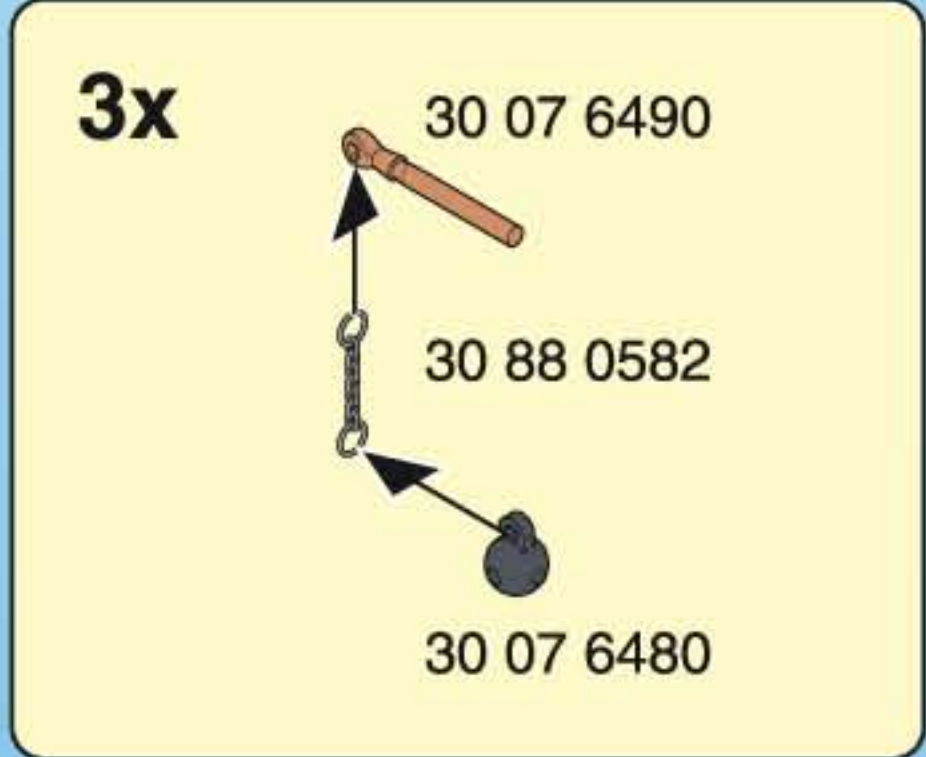
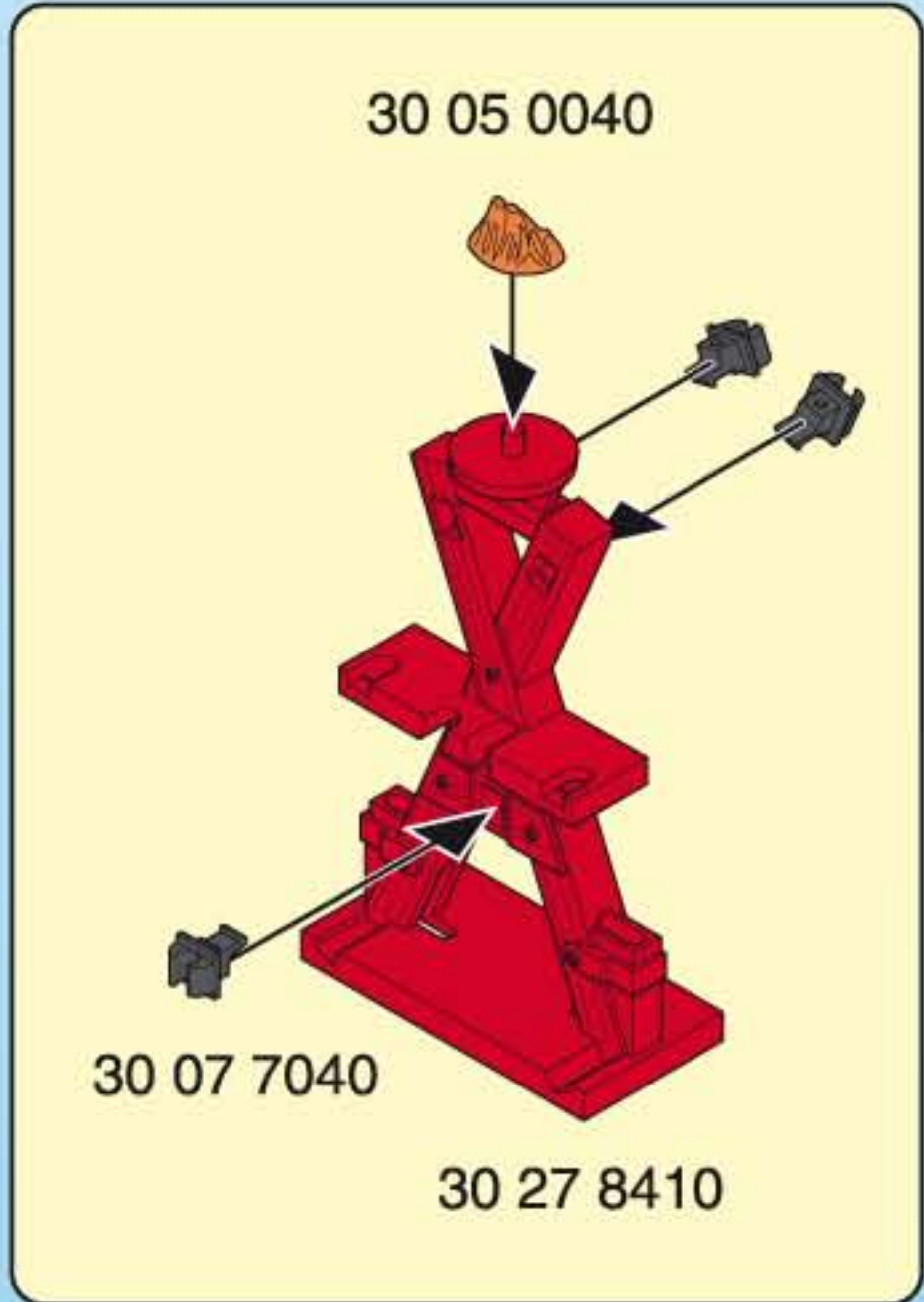
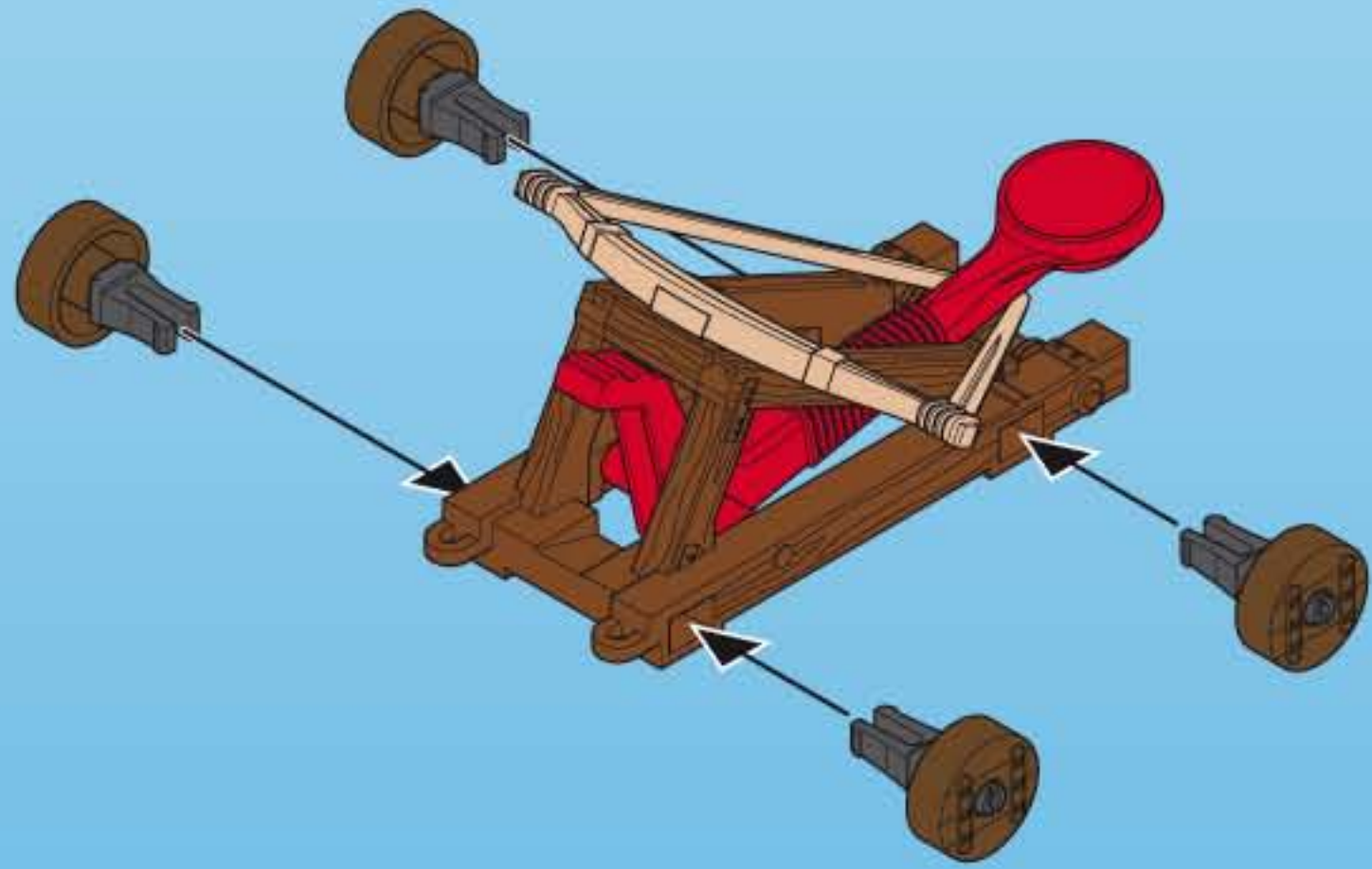
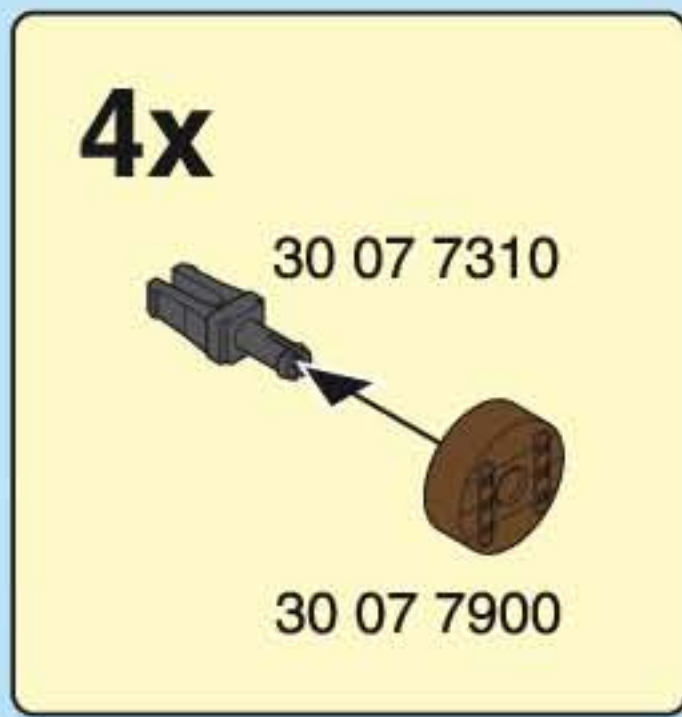

3

D A CH L **WARNING!**

Nur PLAYMOBIL Geschosse verwenden. Nicht auf Augen oder Gesicht zielen.

USA GB CDN M **WARNING!**

Only use PLAYMOBIL projectile ! Do not aim at eyes or face.

F CDN B L CH **ATTENTION !**

Utiliser uniquement les projectiles PLAYMOBIL ! Ne pas viser les yeux ou le visage

E MEX **¡ATENCIÓN!**

Usar sólo las bolas de cañón de PLAYMOBIL. No se ha de apuntar a los ojos ni a la cara.

NL B **OPGELET!**

Enkel PLAYMOBIL kanonskogels gebruiken! Niet op ogen of gezicht richten.

I CH **ATTENZIONE!**

Da usare soltanto palle di canone PLAYMOBIL. Non mirare agli occhi o al viso.

P **ATENÇÃO!**

Usar só as bolas de canhão de PLAYMOBIL. Não apontar para os olhos ou face.

DK **ADVARSEL!**

Brug kun PLAYMOBIL kanonkugler! Sigt ikke mod øjne eller ansigt.

N **ADVARSEL!**

Bruk kun Playmobil kanon kuler! Sikt ikke på ansikt eller øyne.

S FIN **VARNING!**

Använd endast PLAYMOBILS kanonkuler! Sikta ej mot ögonen eller ansiktet.

FIN **VAROITUS!**

Käytä ainoastaan PLAYMOBIL -tykinkuulia! Älä tähtää päin silmiä tai kasvoja.

H **FIGYELEM!**

Kizárólag a PLAYMOBIL ágyúgolyókat használ! Övd a szemeidet és az arcod!

CZ **VAROVANÍ!**

Používat jenom dělové koule PLAYMOBILU. Nemiřte na oči nebo na obličej!

EST **ETTEVAATUST!**

Kasutage ainult PLAYMOBIL kahurikuule. Ära sihi silmadesse ega näkku.

LV **BRĪDINĀJUMS!**

Izmantot tikai PLAYMOBIL lielgabala bumbiņas. Nevērst pret acīm vai seju.

LT **PERSPĖJIMAS!**

Naudokite tik PLAYMOBIL patrankos sviedinius. Netaikyti į akis arba veidą.

SLO **OPOZORILO!**

Uporabljajte samo PLAYMOBIL topovske kroglice! Ne merite v oči ali obraz.

SK **UPOZORNENIE!**

Používajte len delové gule určené pre danú sadu PLAYMOBIL. Nemieriť do očí alebo do tváre.

PL **UWAGA!**

Stosować wyłącznie pociski firmy PLAYMOBIL. Niemierić do ości albo do tváre.

TR CY **UYARI!**

Sadece PLAYMOBIL top mermileri kullanınız. Göze veya yüze doğru tutmayınız.

GR CY **ΠΡΟΣΟΧΗ!**

Στα κανόνια PLAYMOBIL να χρησιμοποιείτε αποκλειστικά και μόνο τις οβίδες PLAYMOBIL. Μη σκοπεύετε τα μάτια ή το πρόσωπο.

1

30 24 7530

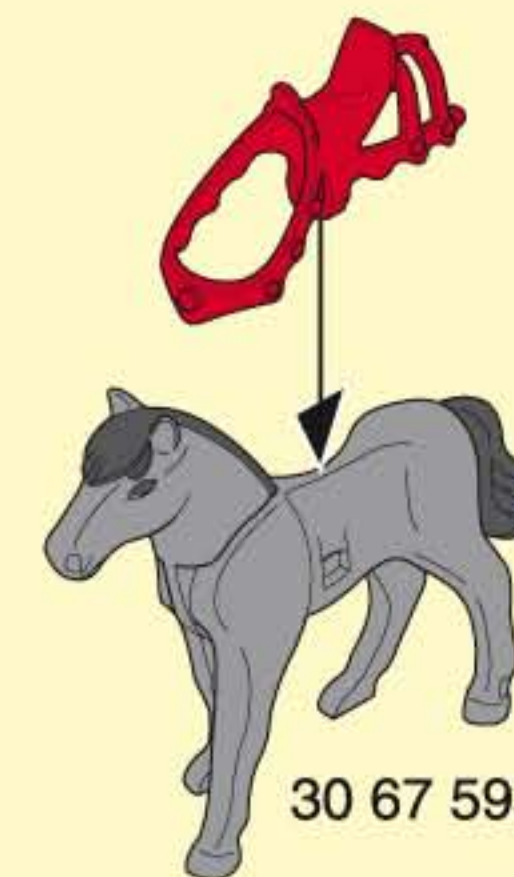

30 67 5930

2

30 24 7550



3

30 24 7540

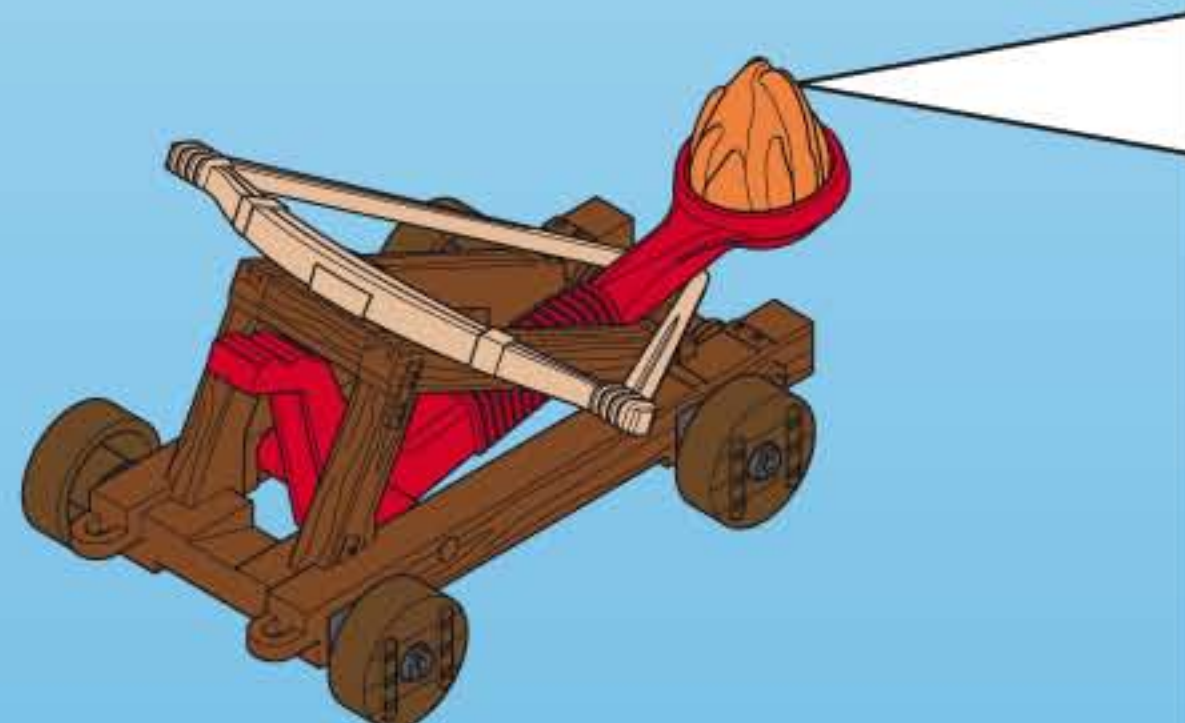

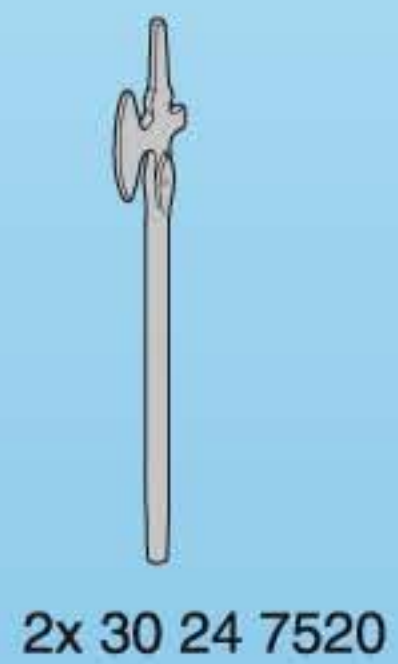
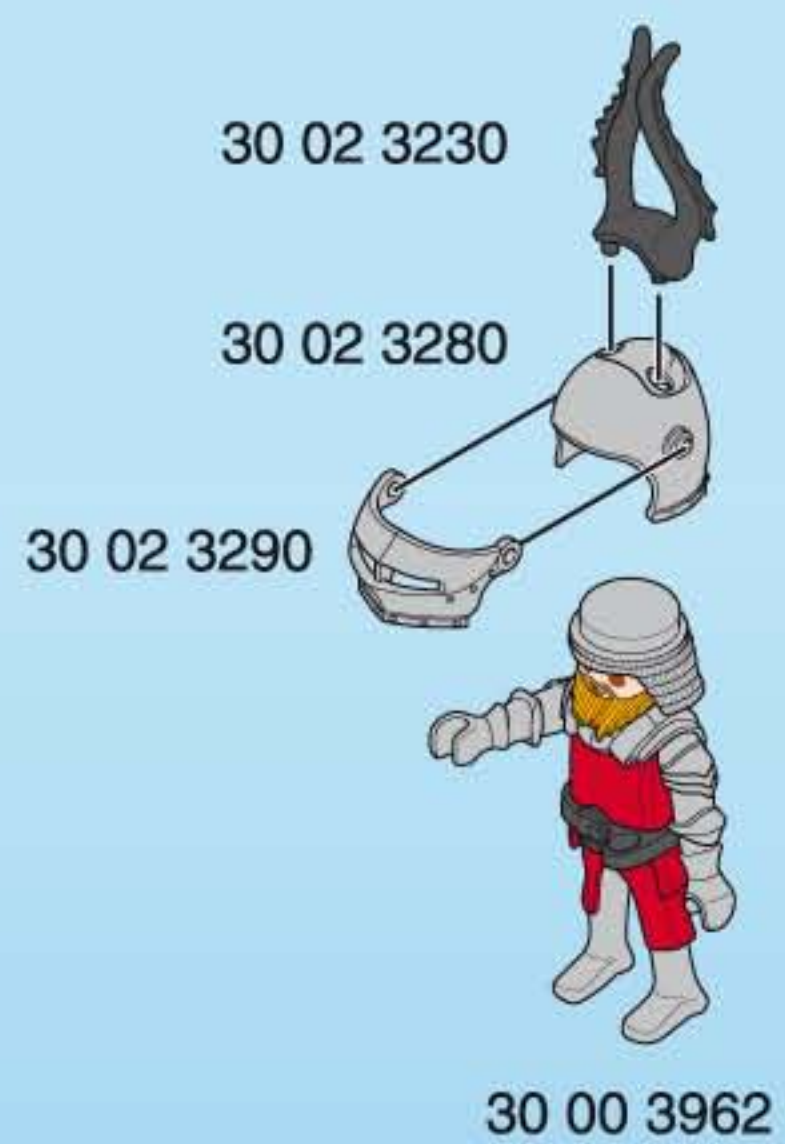
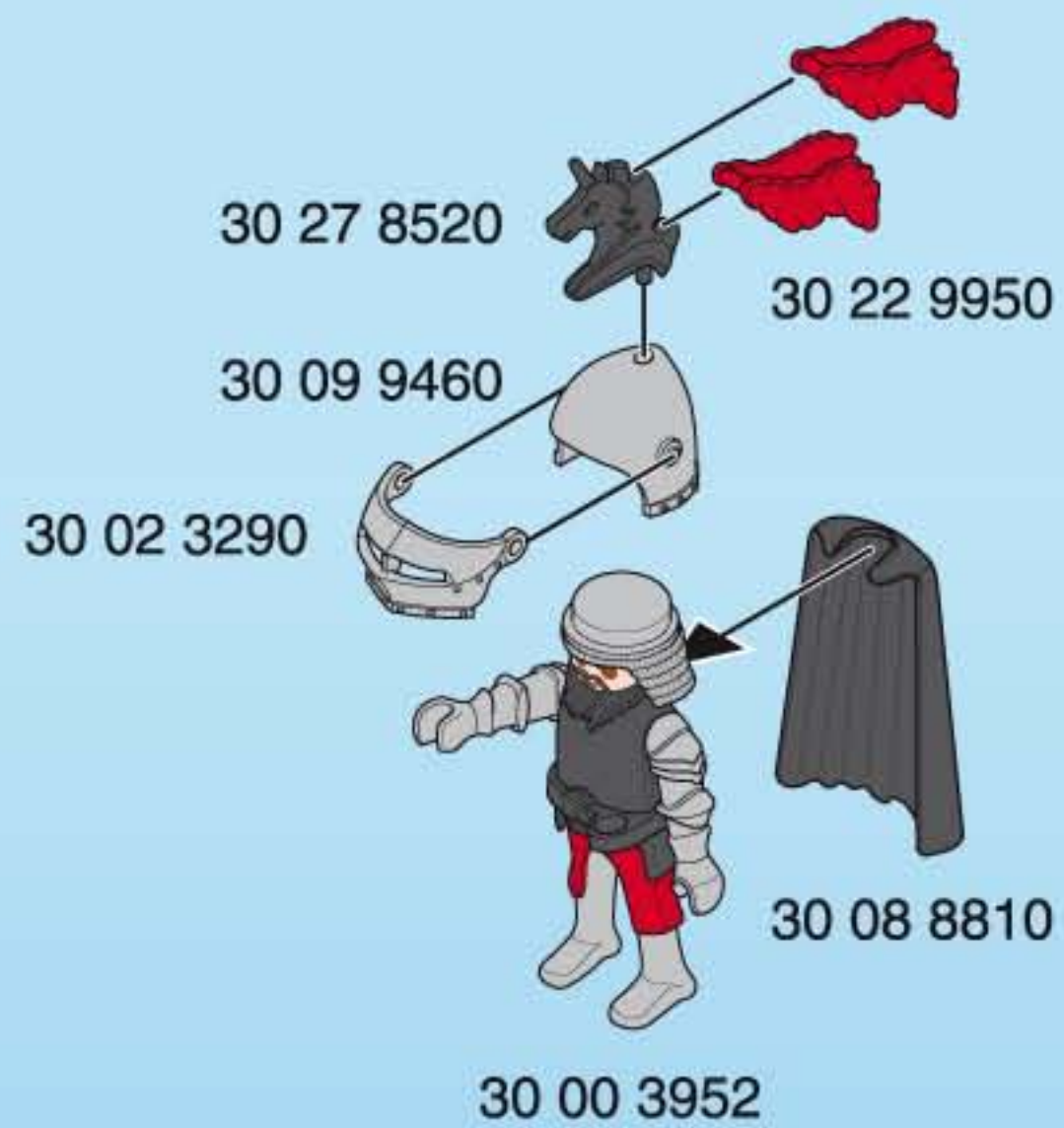

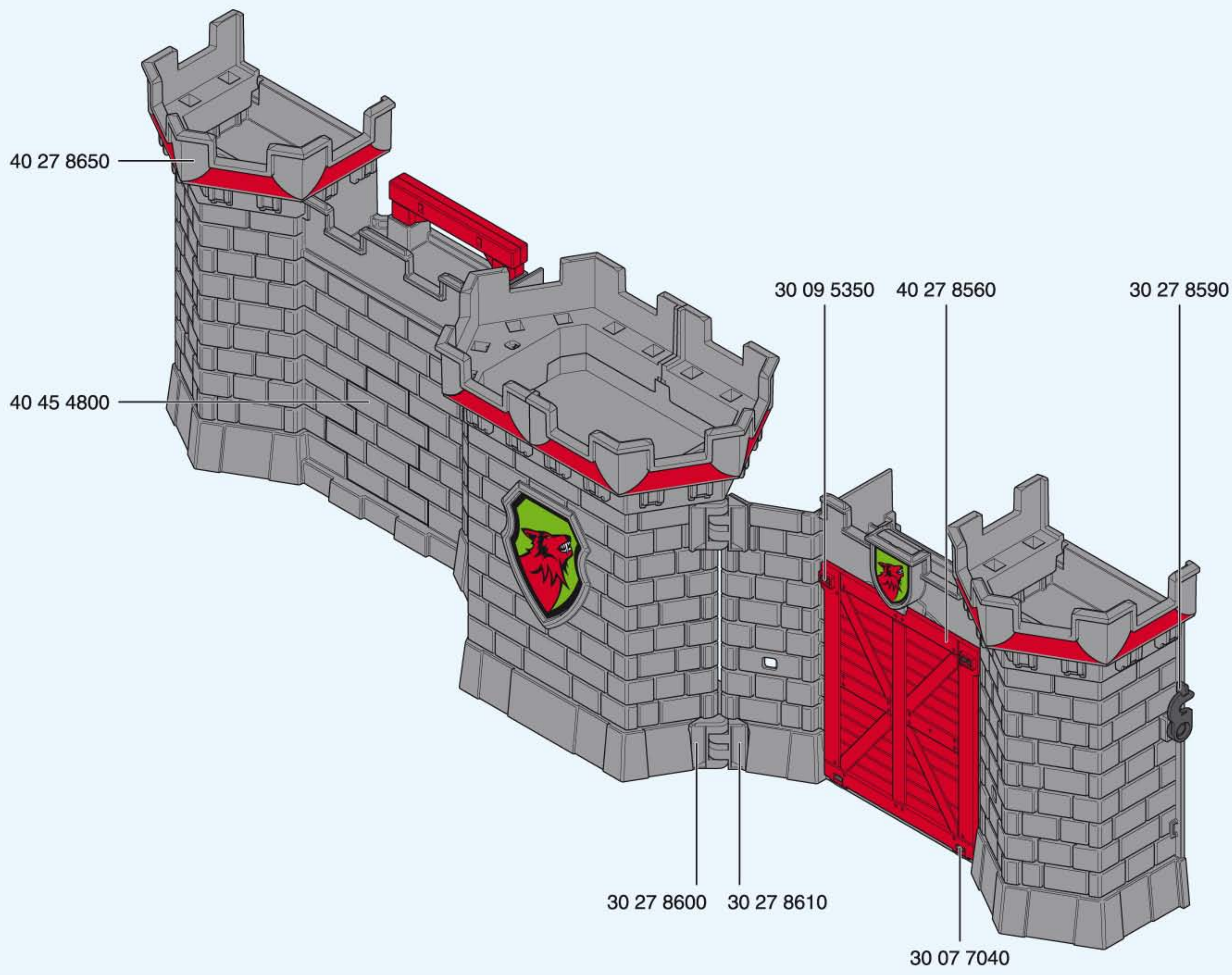

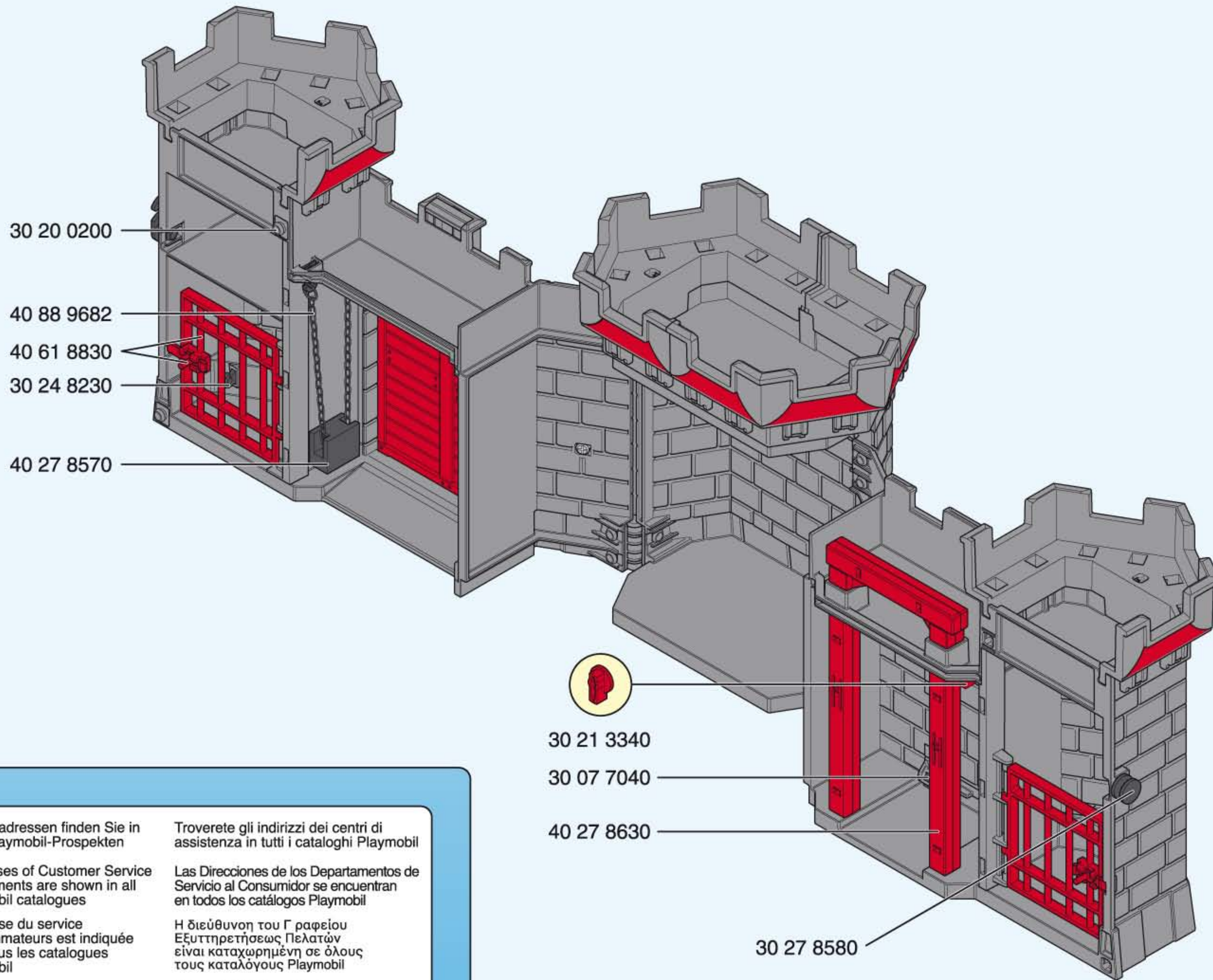

Serviceadressen finden Sie in allen Playmobil-Prospekten

Addresses of Customer Service Departments are shown in all Playmobil catalogues

L'adresse du service consommateurs est indiquée dans tous les catalogues Playmobil

Troverete gli indirizzi dei centri di assistenza in tutti i cataloghi Playmobil

Las Direcciones de los Departamentos de Servicio al Consumidor se encuentran en todos los catálogos Playmobil

Η διεύθυνση του Γραφείου Εξυπηρέτησεως Πελατών είναι καταχωρημένη σε όλους τους καταλόγους Playmobil
pronounce: plāy-mō-bēēl