

playmobil®

5736
4424



WARNING: CHOKING HAZARD

Contains a small ball and small parts.
Not for children under 3 years.

"Ne concerne que les USA"

Wichtige Unterlagen, bitte sorgfältig aufbewahren!
Important documents keep carefully!
Documents importants conservez avec soin!
Belangrijke documenten, bewaar deze zorgvuldig!



D A CH L B **ACHTUNG!** Nur unter Aufsicht und nur in flachem Wasser benutzen.

USA GB CDN M IRL **WARNING!** Only to be used in water in which the child is within depth and under supervision

F CDN B L CH **ATTENTION!** À n'utiliser qu'en eau où l'enfant a pied et sous surveillance.

E MEX **ADVERTENCIA!** Se deberá utilizar solamente en el agua, donde el niño haga pie y bajo vigilancia.

NL B **WAARSCHUWING!** Alleen gebruiken onder toezicht, in water waarin het kind kan staan.

I CH **ATTENZIONE!** Utilizzare solo in acque dove il bambino tocca con i piedi e sotto sorveglianza.

P **AVISO!** Utilizar apenas em águas em que a criança tenha pé e sob vigilância.

DK **ADVARSEL!** Må kun anvendes under opsyn og på vanddybder, hvor barnet kan bunde.

N **ADVARSEL!** Skal kun brukes i vann som ikke er for dypt for barnet, og der barnet er under tilsyn.

S FIN **VARNING!** Får endast användas på grunt vatten och under uppsikt av vuxen.

FIN **VAROITUS!** Käytetään ainoastaan matalassa vedessä, jossa lapsi voi seistä ja on aikuisen valvonnassa.

H **FIGYELMEZTETÉS!** Mély vízben nem használható! Kérjük, kizárólag szülői felügyelettel használja kis vízben!

CZ **VAROVÁNÍ!** Používat pouze v mělké vodě a pod dohledem!

EST **HOIATUS!** Kasutamiseks ainult vees, kus lapse jalad ulatuvad põhja ja täiskasvanu järelevalve all.

LV **BRIDINĀJUMS!** Lietojams tikai sekļā ūdenī un uzraudzībā.

LT **DĖMESIO!** Naudoti prižiūrint suaugusiesiems ir tokiame gylyje, kur vaikas gali stovėti.

SLO **OPOZORILO!** Uporabljati samo v plitvi vodi in pod nadzorom.

SK **UPOZORNENIE!** Používať len vo vode primerane hĺbokej dieťaťu a pod dohľadom.

PL **UWAGA!** Tylko do użytku w wodzie płytkiej i pod nadzorem.

TR CY **DİKKAT!** Sadece denetim altında ve sadece alçak sularda kullanın.

GR CY **ΠΡΟΣΟΧΗ!** Να χρησιμοποιείται μόνο σε νερά όπου πατώνει το παιδί και κάτω από επίβλεψη.

RO **AVERTIZARE!** Se folosește doar sub supraveghere și doar în apă mică.

BG **ПРЕДУПРЕЖДЕНИЕ!** Да се използва само под наблюдение и в плитки води.

CN **警告!** 可供孩子在水中使用，但必须在有人监护的情况下。

1

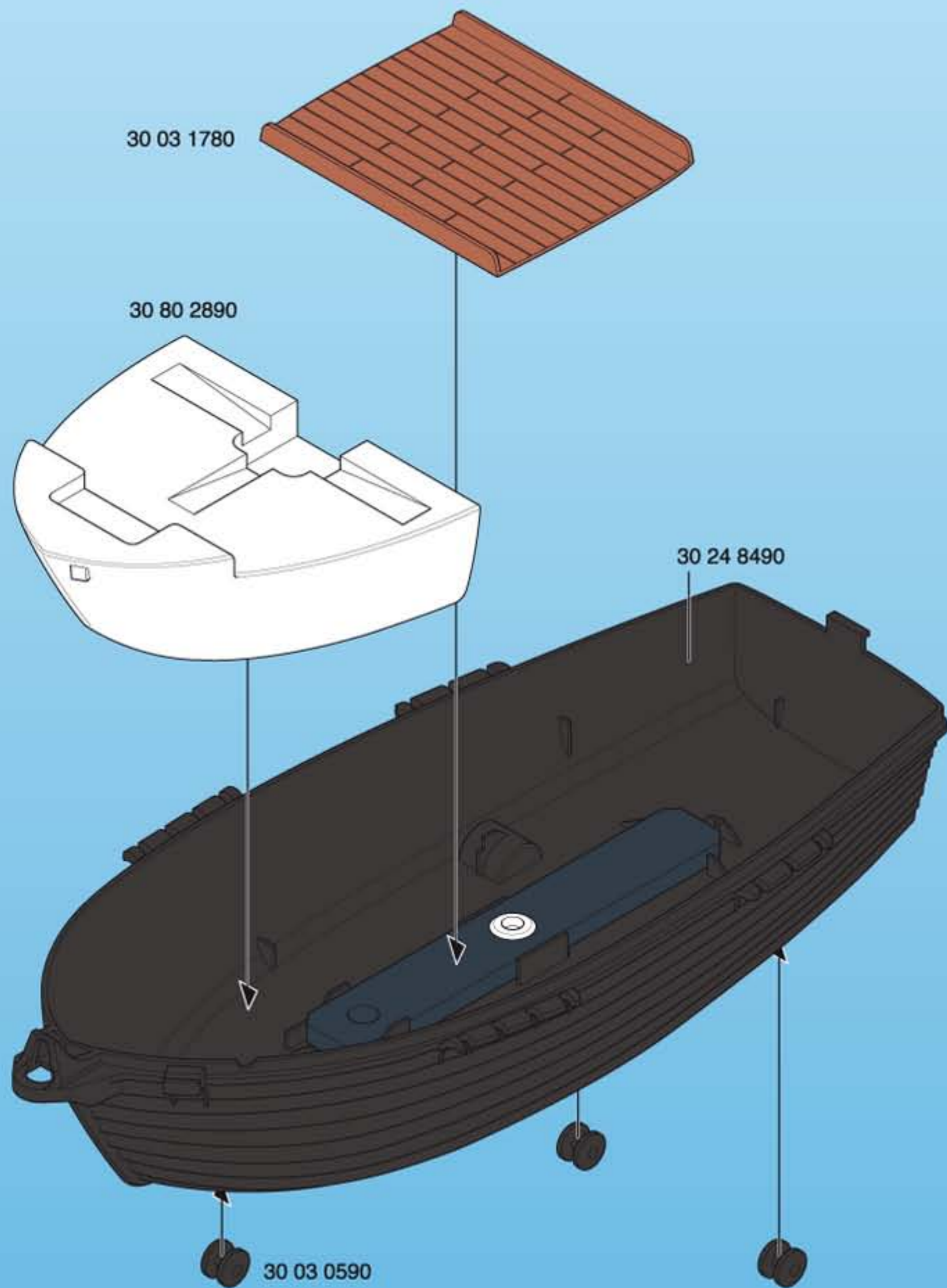

2

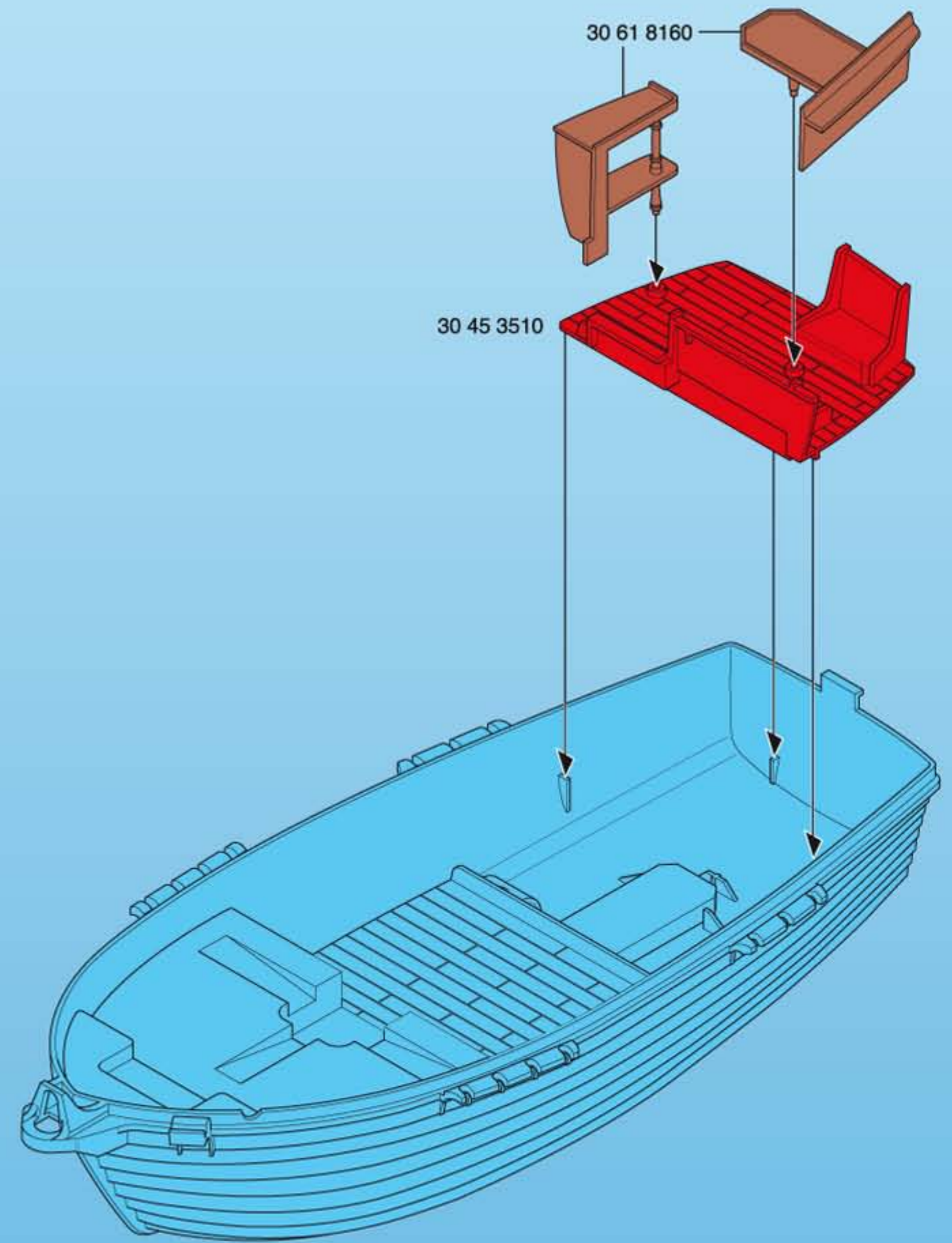

3

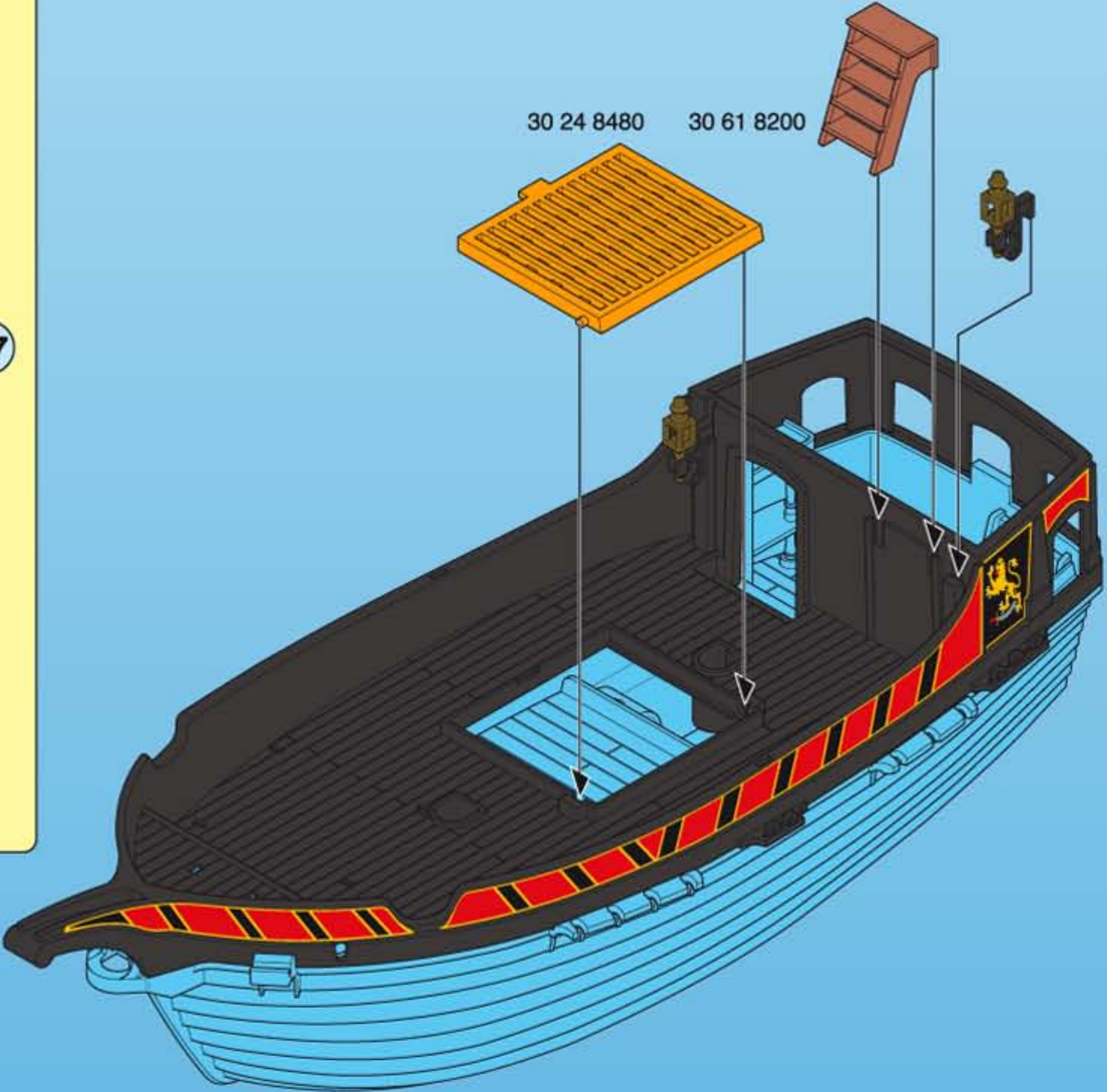
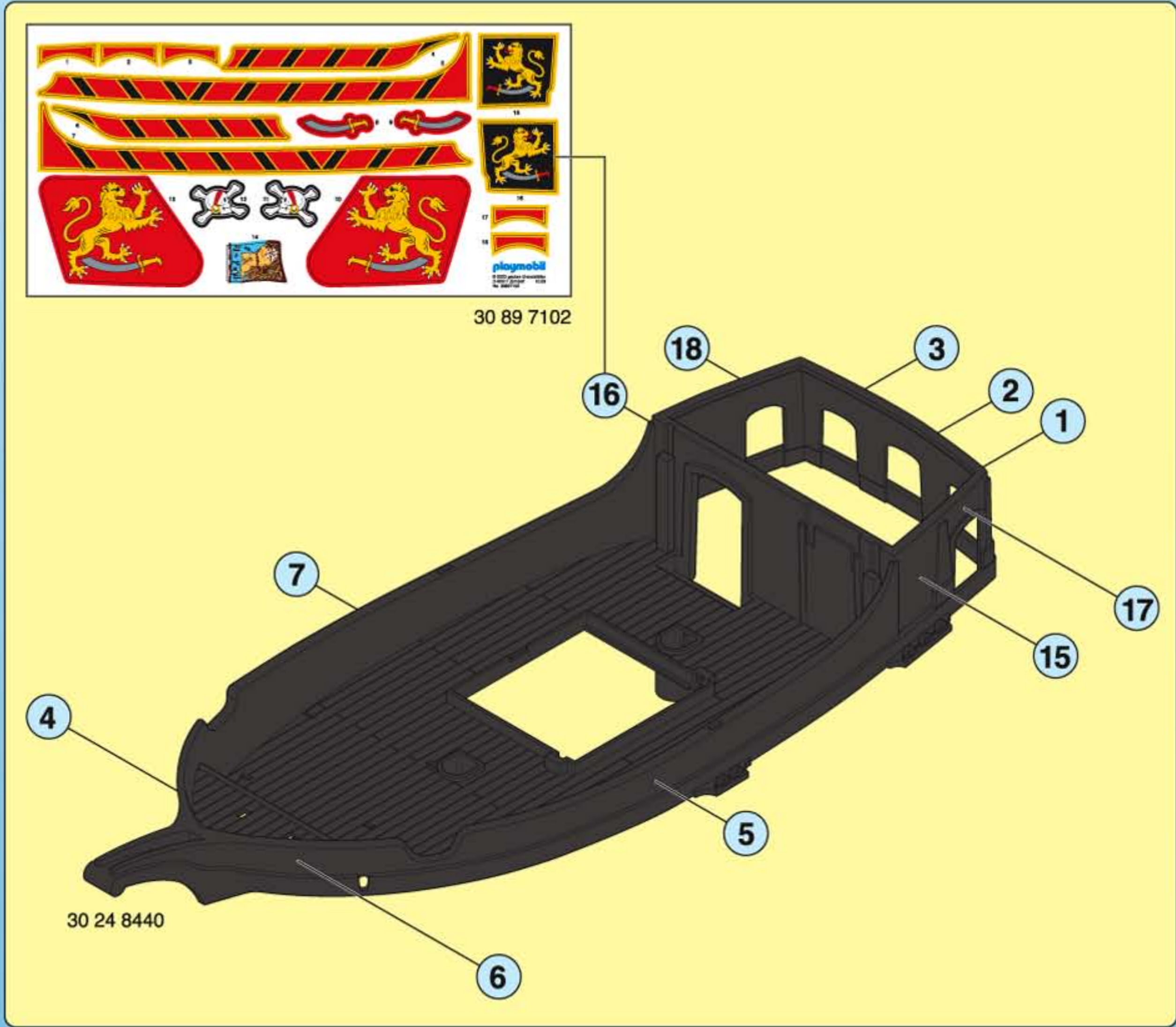

4

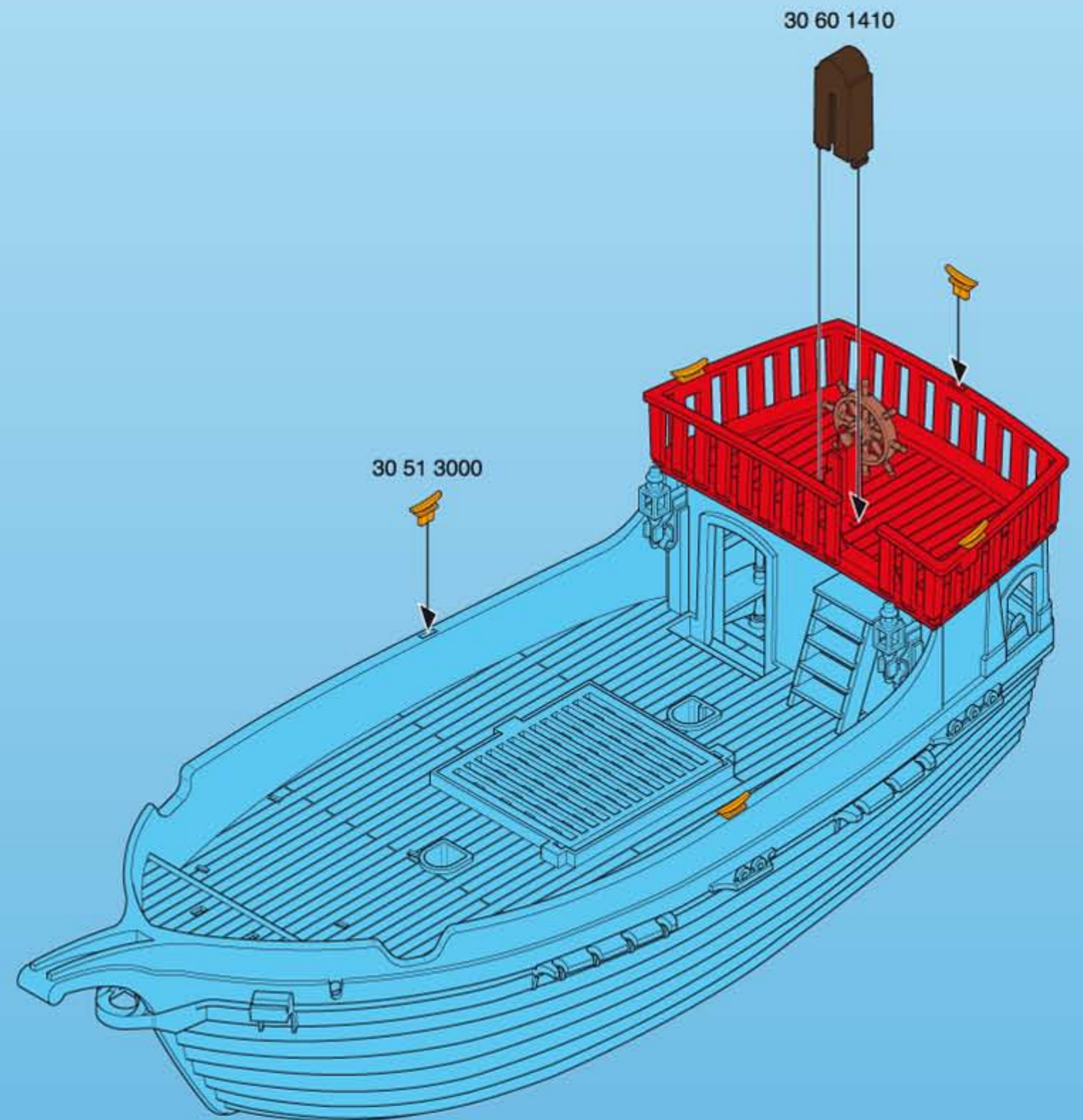
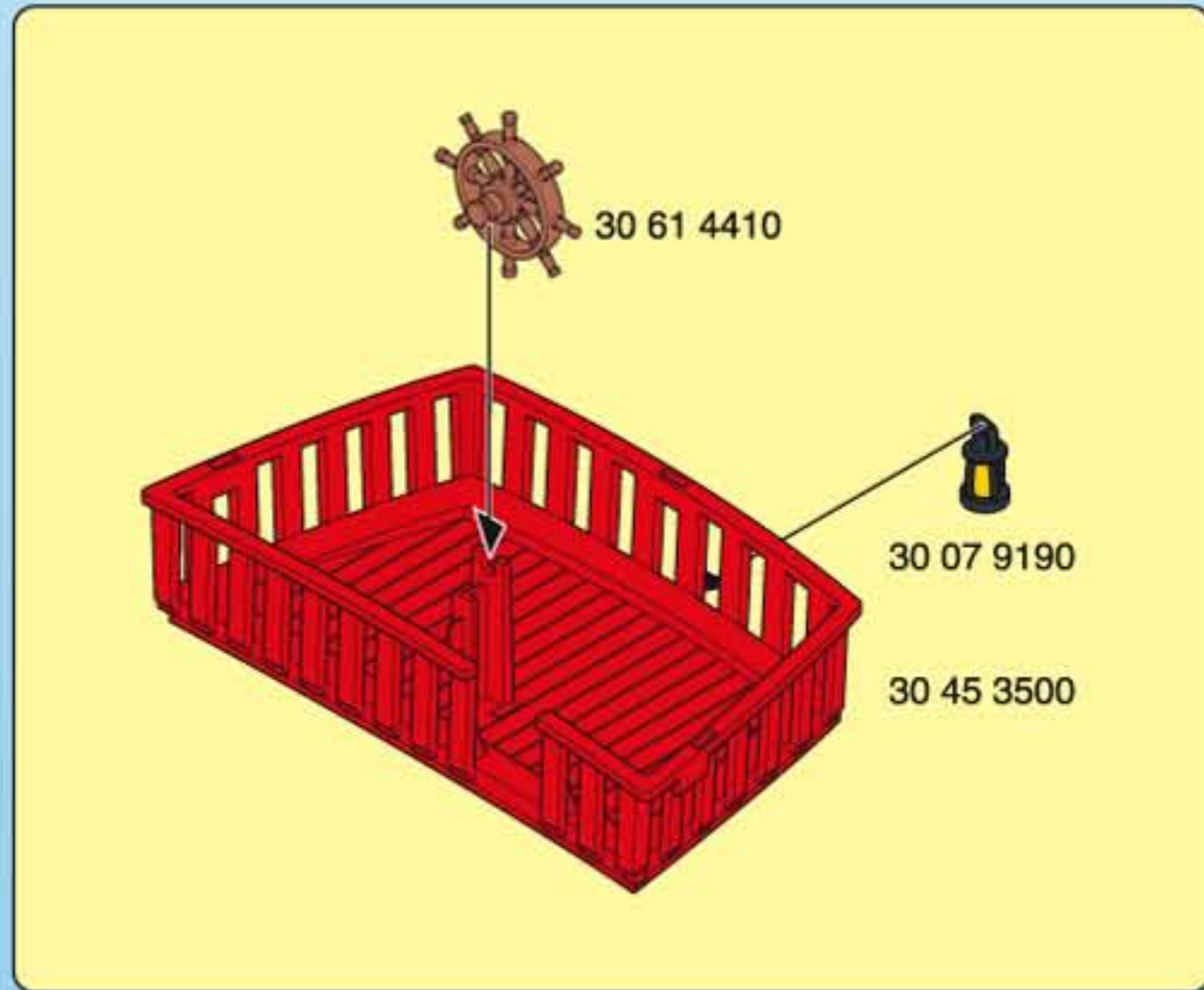

5

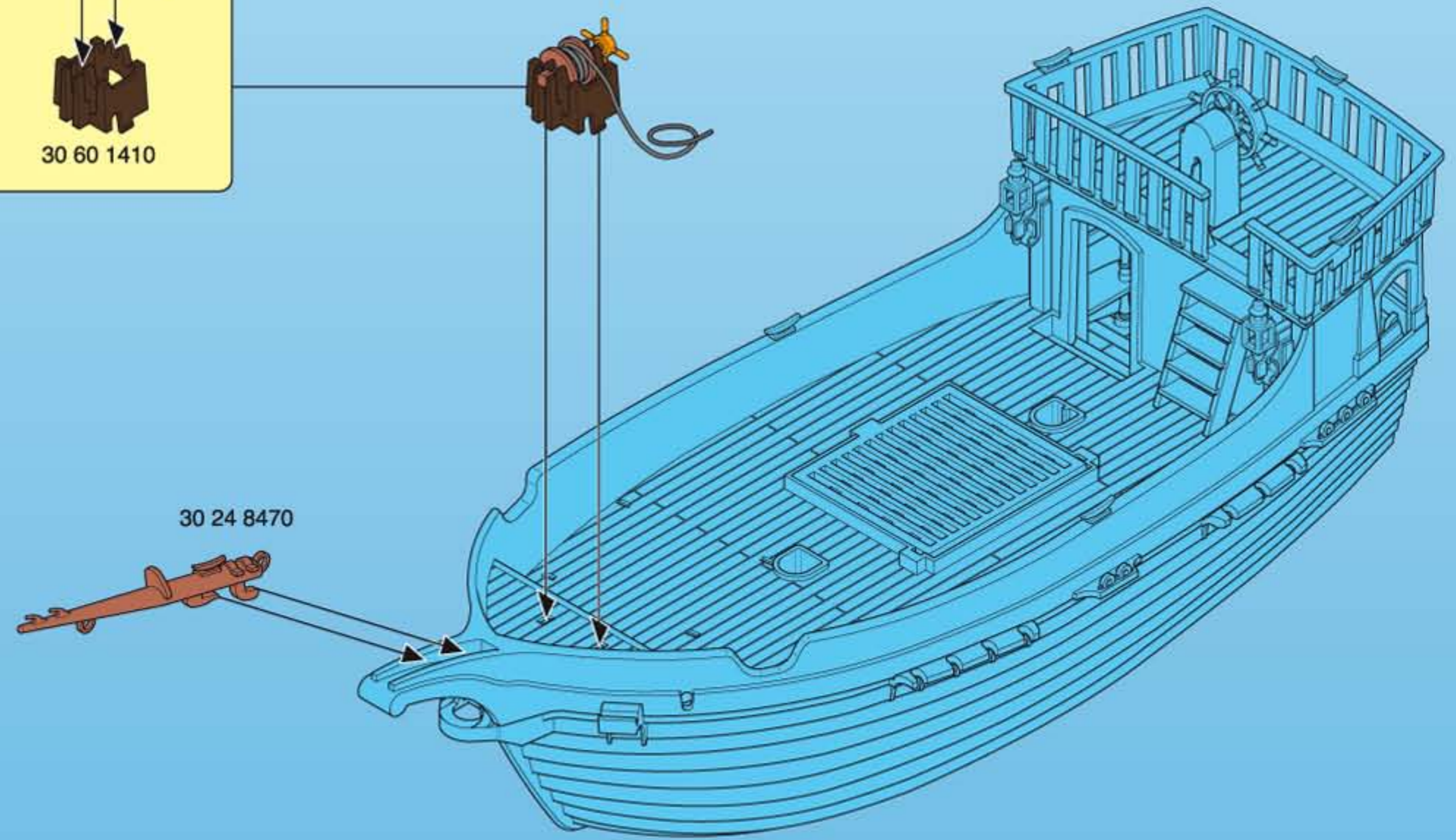
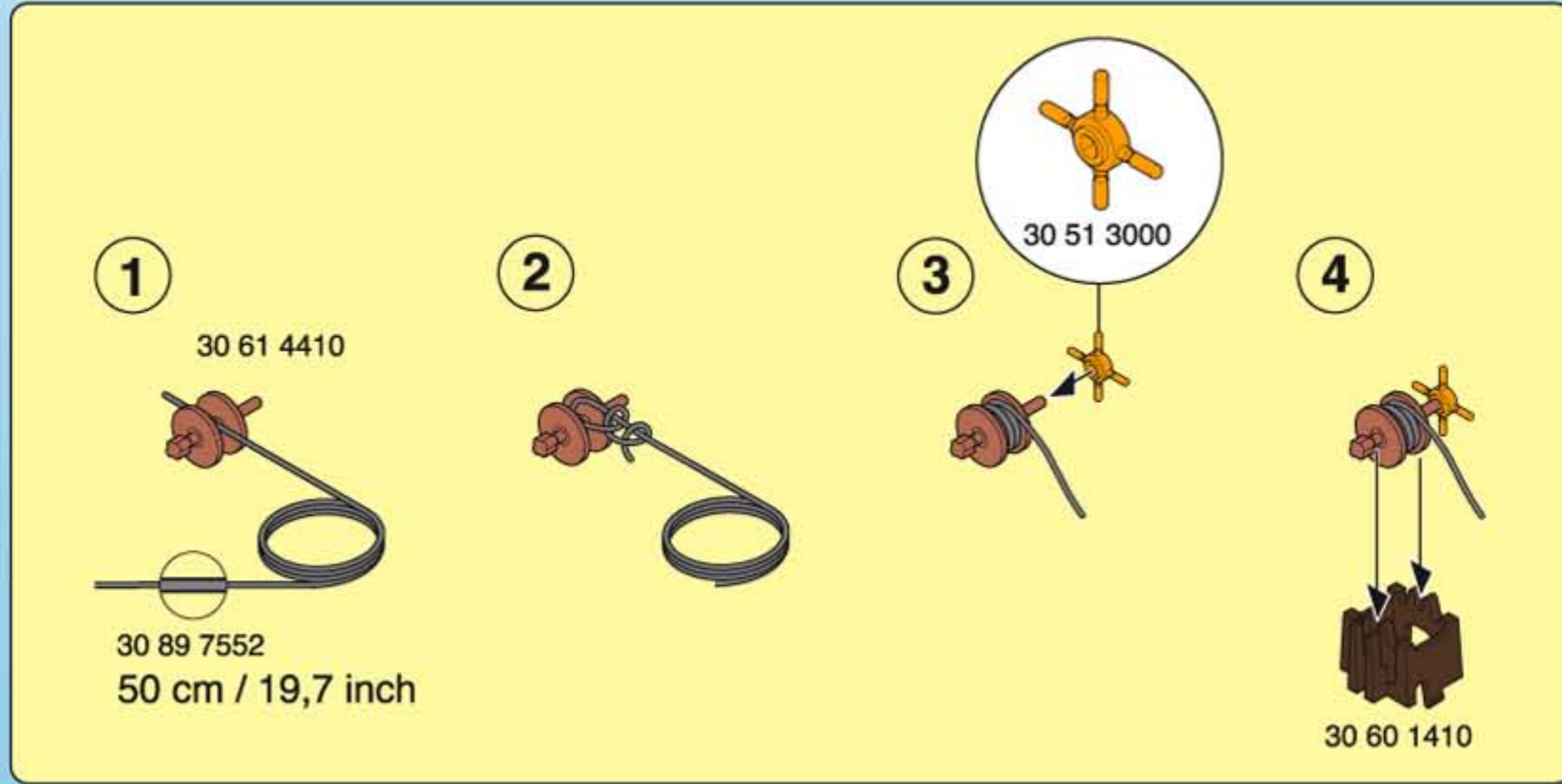

6

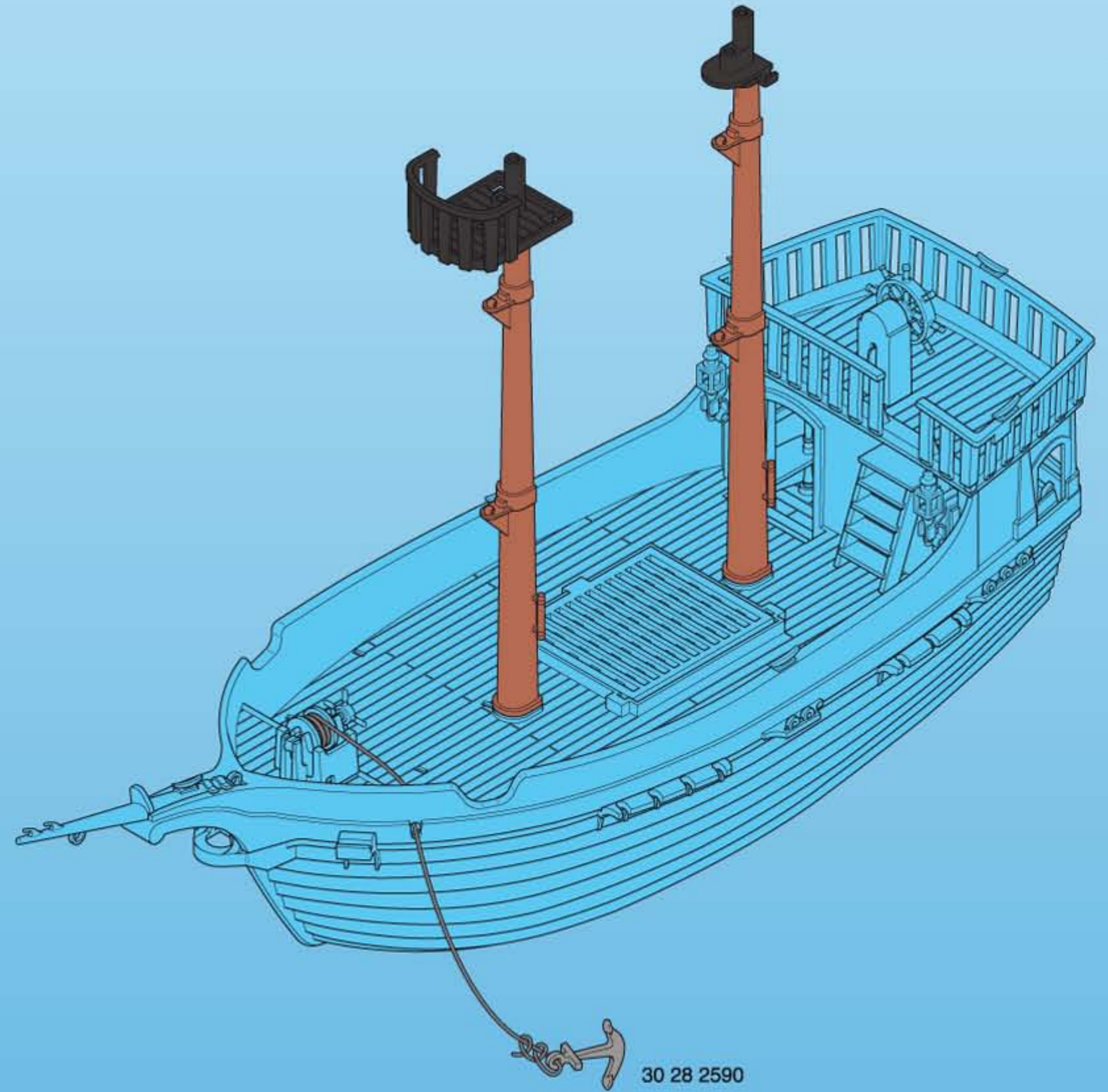
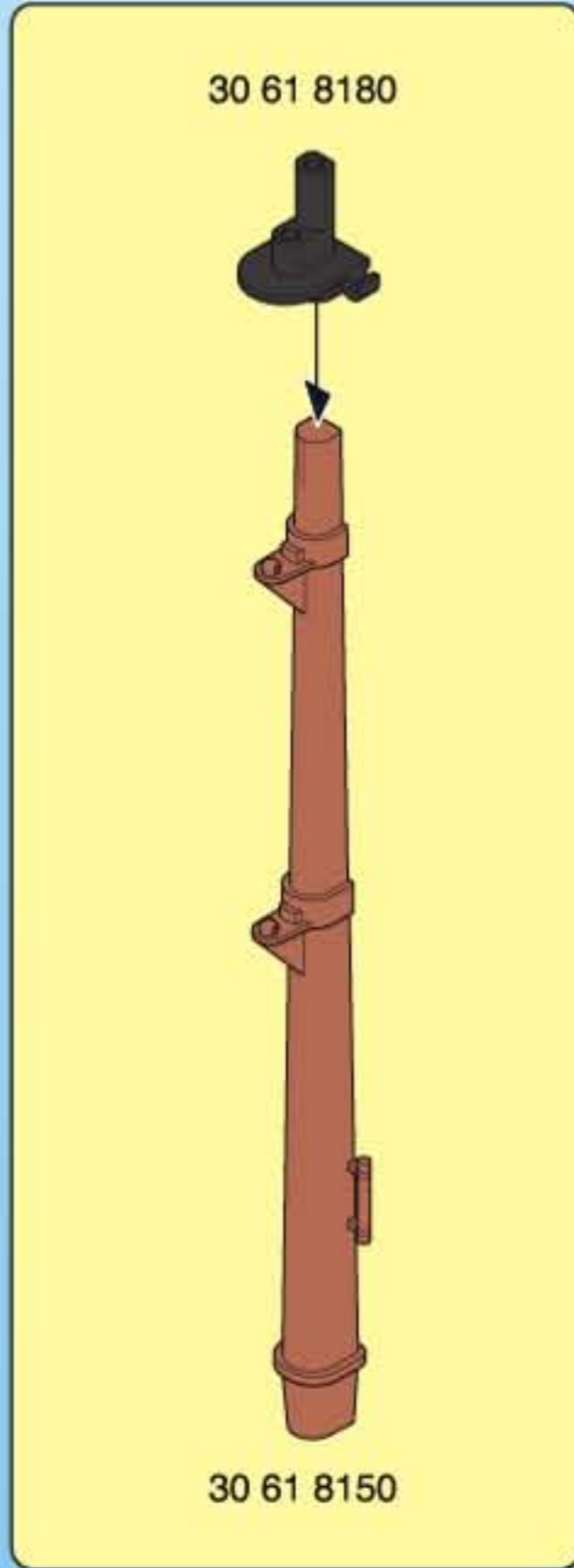
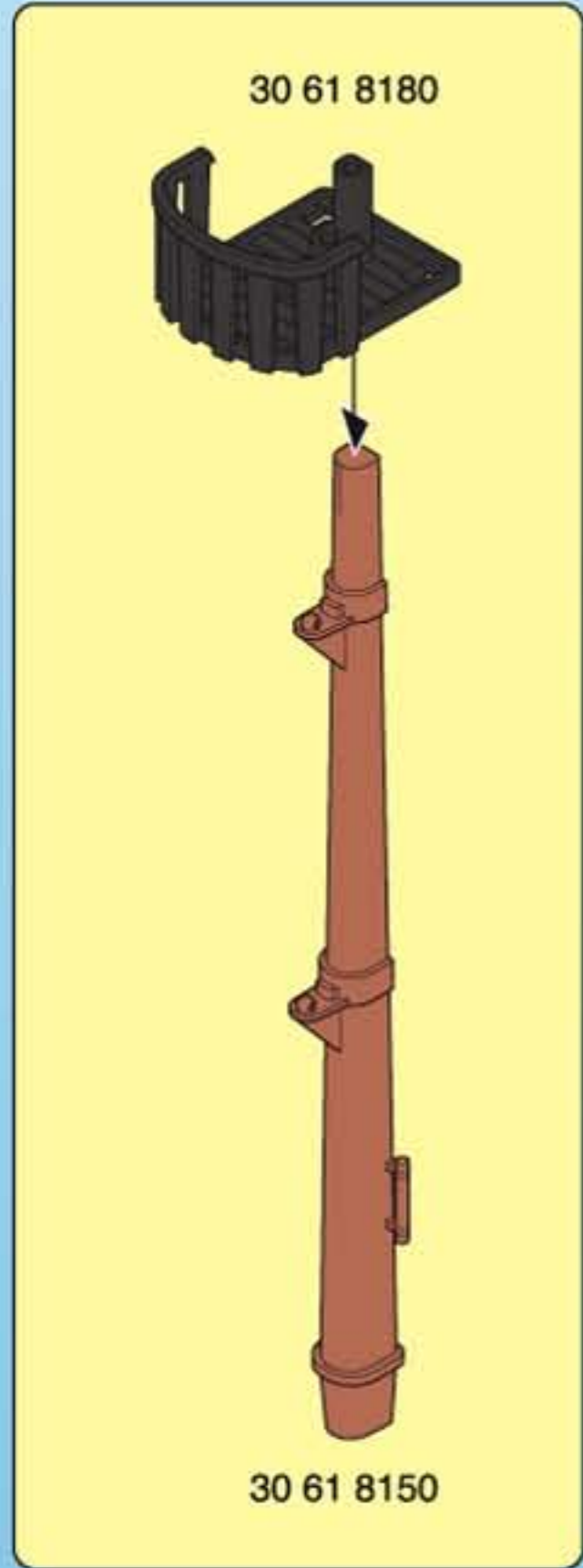

7

11 30 09 5230

12

30 21 8870

playmobil

8 30 03 1280

9

30 21 8870

playmobil

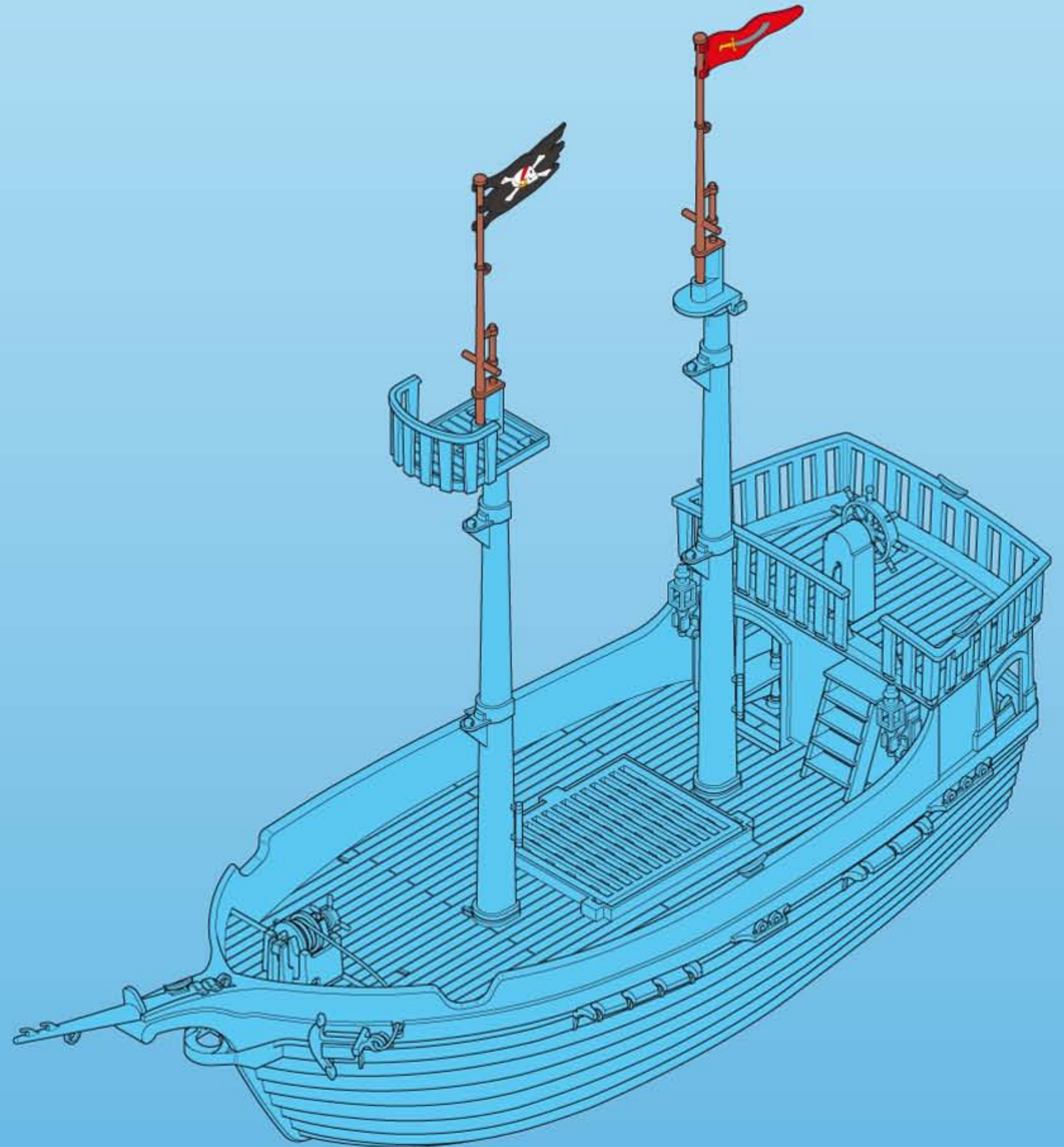

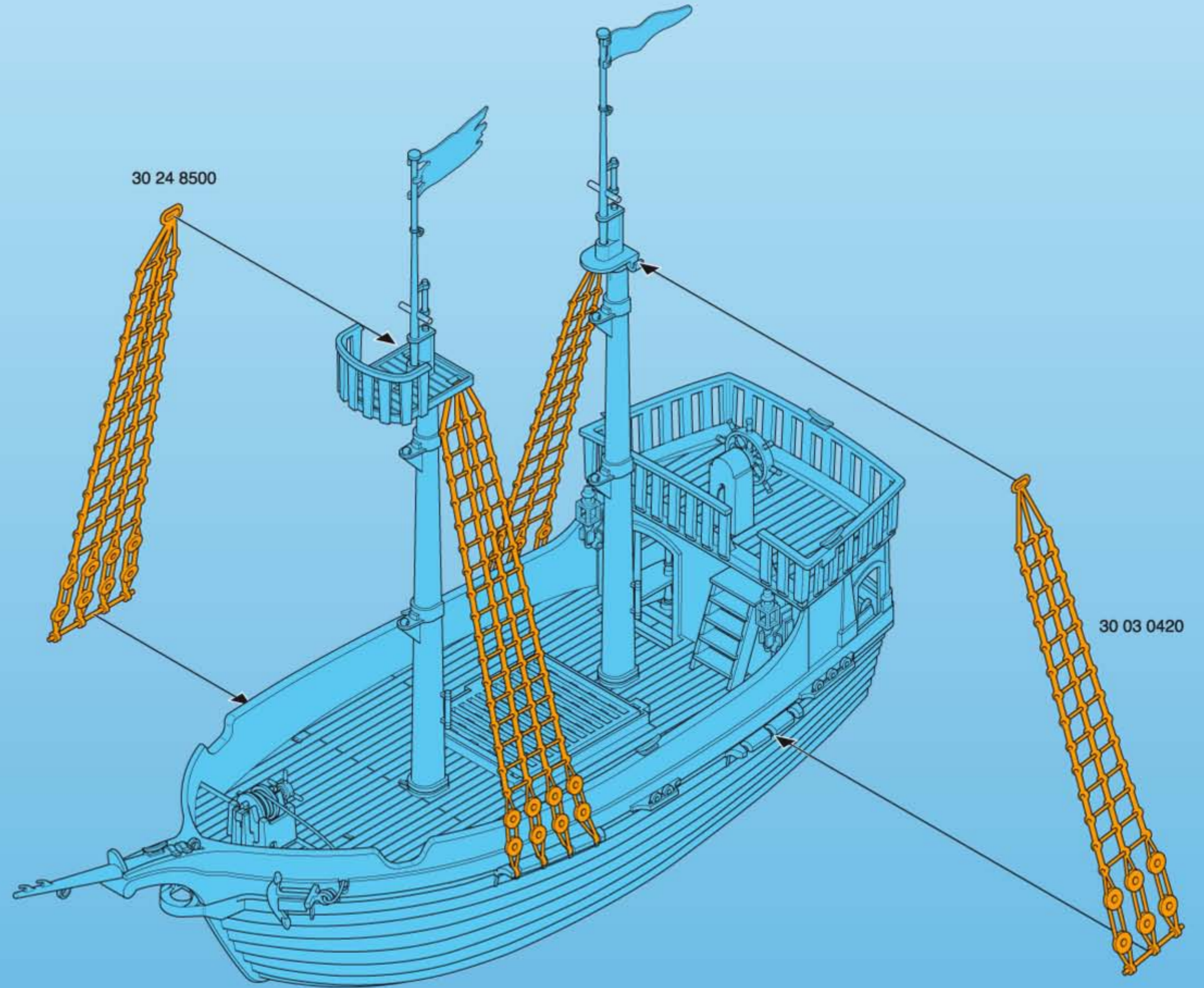

9

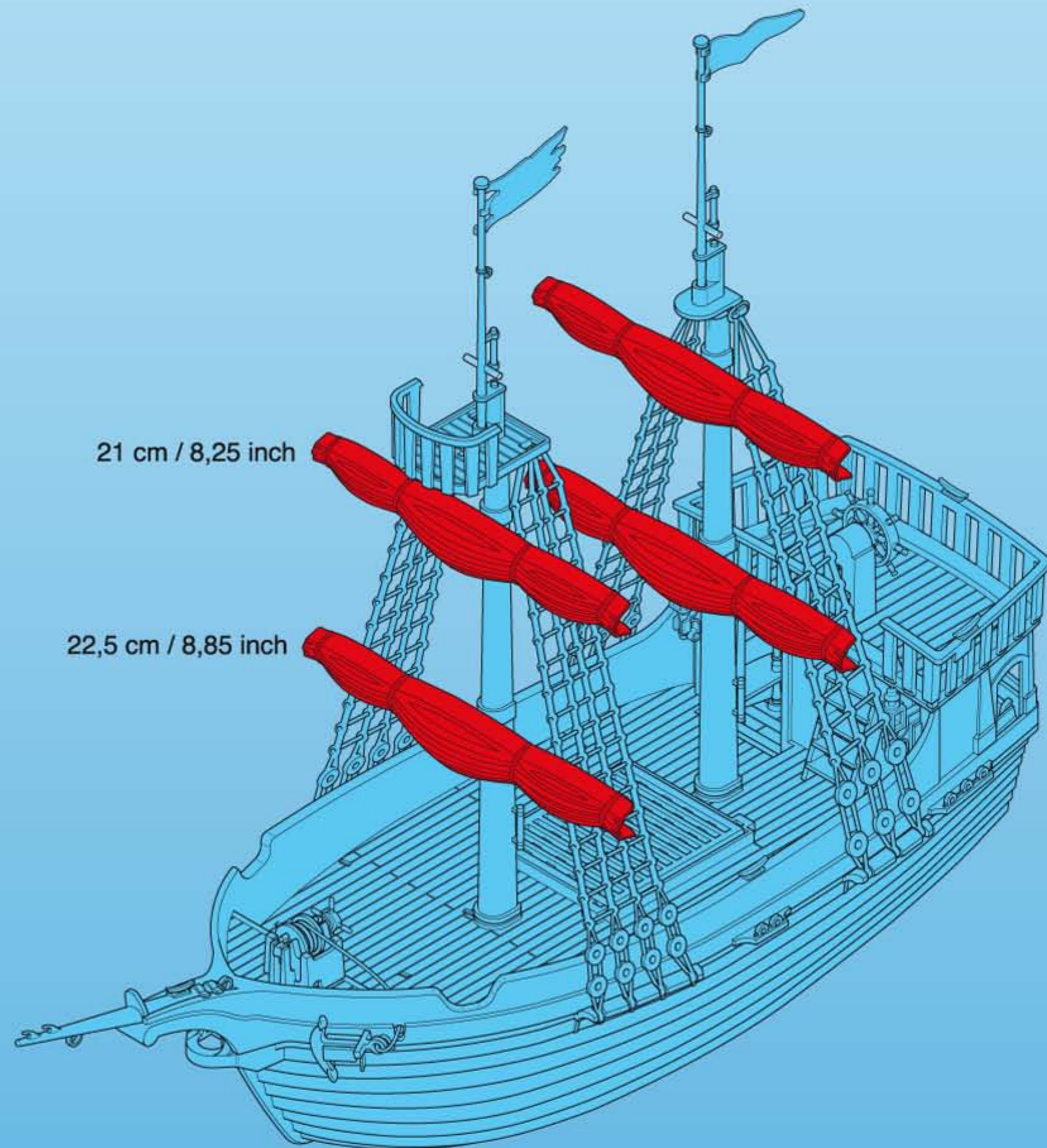
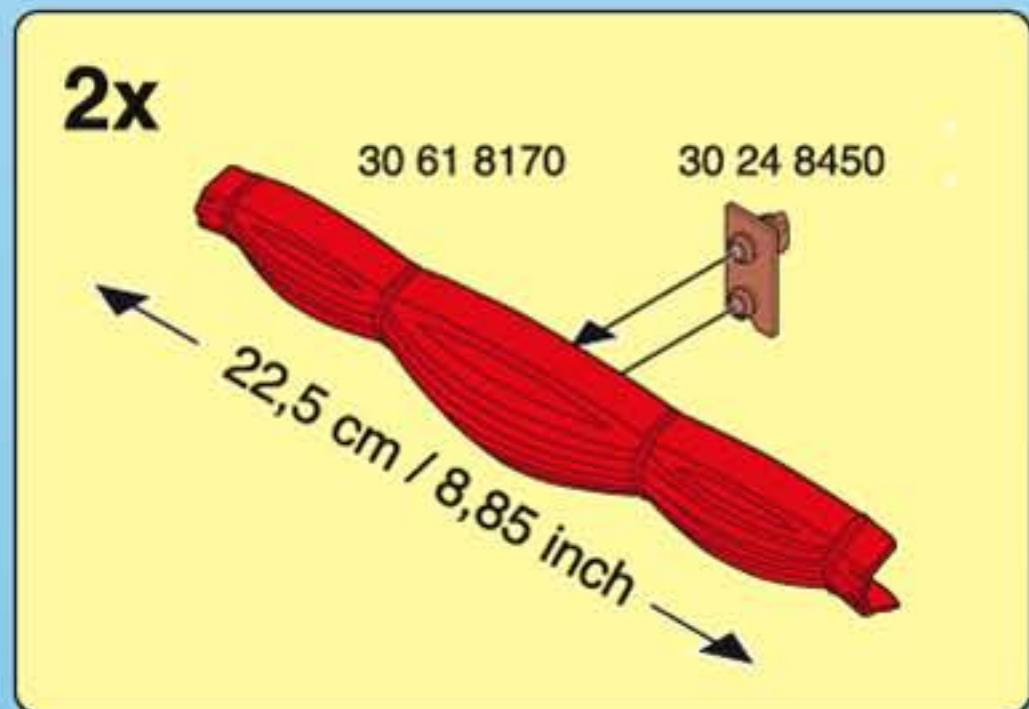
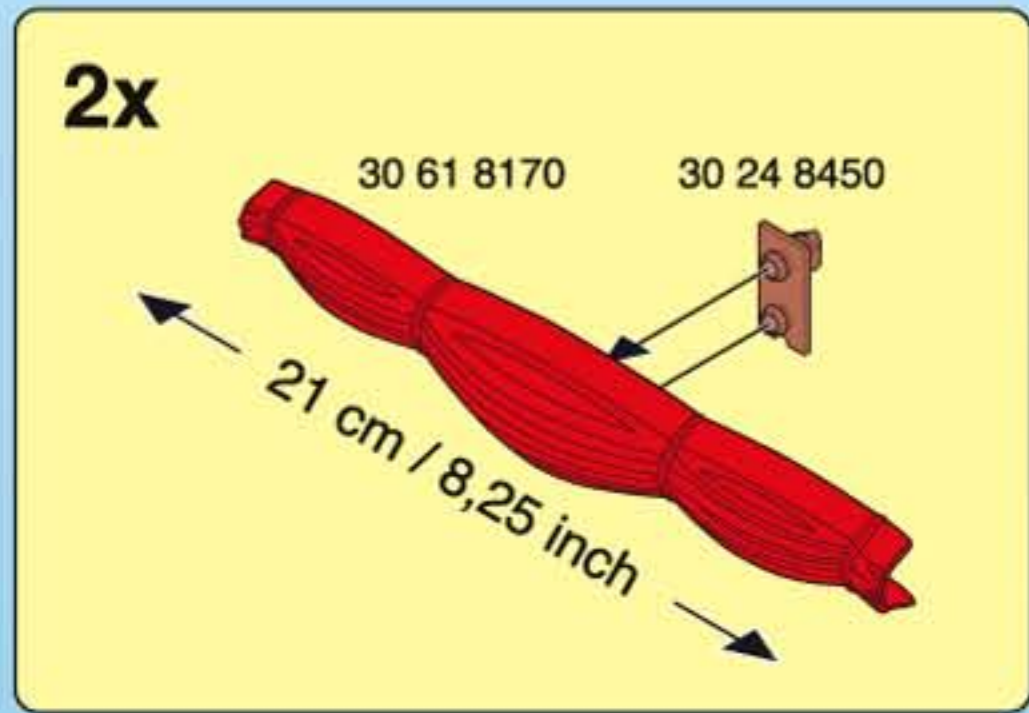

30 51 3000

13

30 24 8460

10

30 51 3000

playmobil

The diagram shows a parts list at the top with various components labeled 1 through 18. Below the parts list is an assembly diagram for step 10. It shows a red sail (part 10) being attached to a mast (part 13) using a wooden peg (part 30 51 3000). The sail is also secured to the deck with another wooden peg (part 30 51 3000). A part number 30 24 8460 is also indicated near the sail's attachment point.

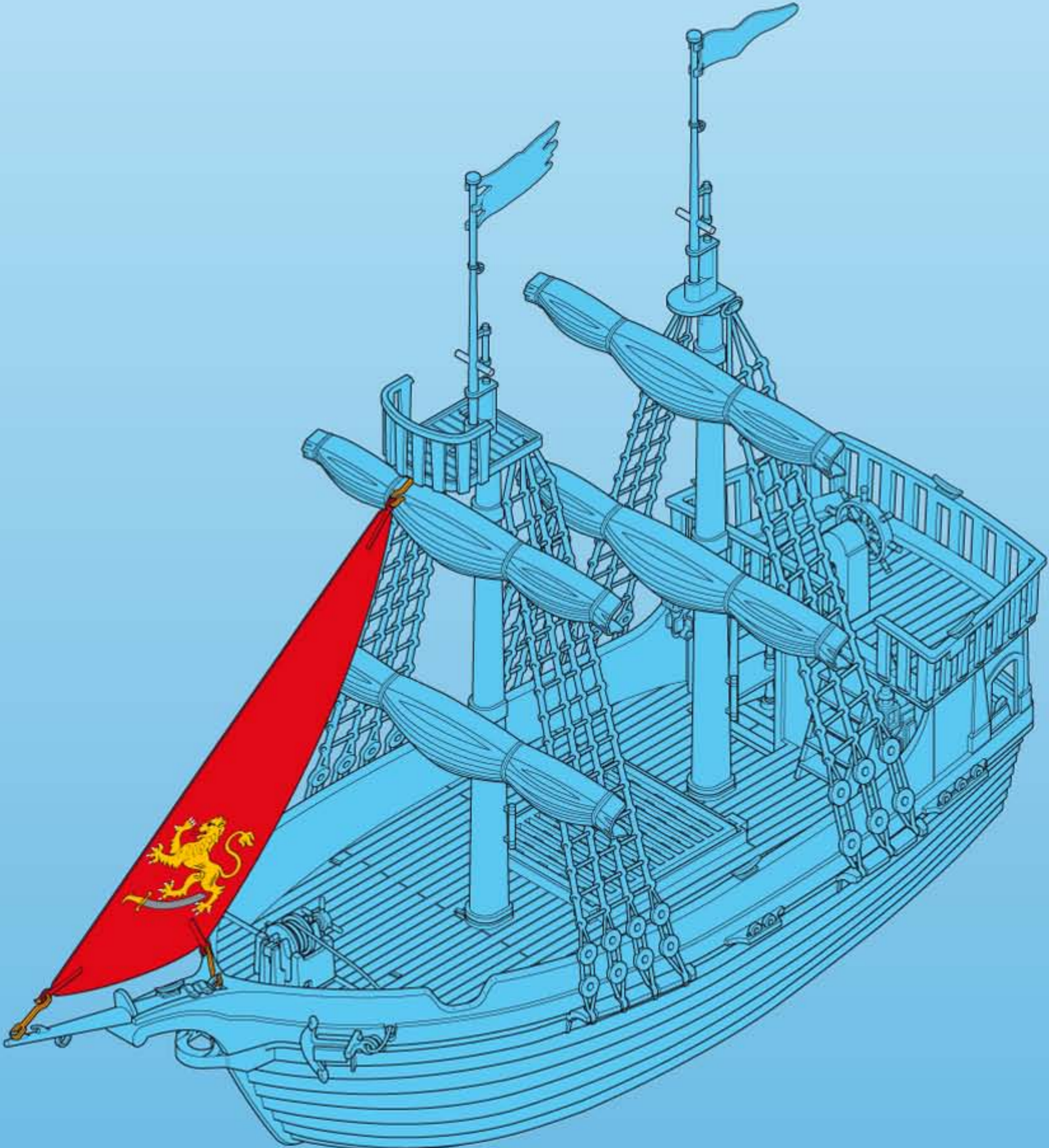

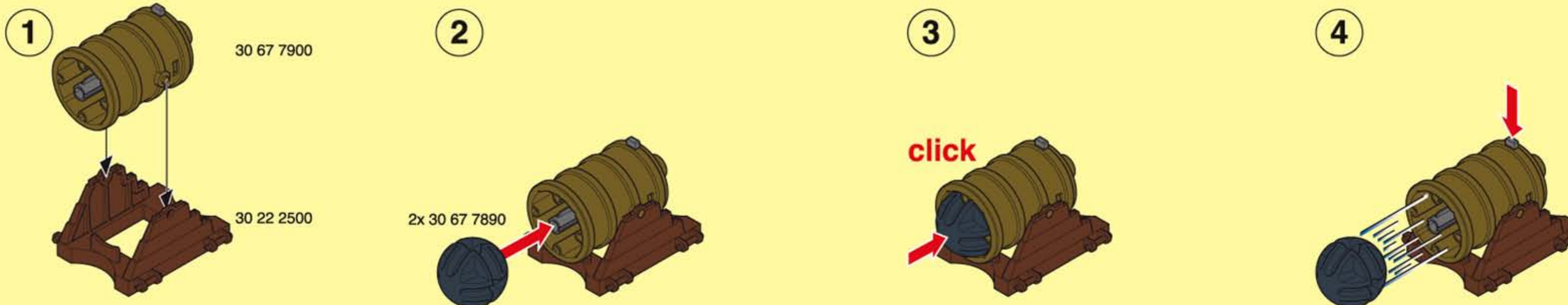

D A CH L B **ACHTUNG!** Nur mitgelieferte PLAYMOBIL Geschosse verwenden. Nicht auf Augen oder Gesicht zielen.

USA GB CDN M IRL **WARNING!** Only use the PLAYMOBIL projectiles supplied. Do not aim at eyes or face.

F CDN B L CH **ATTENTION!** Seulement utiliser les projectiles PLAYMOBIL fournis. Ne pas viser les yeux ou le visage

E MEX **ADVERTENCIA!** Utiliza únicamente los proyectiles PLAYMOBIL suministrados. No se ha de apuntar a los ojos ni a la cara.

NL B **WAARSCHUWING!** Uitsluitend meegeleverde PLAYMOBIL delen gebruiken. Niet op ogen of gezicht richten.

I CH **ATTENZIONE!** Usare soltanto i proiettili PLAYMOBIL in dotazione. Non mirare agli occhi o al viso.

P **AVISO!** Usar apenas os projécteis PLAYMOBIL juntamente fornecidos. Não apontar para os olhos ou face.

DK **ADVARSEL!** Anvend kun de medfølgende PLAYMOBIL projektiler. Sigt ikke mod øjne eller ansigt.

N **ADVARSEL!** Benytt kun PLAYMOBIL prosjektil som leveres med. Sikt ikke på ansikt eller øyne.

S FIN **VARNING!** Använd endast medlevererade PLAYMOBIL-skott. Sikta ej mot ögonen eller ansiktet.

FIN **VAROITUS!** Käytä vain mukana toimitettuja PLAYMOBIL-ammuksia. Älä tähtää päin silmiä tai kasvoja.

H **FIGYELEM!** Csak a csomagban található PLAYMOBIL lövedékeket szabad használni. Óvd a szemeidet és az arcod!

CZ **VAROVÁNÍ!** Používejte pouze střely PLAYMOBIL, které jsou součástí dodávky. Nemiřte na oči nebo na obličej!

EST **HOIATUS!** Kasutage ainult kaasaantud PLAYMOBIL'i laskemoona. Ära sihi silmadesse ega näkku.

LV **BRĪDINĀJUMS!** Izmantot tikai PLAYMOBIL piegādes komplektā iekļautos šāviņus. Nevērst pret acīm vai seju.

LT **DĖMESIO!** Naudokite tik pridėdamus PLAYMOBIL šaudmenis. Netaikyti į akis arba veidą.

SLO **OPOZORILO!** Uporabljajte le priložene PLAYMOBIL-ove krogle. Ne merite v oči ali obraz.

SK **UPOZORNENIE!** Používajte len náboje dodávané spolu so sadou PLAYMOBIL. Nemieriť do očí alebo do tváre.

PL **UWAGA!** Stosować tylko załączone PLAYMOBIL - kule / pociski. Nie celować w oczy i twarz.

TR CY **UYARI!** Sadece birlikte verilen PLAYMOBIL mermileri kullanınız. Göze veya yüze doğru tutmayınız.

GR CY **ΠΡΟΣΟΧΗ!** Να χρησιμοποιούνται αποκλειστικά τα βλήματα της PLAYMOBIL που περιέχονται στη συσκευασία. Μη σκοπεύετε τα μάτια ή το πρόσωπο.

RO **AVERTIZARE!** Se folosesc doar proiectilele incluse PLAYMOBIL. Nu se țintește în ochi sau în față.

BG **ПРЕДУПРЕЖДЕНИЕ!** Използвайте само приложени PLAYMOBIL снаряди. Не насочвайте към очите и лицето.

CN **警告!** 仅能用PLAYMOBIL的炮弹。禁止瞄准眼睛或脸。请勿瞄准眼睛或脸。

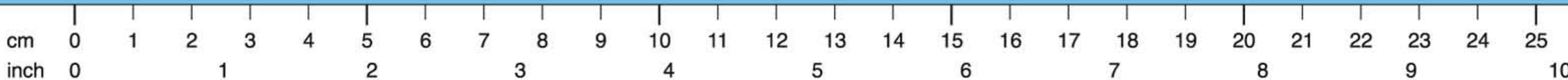
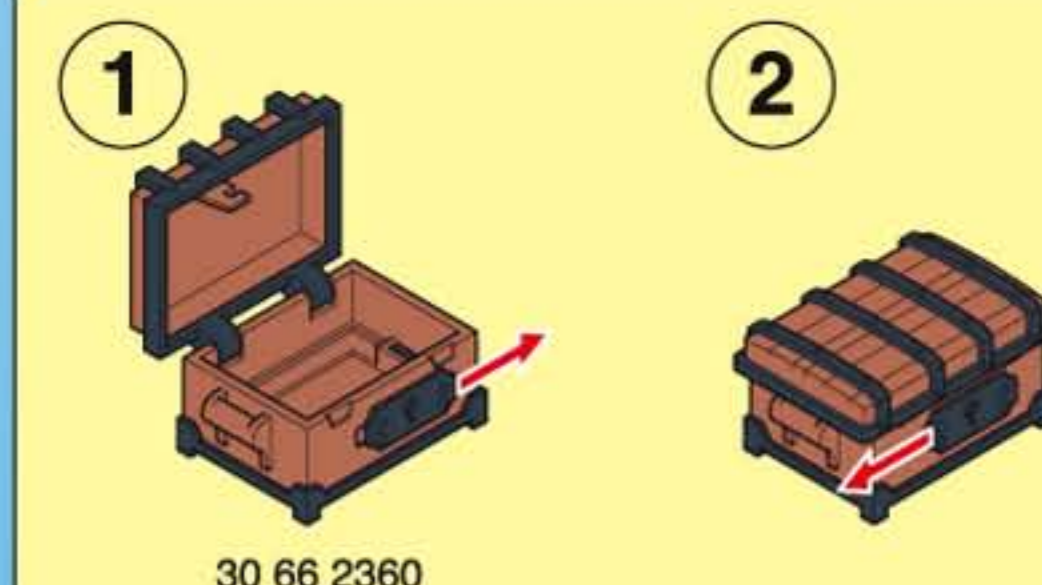
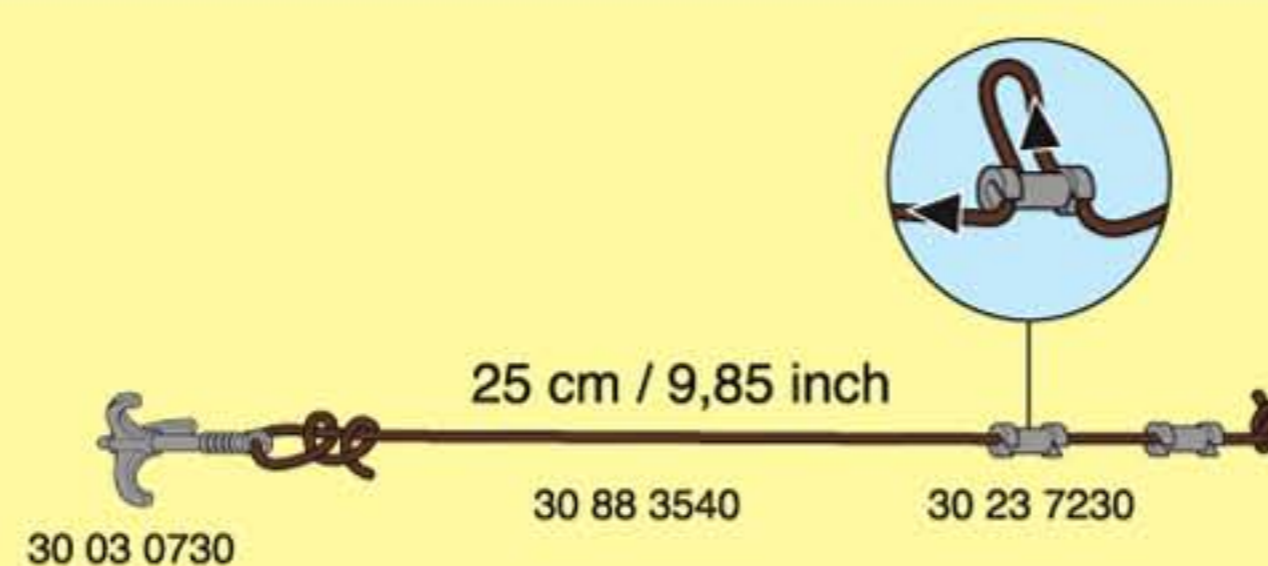
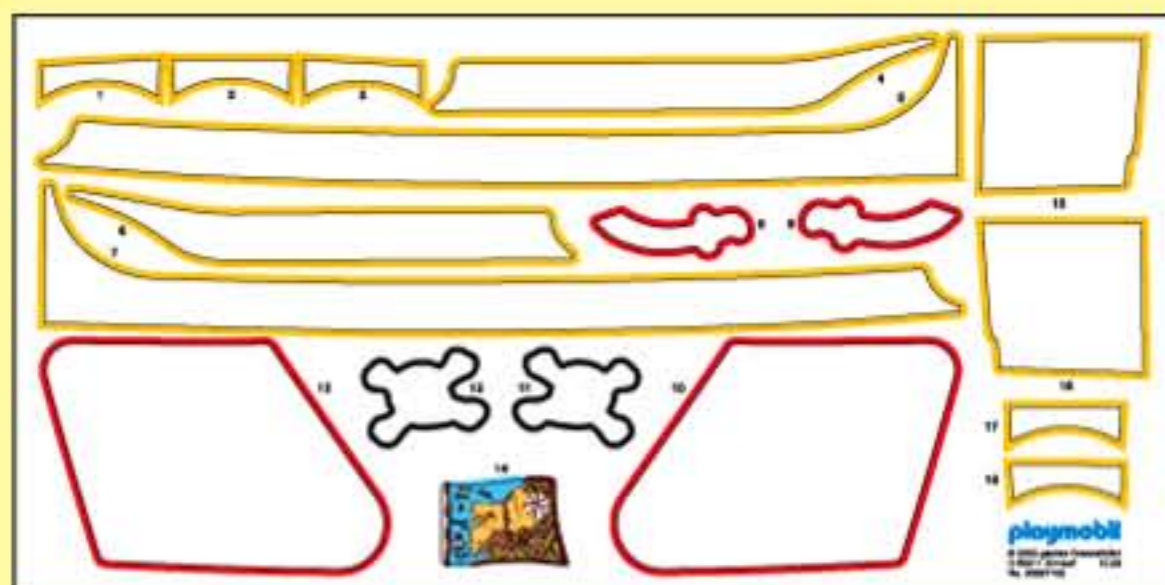

30 20 4780



30 62 5990

30 21 9000



30 62 6060

30 63 6640



2x 30 21 9010



30 04 7250



30 13 0640

30 05 5770



30 05 2370



30 06 2160

30 00 8400



30 00 8870

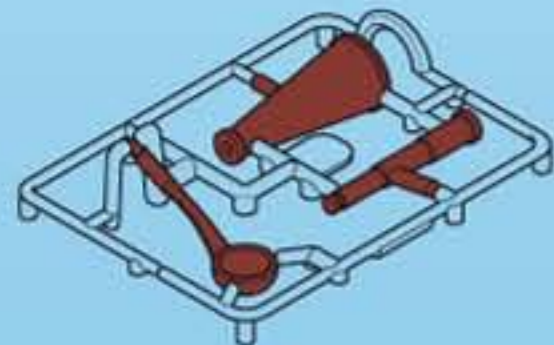

30 61 4440



30 61 8200



30 65 0220



30 83 0360



30 21 5510



30 21 1060



2x 30 06 3690



2x 30 09 5440



2x 30 03 0890



30 06 3500



30 21 8520



30 65 9340



30 09 5650



30 21 0920

Serviceadressen finden Sie in allen Playmobil-Prospekten	In alle PLAYMOBIL catalogi vindt u het adres van onze klantendienst.
Addresses of Customer Service Departments are shown in all Playmobil catalogues	Las Direcciones de los Departamentos de Servicio al Consumidor se encuentran en todos los catálogos Playmobil
L'adresse du service consommateurs est indiquée dans tous les catalogues Playmobil	Η διεύθυνση του Γραφείου Εξυπηρέτησης Πελατών είναι καταχωρημένη σε όλους τους καταλόγους Playmobil
Troverete gli indirizzi dei centri di assistenza in tutti i cataloghi Playmobil	pronounce: plāy-mō-bēēl