

# playmobil®

## 5645

Wichtige Unterlagen, bitte sorgfältig aufbewahren !  
Important: Please keep these instructions for future reference !  
Documents importants, à conserver soigneusement !  
Belangrijke documenten, bewaar deze zorgvuldig !



### WARNING: CHOKING HAZARD

Small parts. Not for children under 3 years.

"Ne concerne que les USA"





1

30 64 2204



30 06 0920

30 27 7280

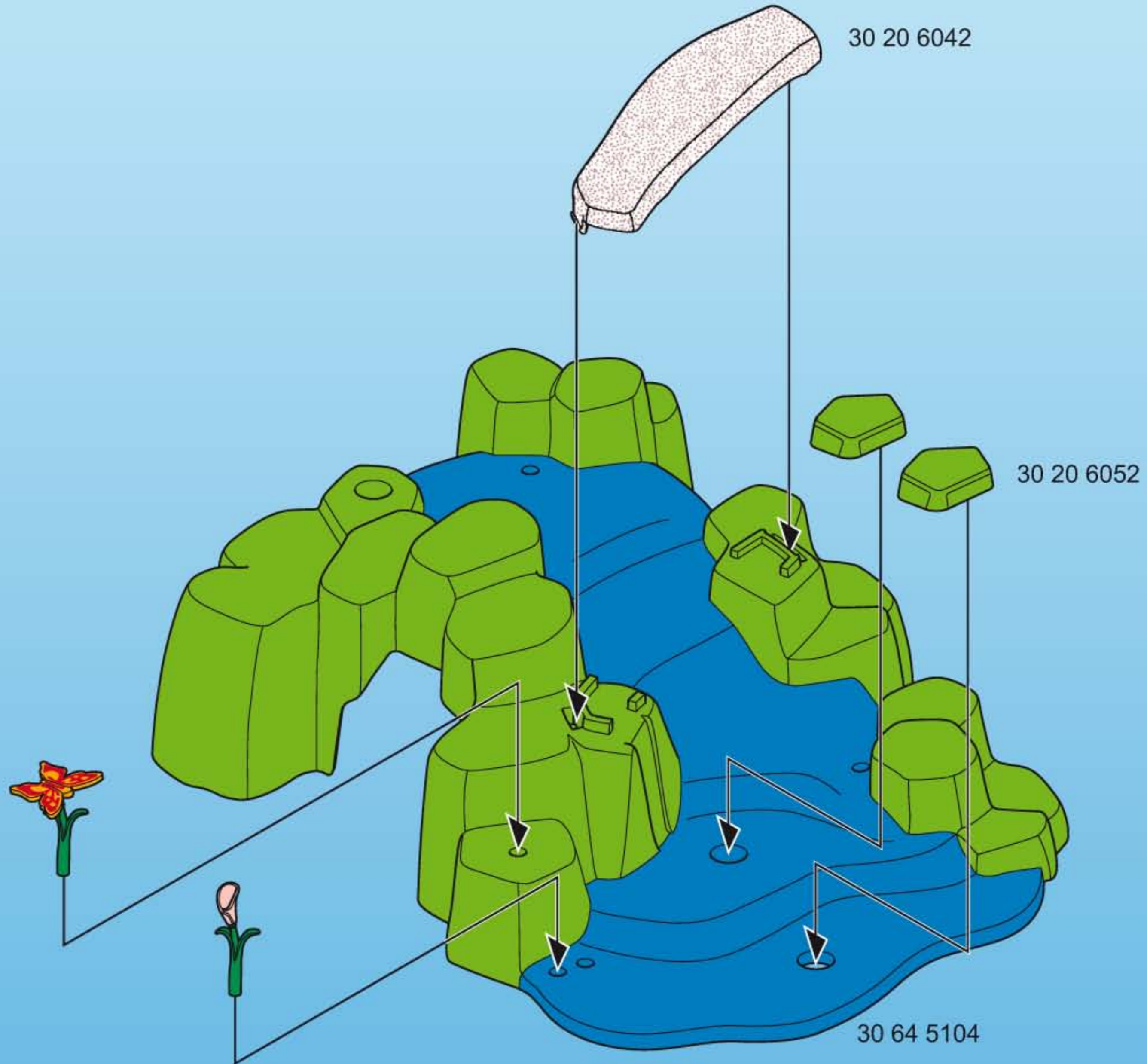



2

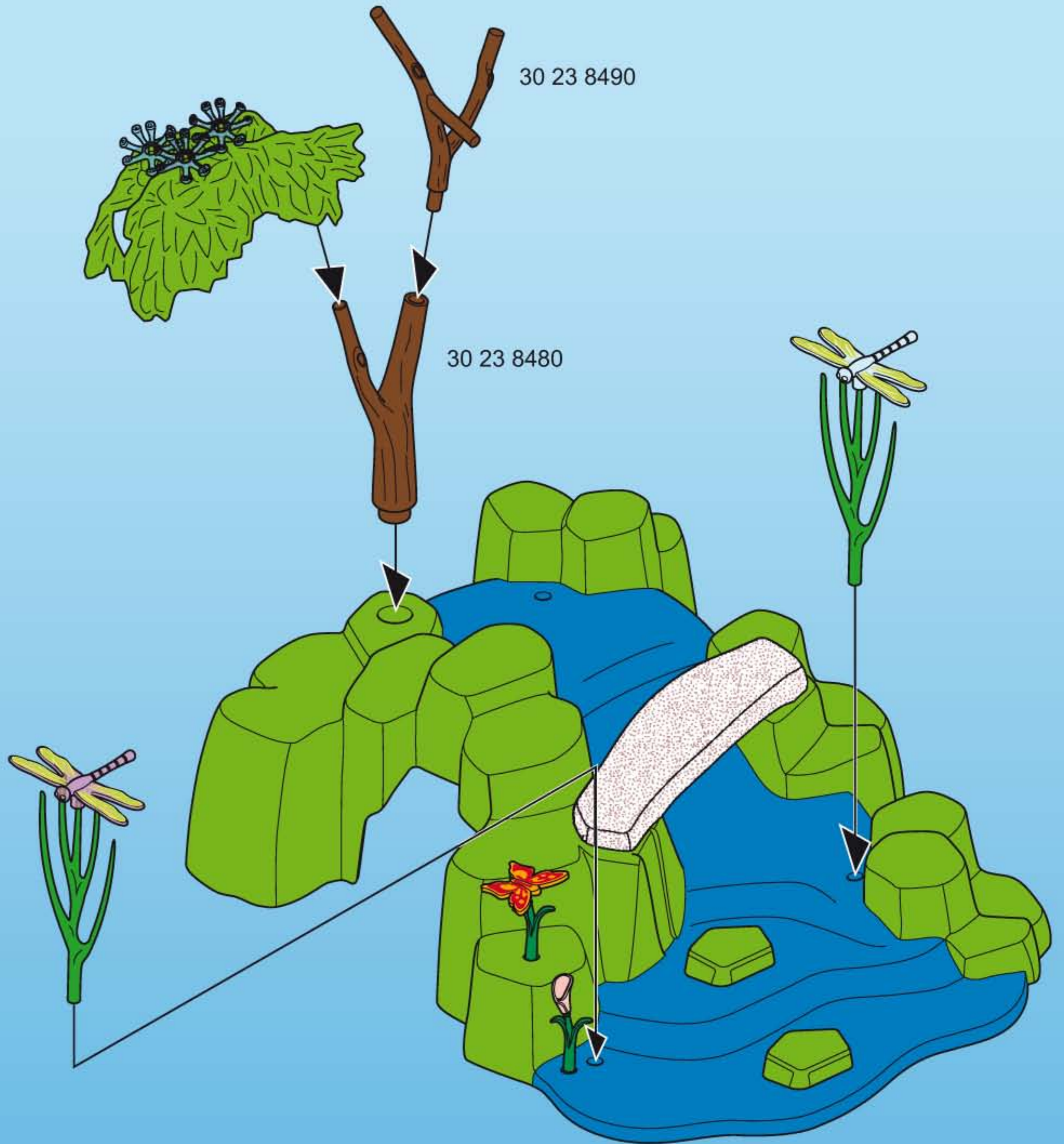
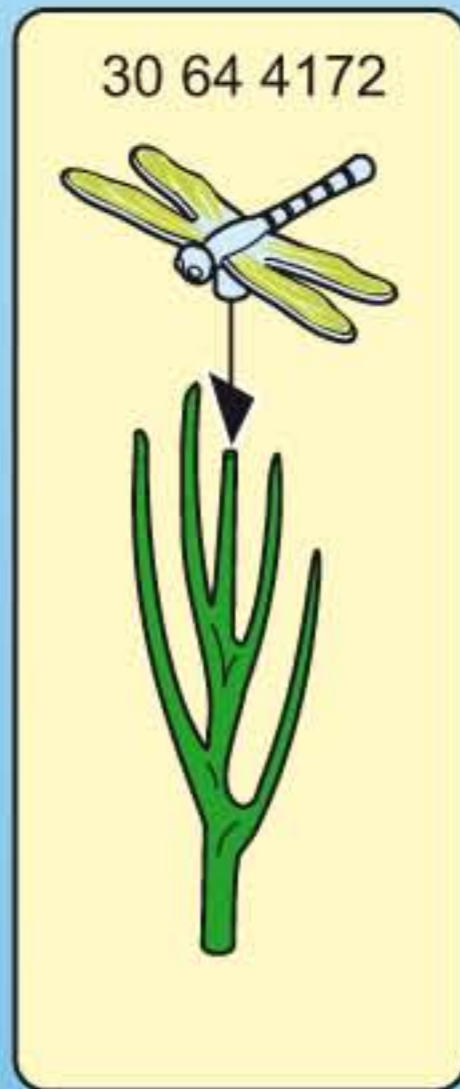
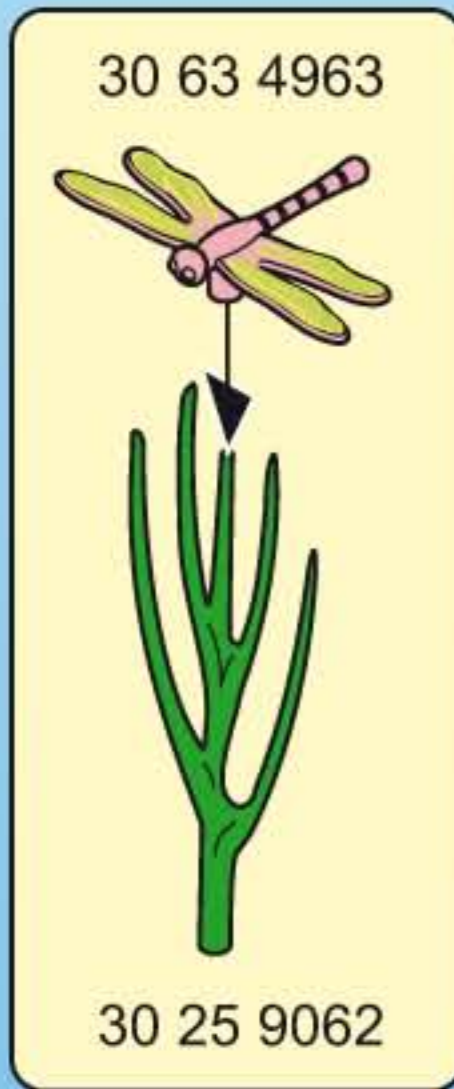
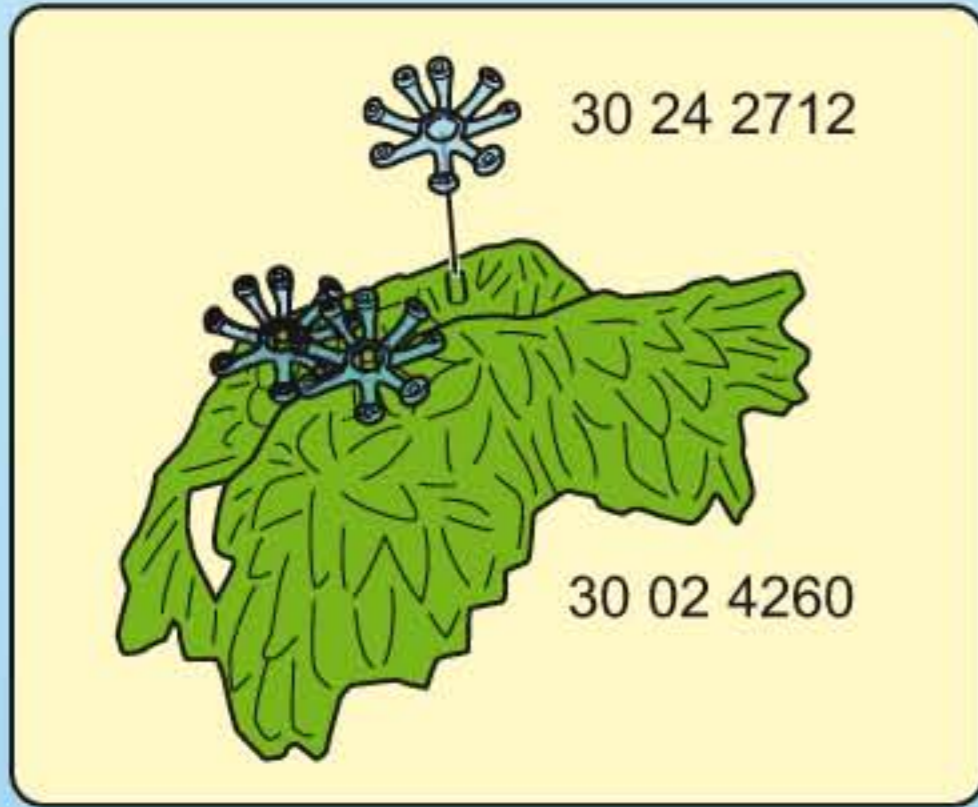



3

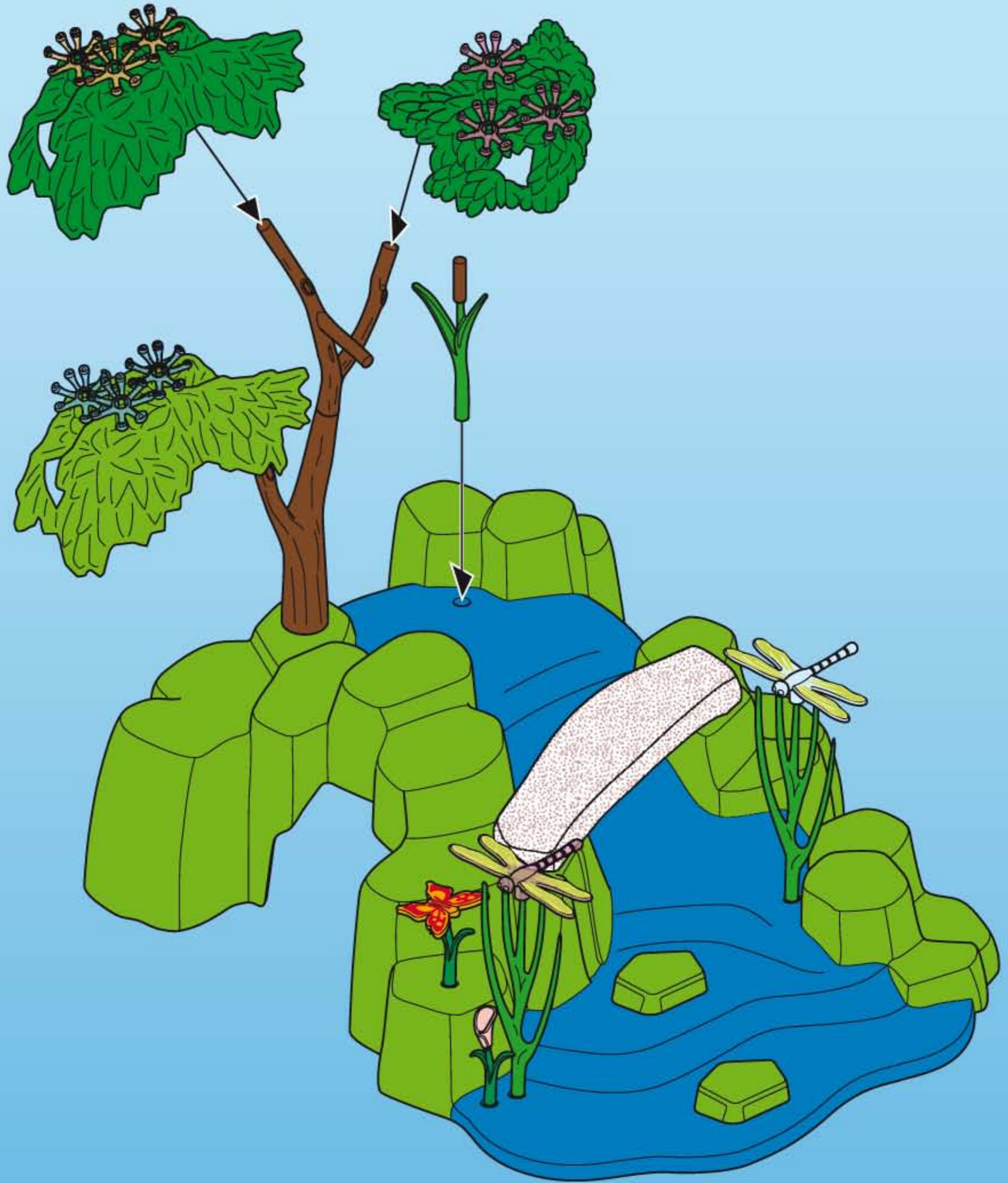
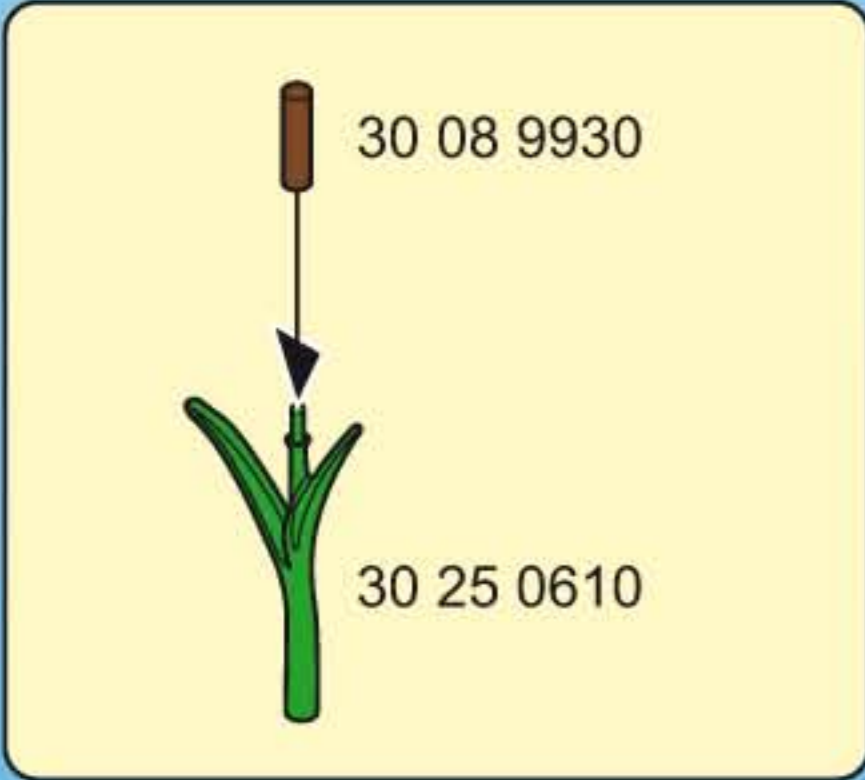
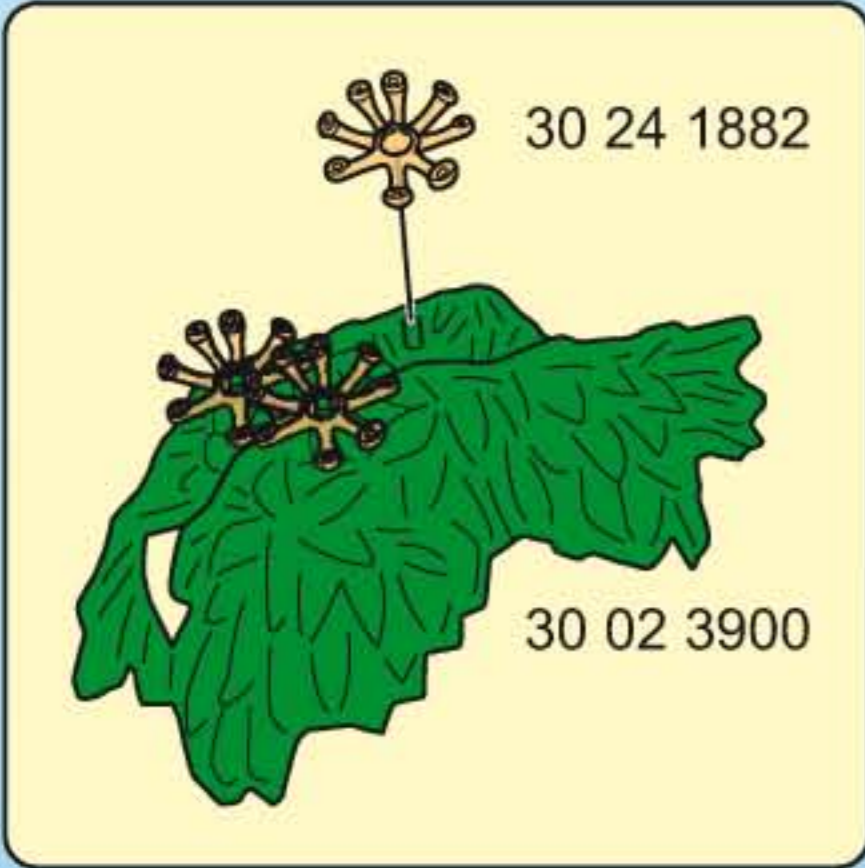



1

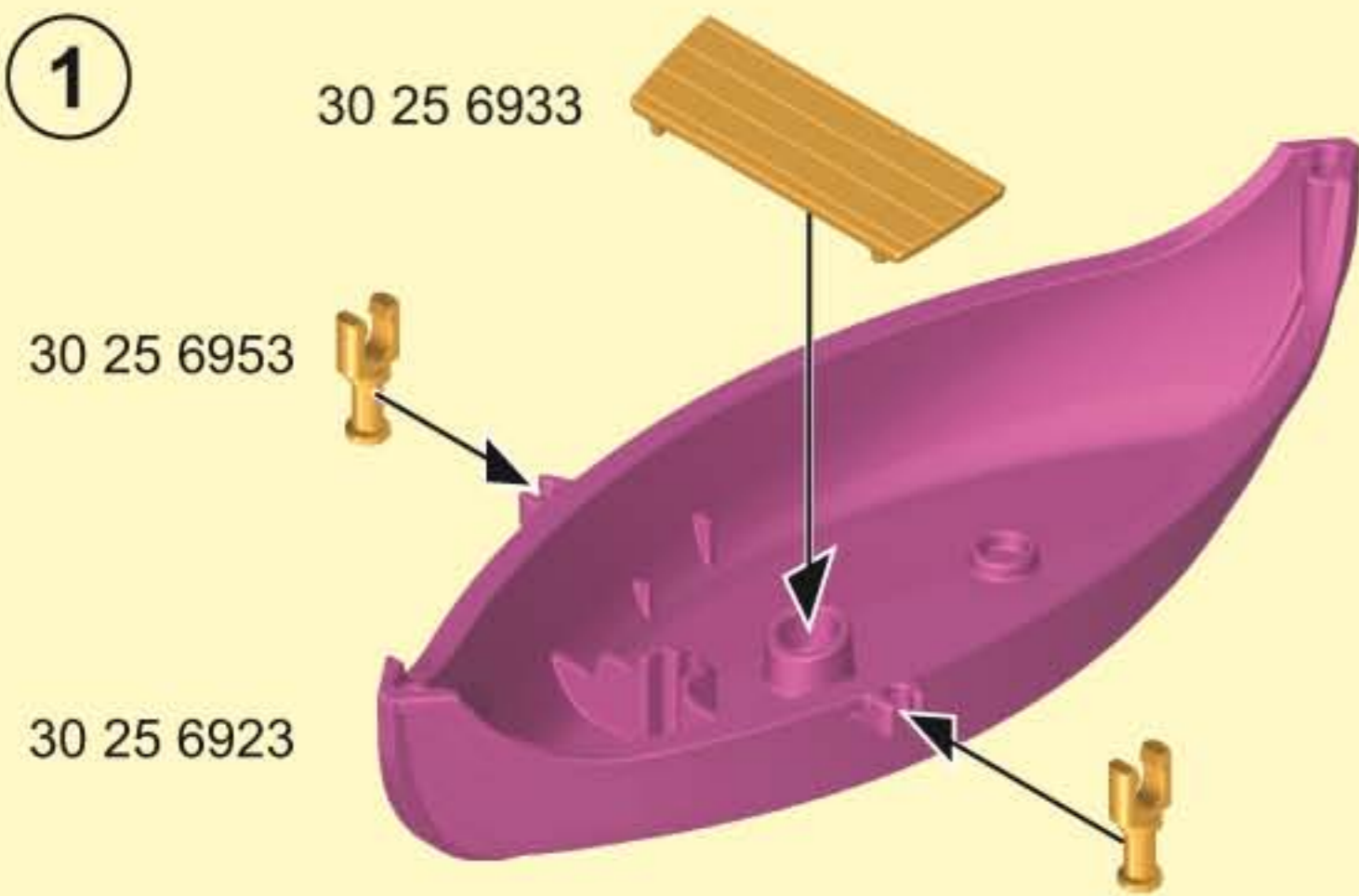

2

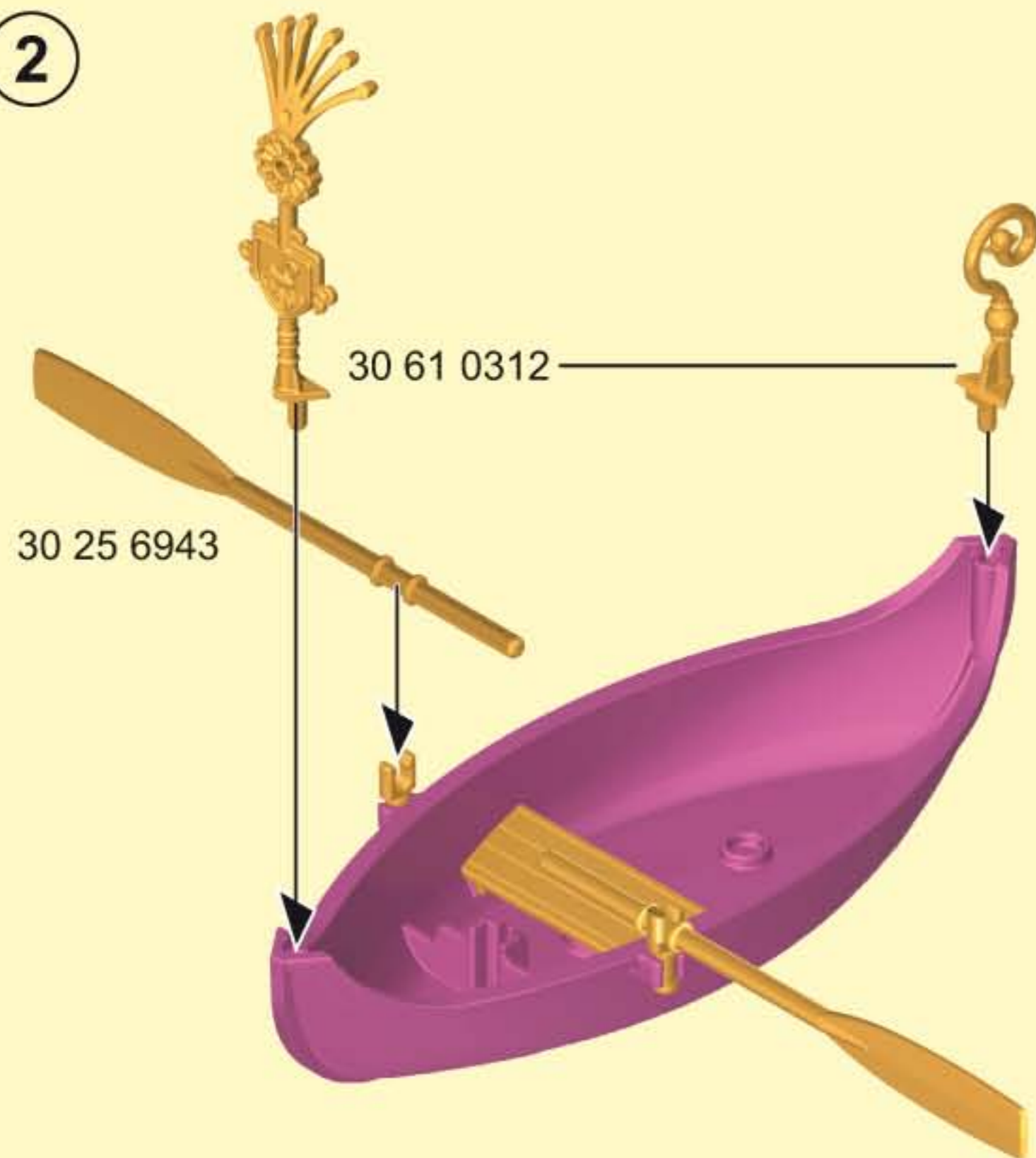

**(D) (A) (CH) (L) (B) ACHTUNG!**

Nur im flachen Wasser unter Aufsicht von Erwachsenen verwenden.

**(USA) (GB) (CDN) (M) (IRL) WARNING!**

Only to be used in water in which the child is within its depth and under adult supervision.

**(F) (CDN) (B) (L) (CH) ATTENTION!**

À n'utiliser qu'en eau où l'enfant a pied et sous la surveillance d'un adulte.

**(E) (MEX) ¡ADVERTENCIA!**

Utilizar sólo en agua donde el niño pueda permanecer de pie y bajo vigilancia de un adulto.

**(NL) (B) WAARSCHUWING!**

Gebuiken in water waar kinderen kunnen staan en onder toezicht van volwassenen.

**(I) (CH) AVVERTENZA!**

Da utilizzare unicamente in acqua dove il bambino tocca il fondo con i piedi e sotto la eglianza di un adulto.

**(P) ATENÇÃO!**

Só utilizar em água onde a criança tenha pé e sob vigilância de adultos.

**(DK) ADVARSEL!**

Må kun anvendes under opsyn af en voksen og på vanddybder, hvor barnet kan bunde.

**(N) ADVARSEL!**

Skal kun brukes i vann som ikke er for dypt for barnet, og der barnet er under tilsyn.

**(S) (FIN) VARNING!**

Får endast användas i vatten där barnet bottnar och under tillsyn av en vuxen.

**(FIN) VAROITUS!**

Lelua saa käyttää vain aikuisen valvonnassa vedessä, jossa lapsi ylettyy pohjaan.

**(H) FIGYELMEZTETÉS!**

Csak a gyermek magasságához képest biztonságos sekély vízben és felnőtt felügyelete mellett szabad használni!

**(CZ) UPOZORNĚNÍ!**

Používat pouze ve vodě takové hloubky, kde dítě stačí, a pouze pod dohledem dospělé osoby.

**(EST) HOIATUS!**

Kasutada ainult täiskasvanu järelevalve all vees, kus laps ulatub jalgadega põhja.

**(LV) BRĪDINĀJUMS!**

Lietot tikai seklā ūdenī un pieaugušo uzraudzībā.

**(LT) ĮSPĖJIMAS!**

Naudoti tik vaikui tinkamame gylyje ir prižiūrint suaugusiesiems.

**(SLO) OPOZORILO!**

Uporabljajte samo v vodi, primerno plitvi za otroka in pod nadzorom odrasle osebe.

**(SK) UPOZORNENIE!**

Používať len vo vode, v ktorej dieťa dočiahne na dno, a pod dohľadom dospelšej osoby.

**(PL) OSTRZEŻENIE!**

Do używania jedynie w wodzie na głębokości, na której dziecko wyczuwa dno pod nogami oraz pod nadzorem osoby dorosłej.

**(TR) (CY) ΔΙΚΚΑΤ!**

Sadece denetim altında ve sadece alçak sularda kullanın.

**(GR) (CY) Προειδοποίηση!**

Na χρησιμοποιείται μόνο σε νερά όπου πατώνει το παιδί και υπό την επίβλεψη ενηλίκου.

**(RO) AVERTISMENT!**

A se utiliza numai acolo unde copilul poate sta în picioare în apă și este sub supraveghere.

**(BG) Внимание!**

Да се използва само във вода, която е дълбока до нормалния ръст на детето, и под надзора на възрастен.

**(HR) UPOZORENJE!**

Koristiti samo u plitkoj vodi pod nadzorom odraslih.

**(CN) 警告!** 可供孩子在水中使用，但必须在有人监护的情况下。



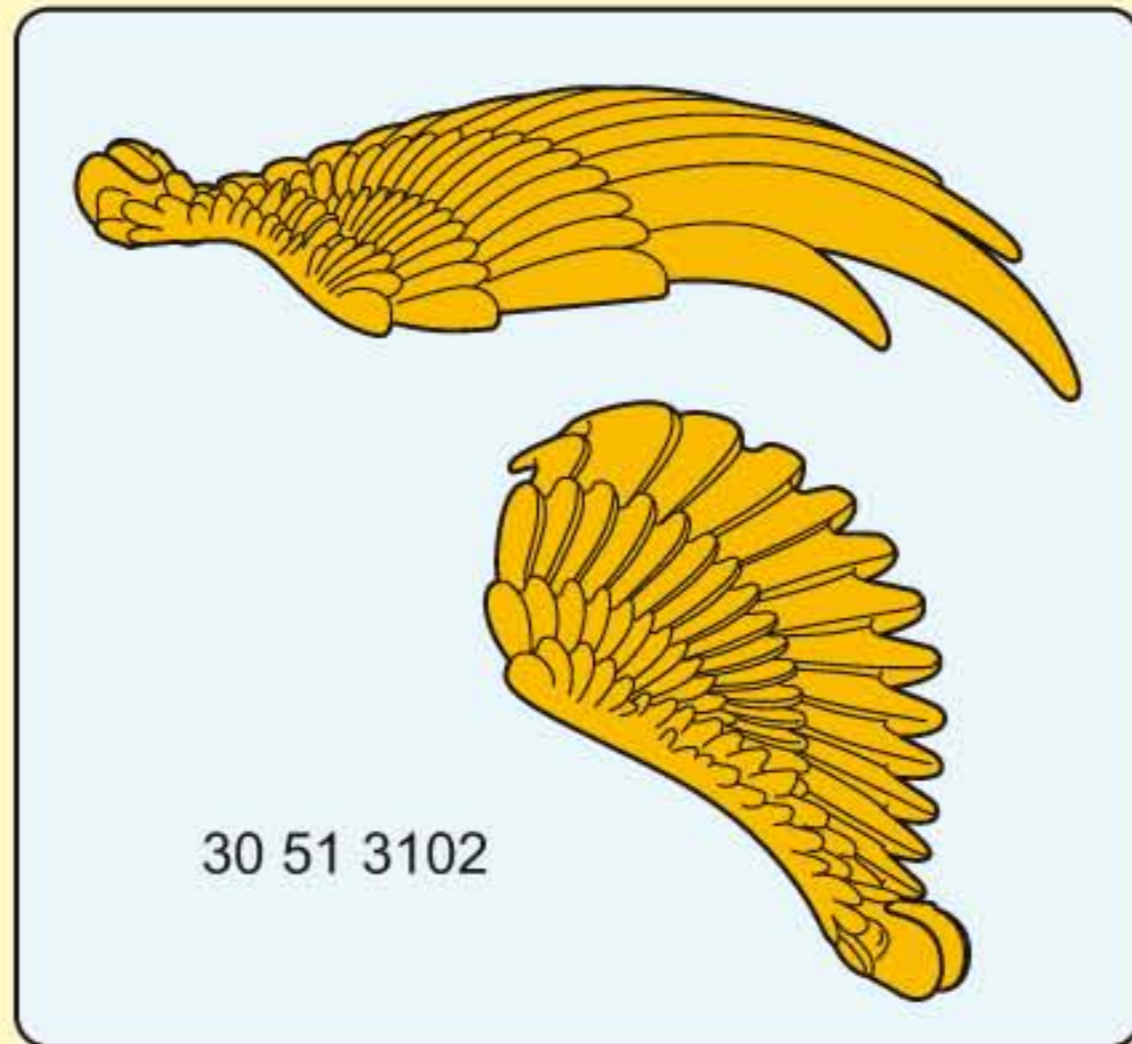
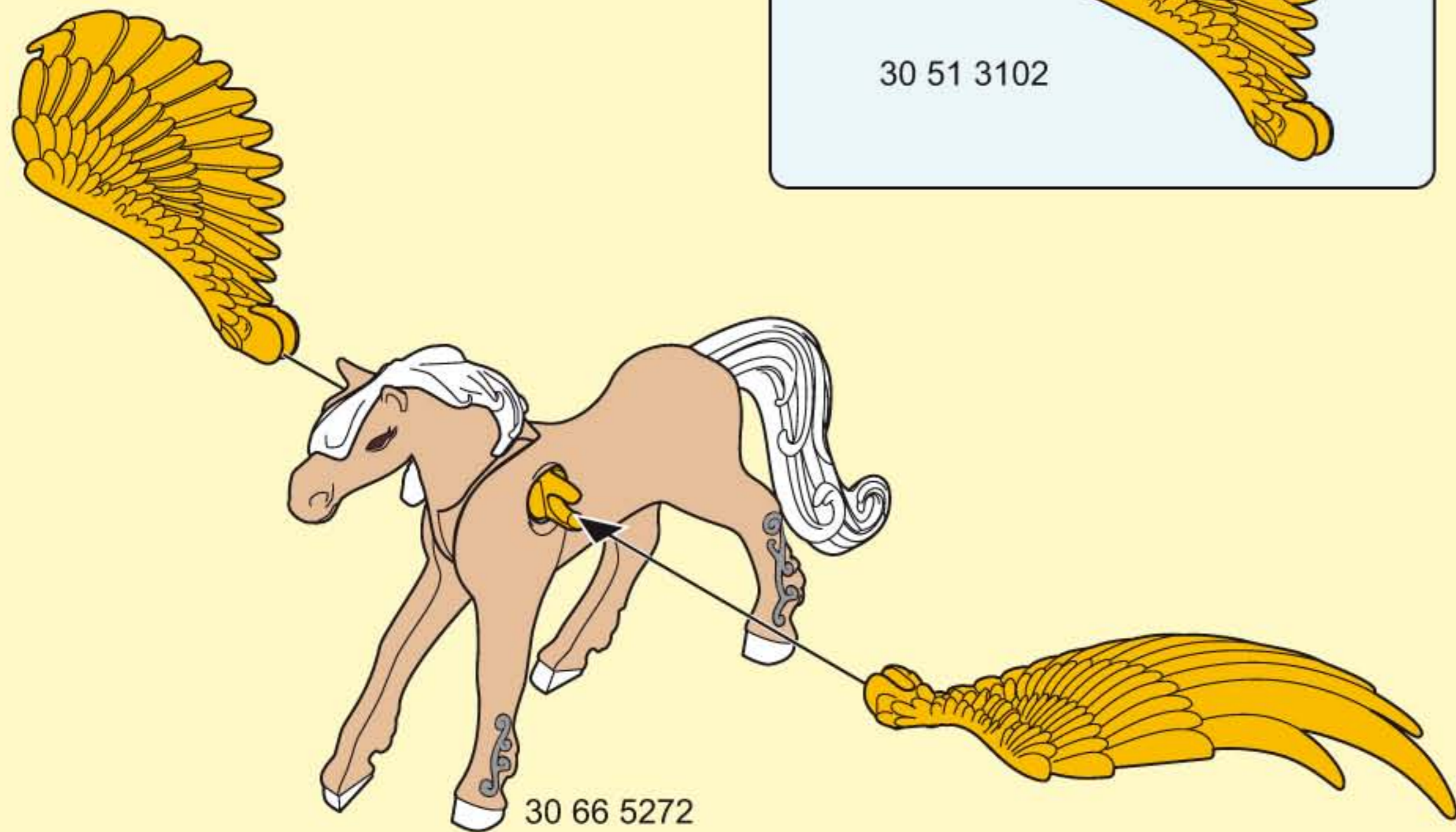

30 20 4730



30 02 6820





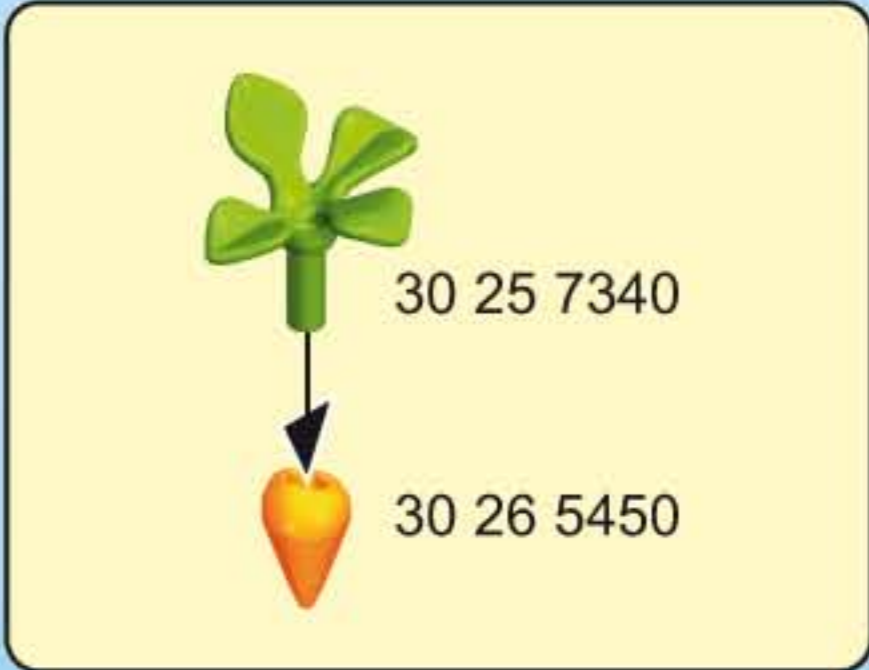
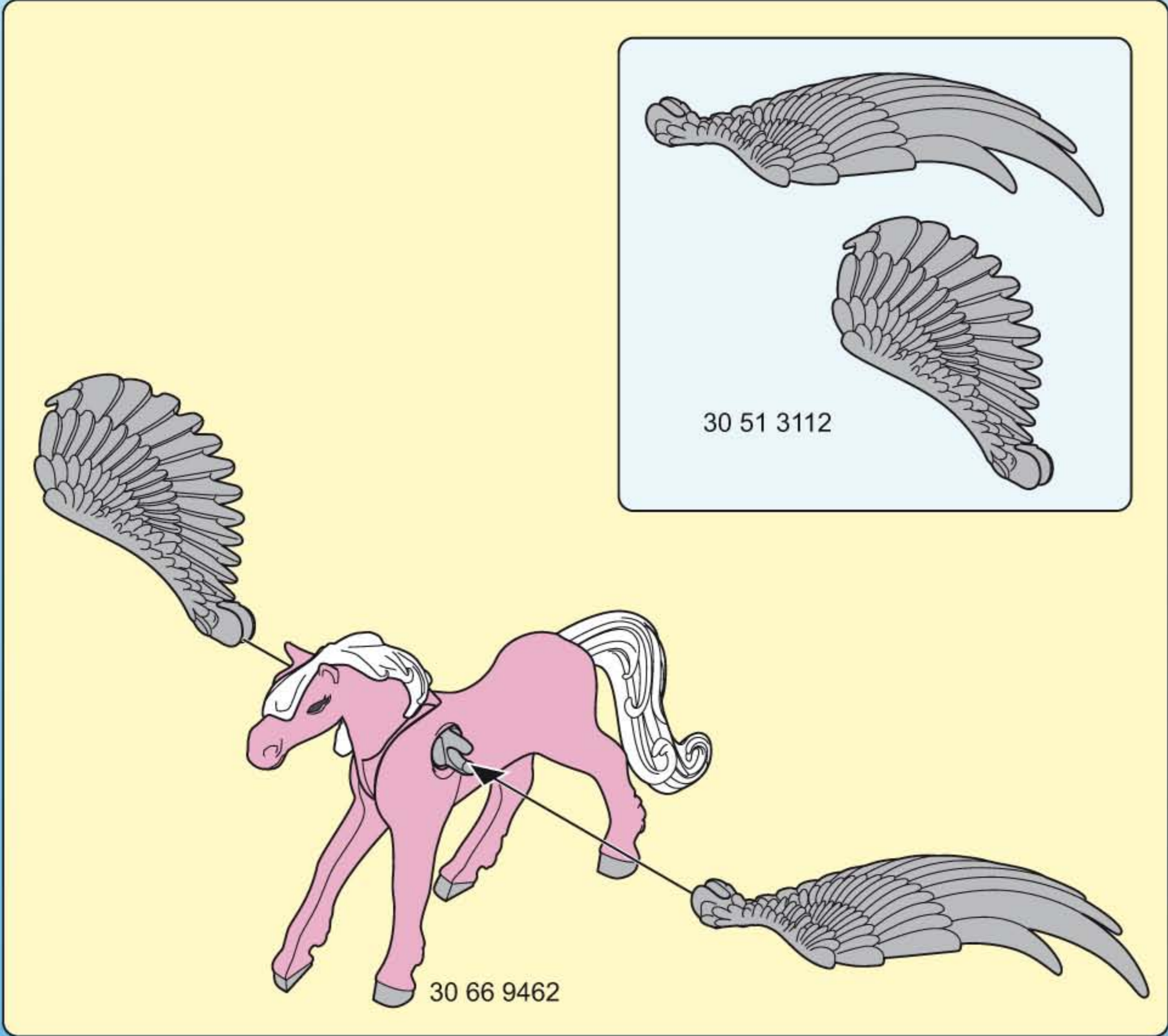



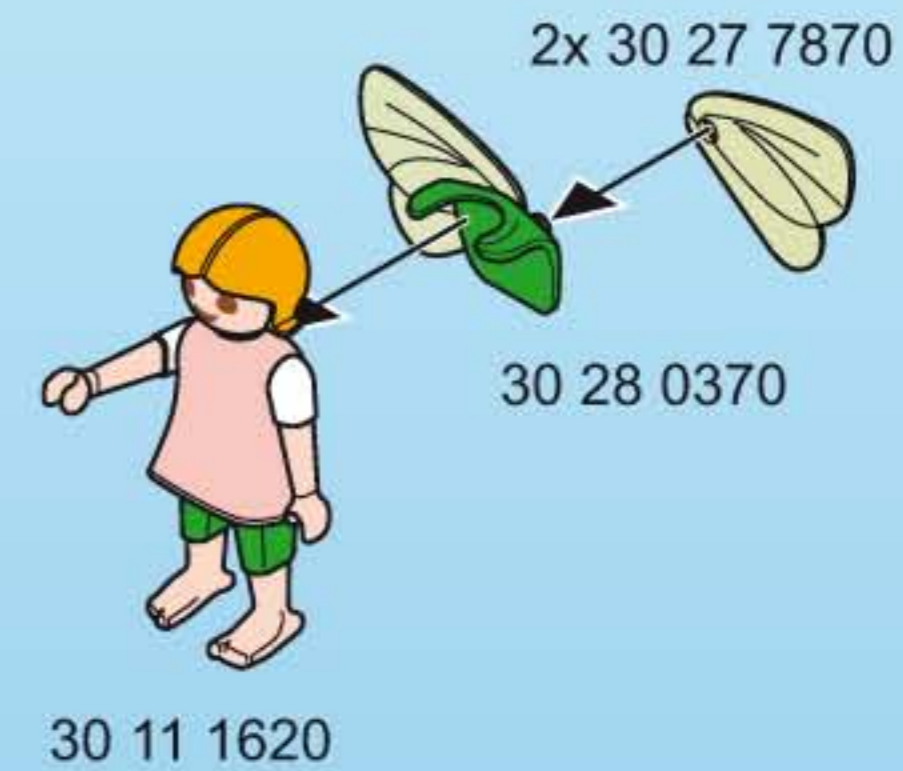
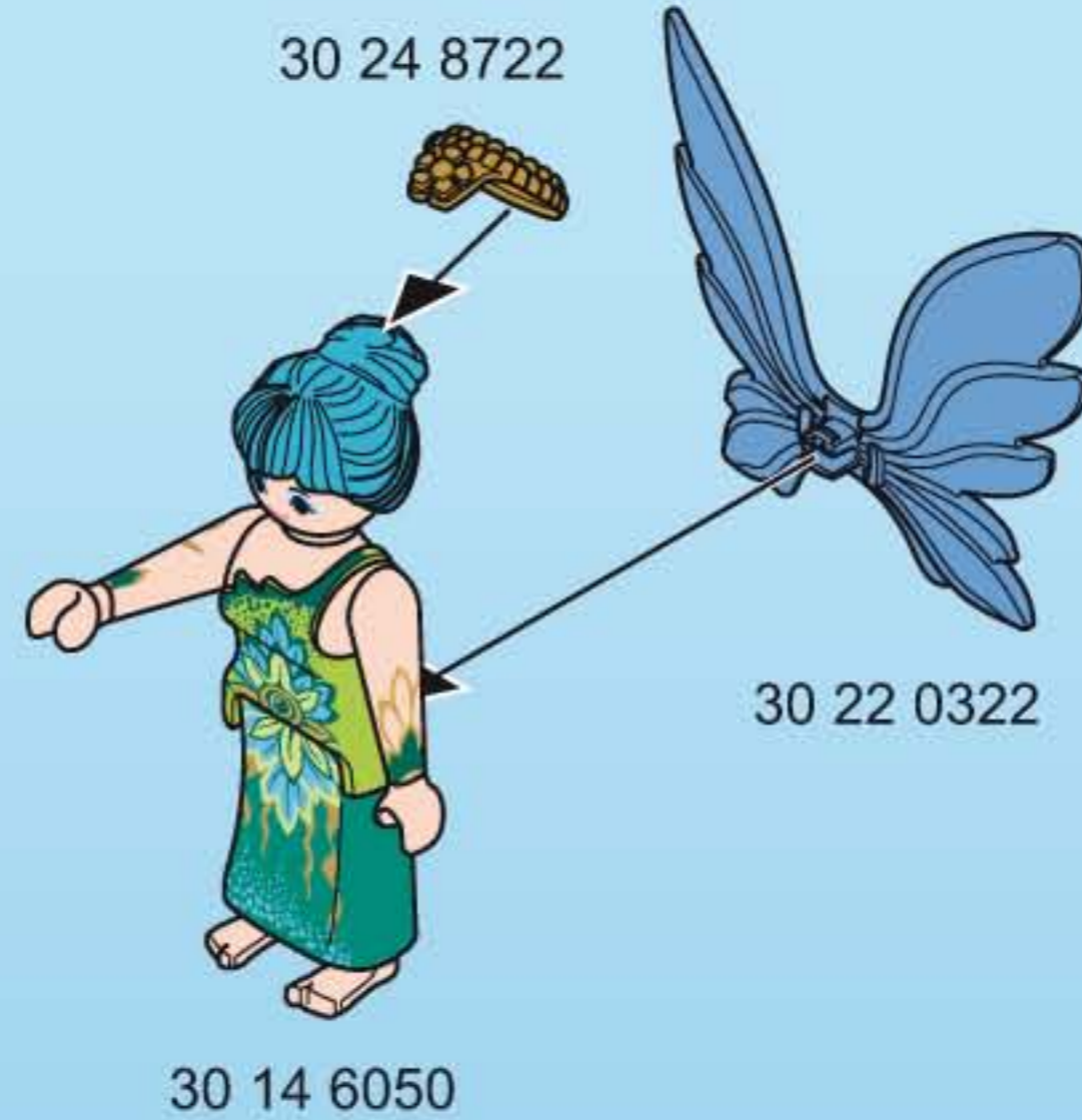
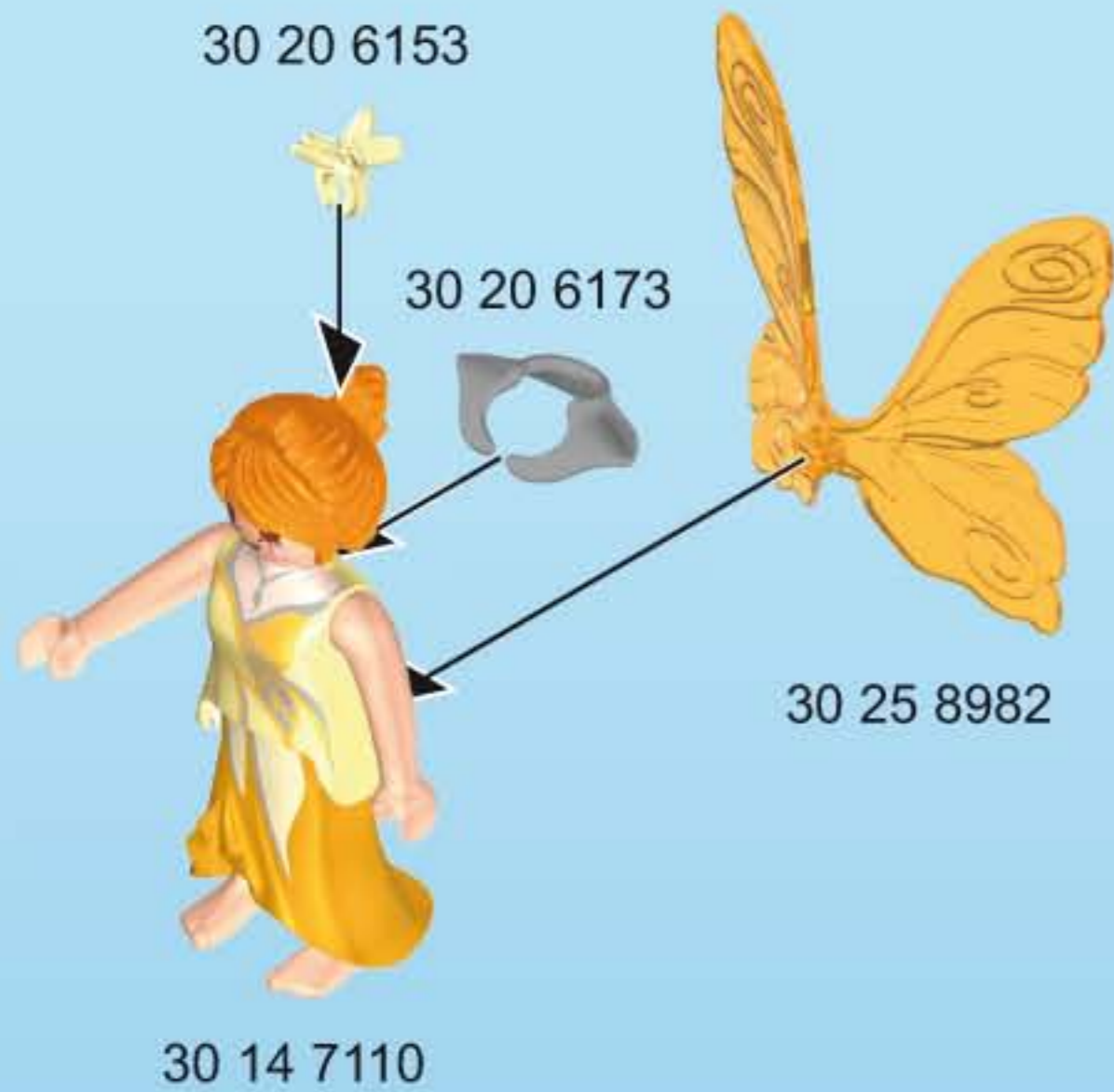

Serviceadressen finden Sie in allen Playmobil-Prospekten	In alle PLAYMOBIL catalogi vindt u het adres van onze klantendienst.
Addresses of Customer Service Departments are shown in all Playmobil catalogues	Las Direcciones de los Departamentos de Servicio al Consumidor se encuentran en todos los catálogos Playmobil
L'adresse du service consommateurs est indiquée dans tous les catalogues Playmobil	Η διεύθυνση του Γραφείου Εξυπηρέτησης Καταναλωτών PLAYMOBIL βρίσκεται σε όλους τους καταλόγους PLAYMOBIL.
Troverete gli indirizzi dei centri di assistenza in tutti i cataloghi Playmobil	pronounce: plāy-mō-bēēl



© 2015 geobra Brandstätter Stiftung & Co.KG  
 Brandstätterstr. 2-10  
 90513 Zirndorf, Germany.  
 No. 30 82 8673 04.15

www.playmobil.com