

playmobil

5574

Wichtige Unterlagen, bitte sorgfältig aufbewahren!
Important: Please keep these instructions for future reference!
Documents importants, à conserver soigneusement!
Belangrijke documenten, bewaar deze zorgvuldig!



WARNING:
CHOKING HAZARD

Small parts. Not for children under 3 years.

"Ne concerne que les USA"



1

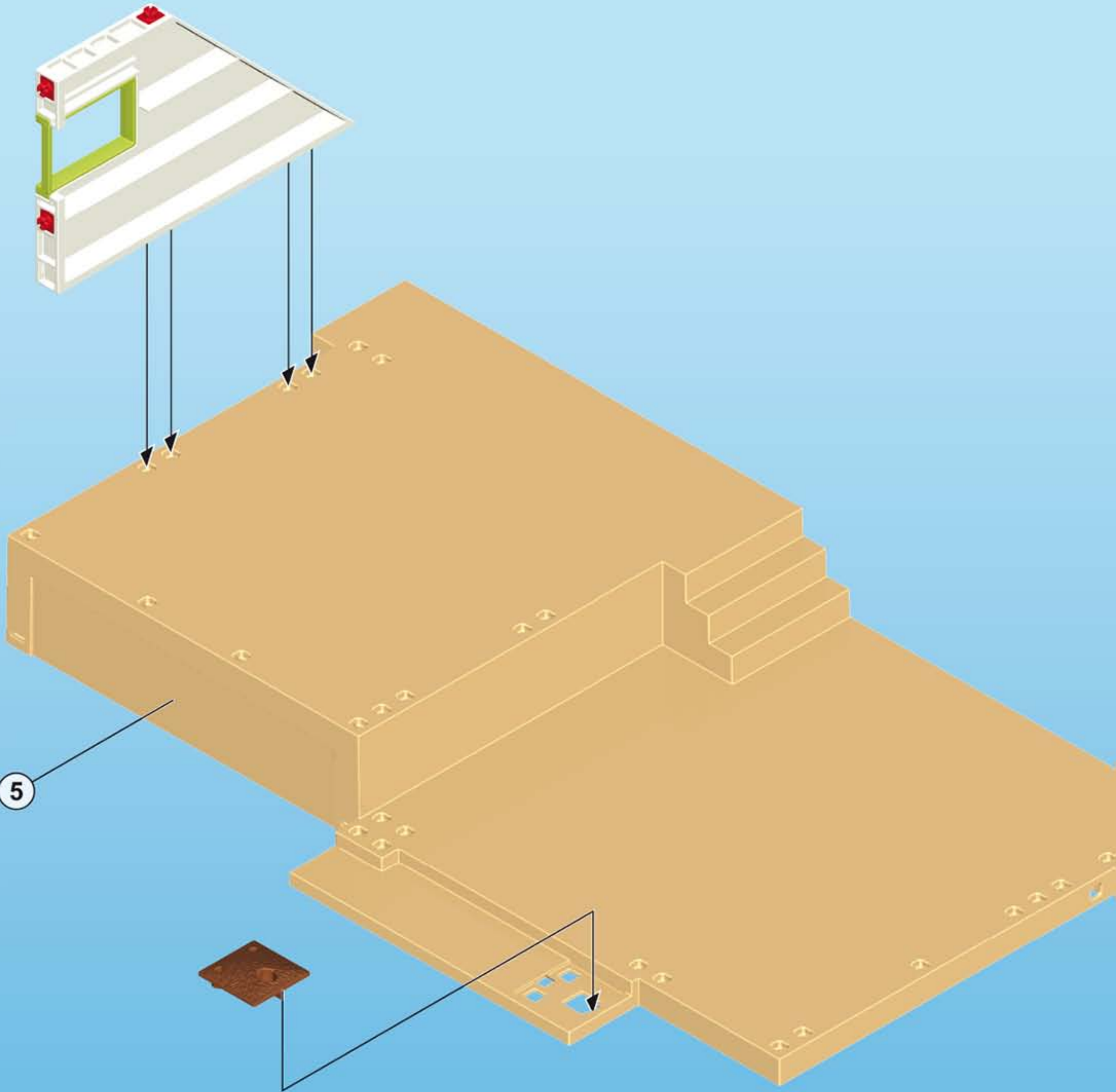
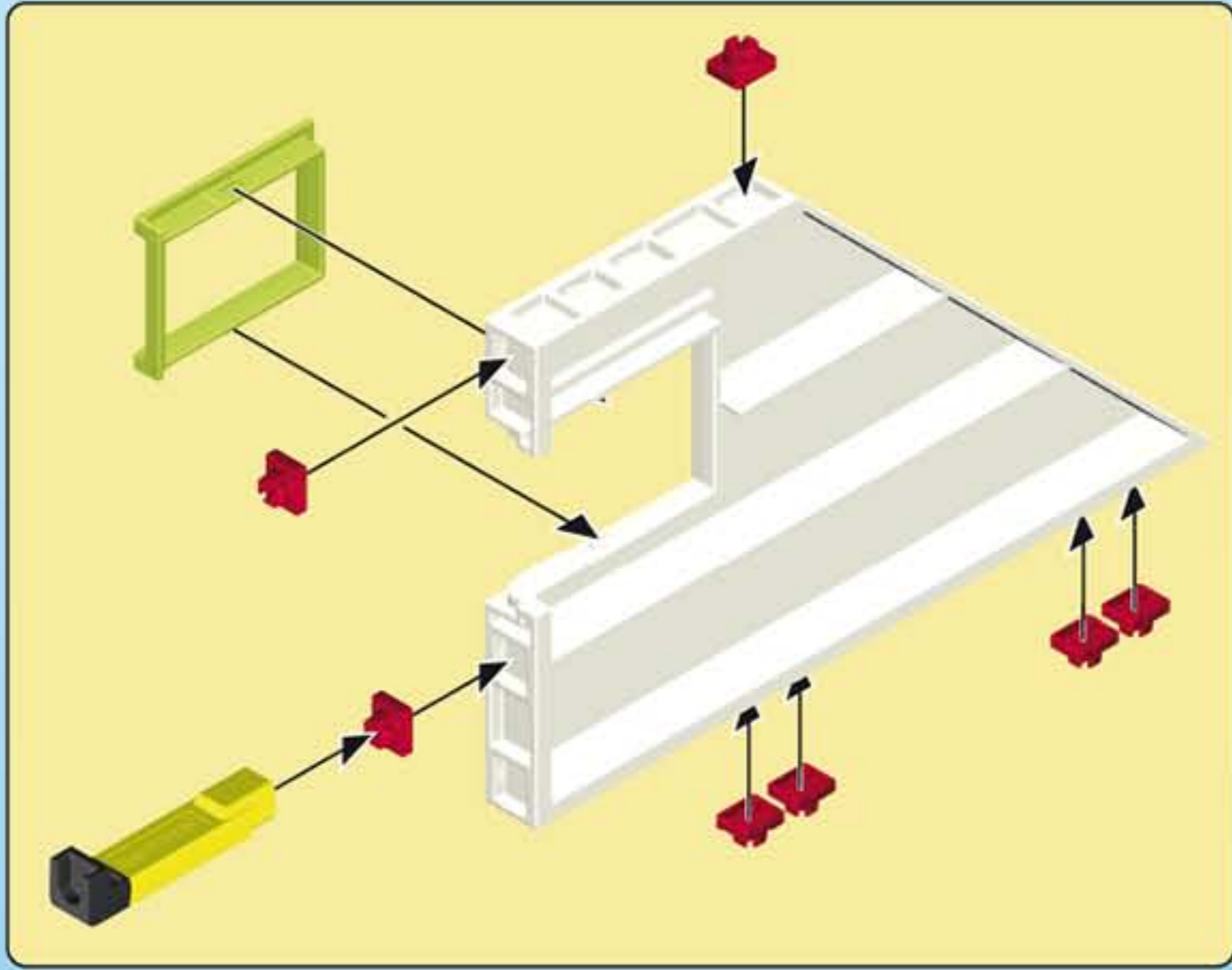

5

2

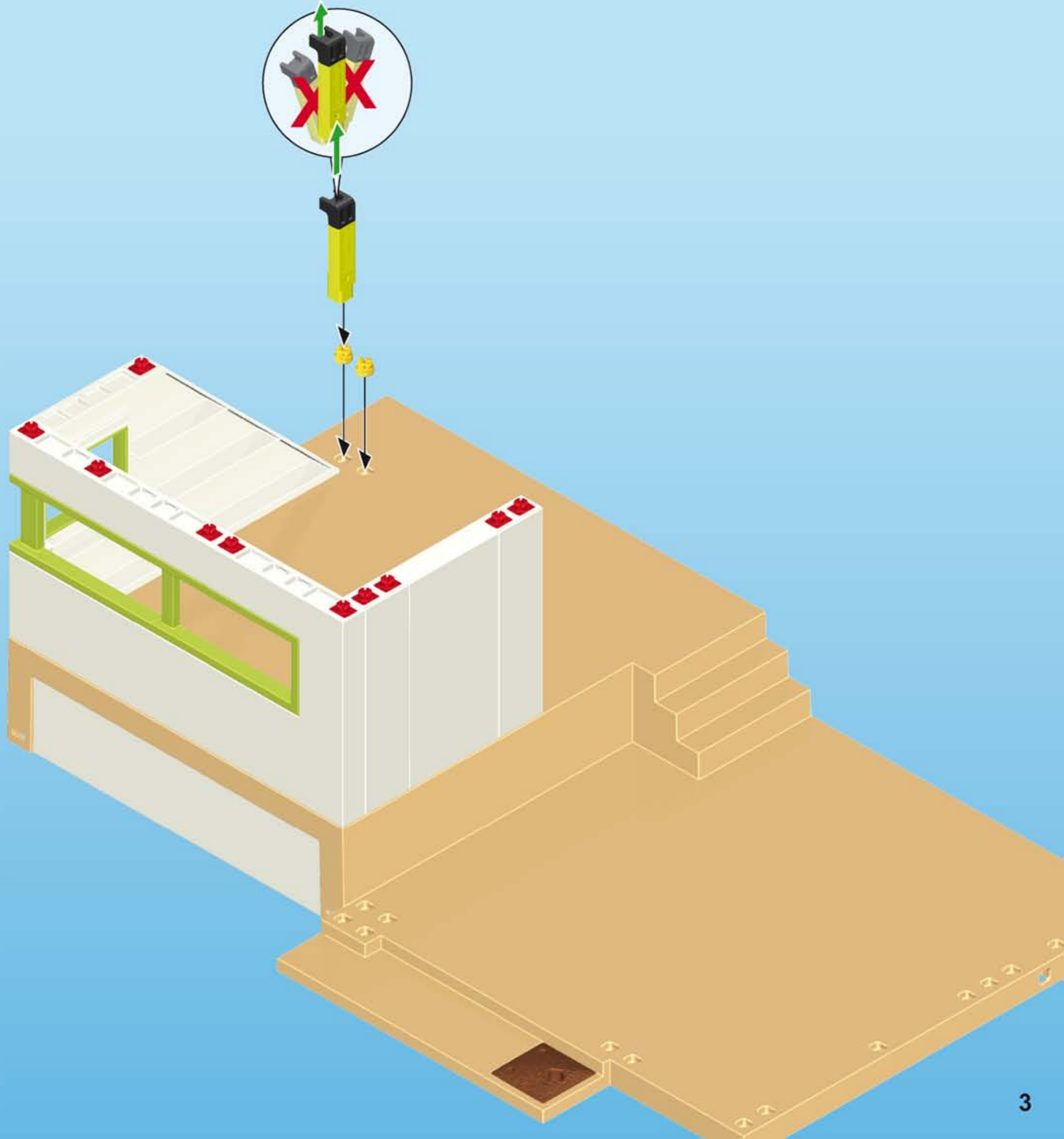
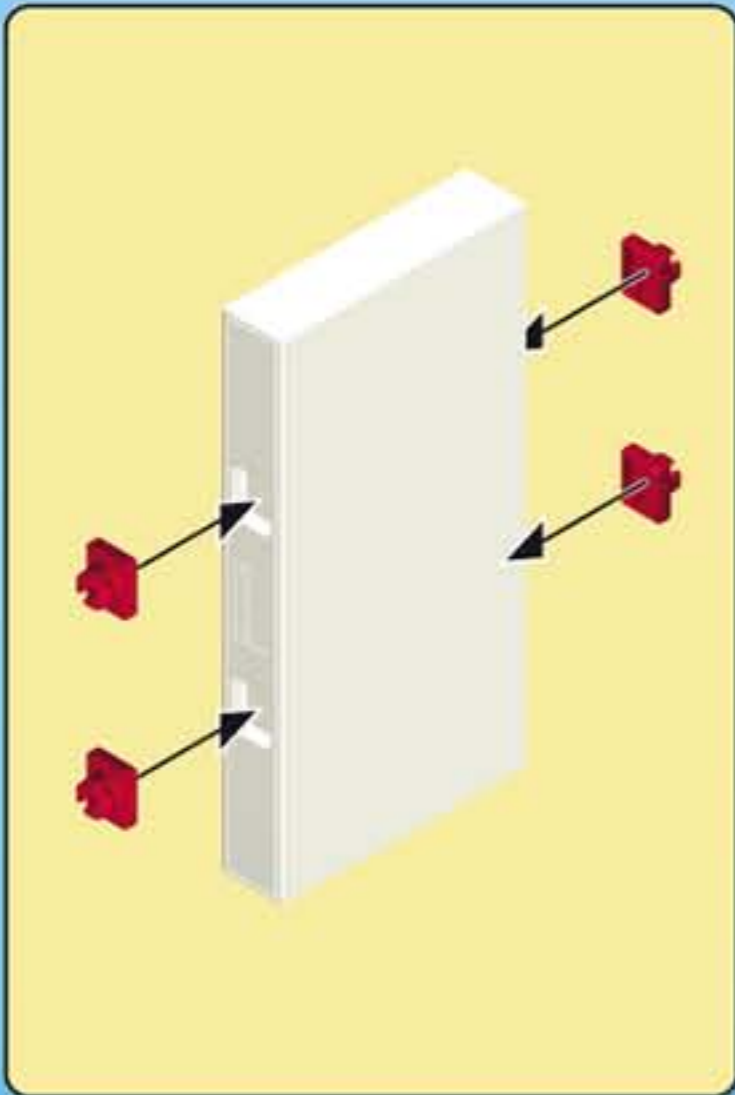
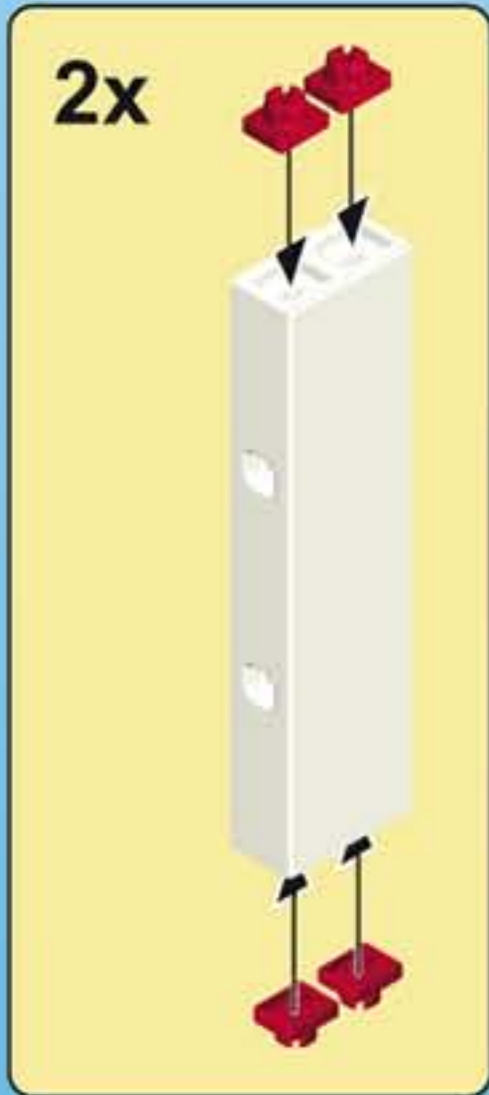
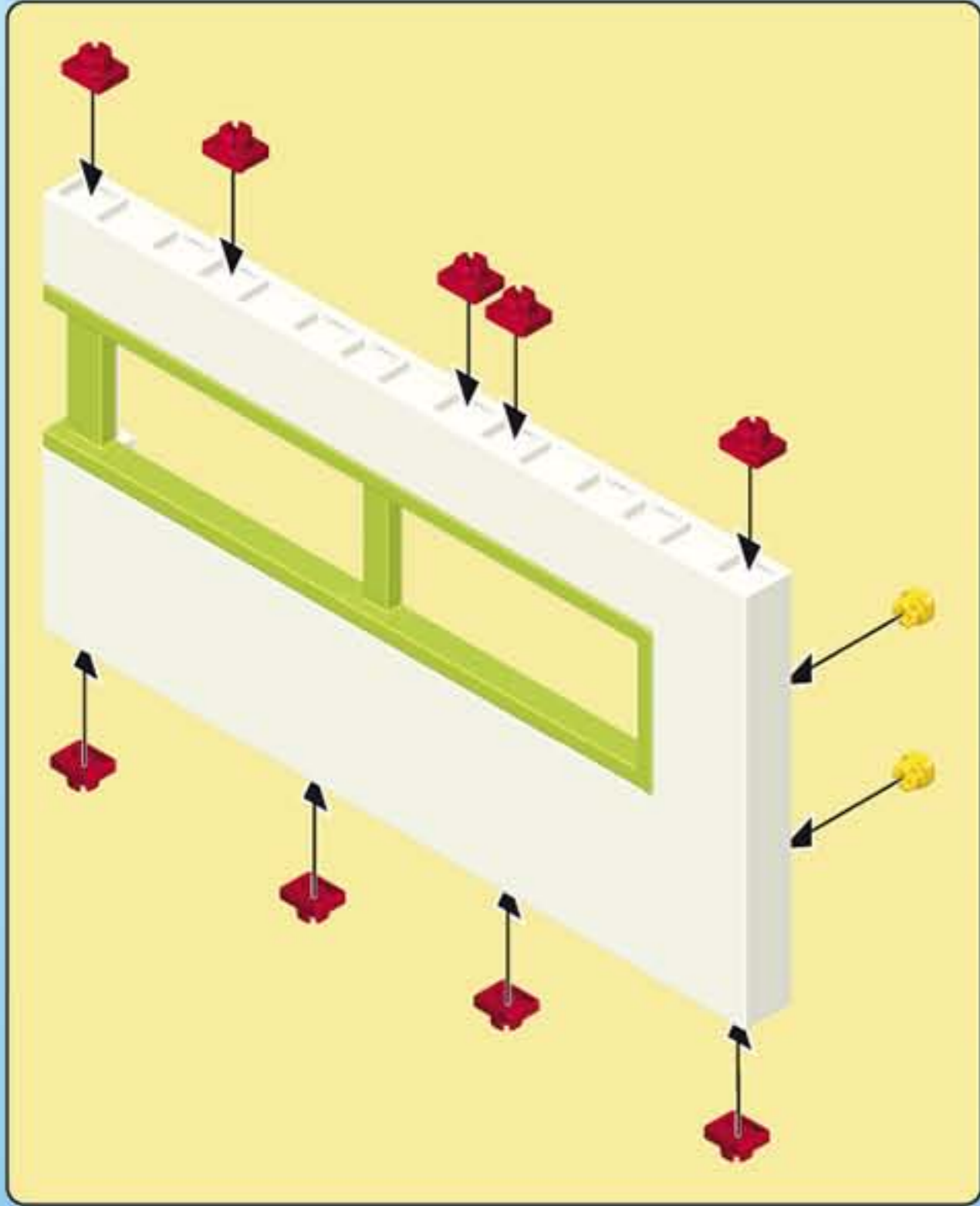

1

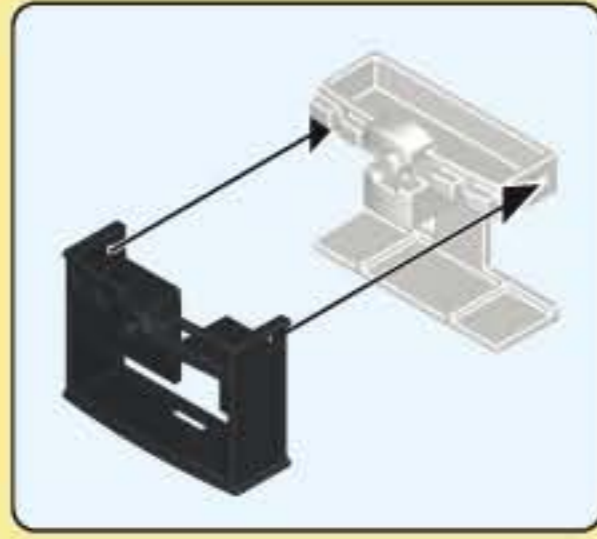

2

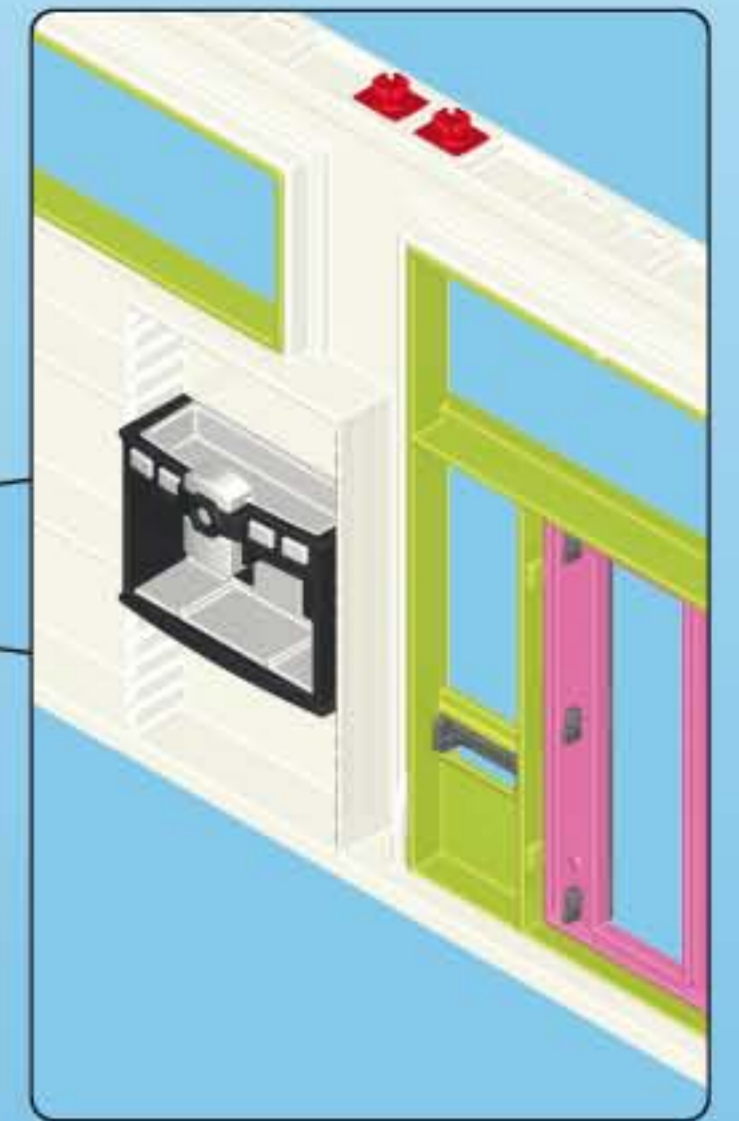
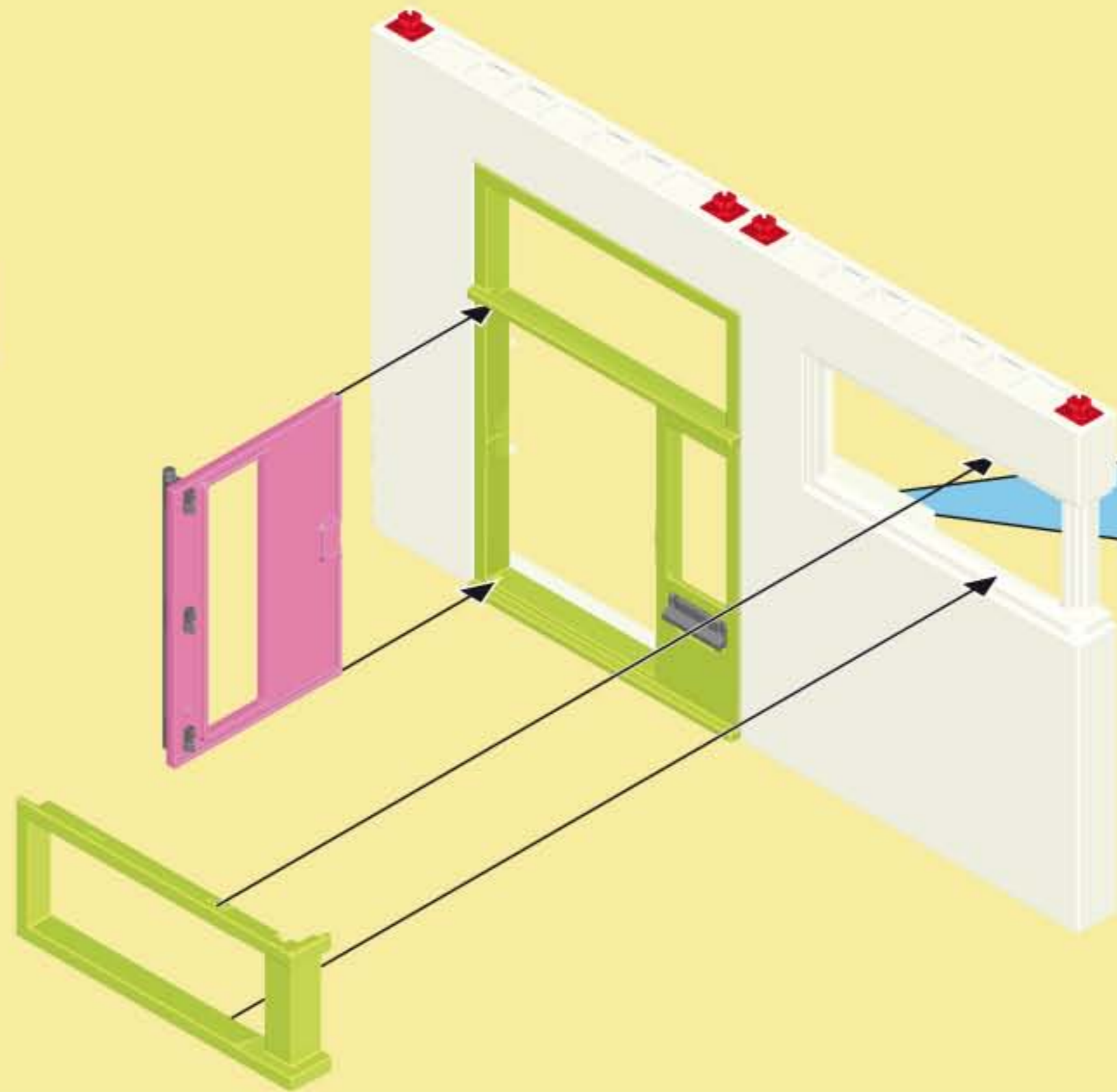
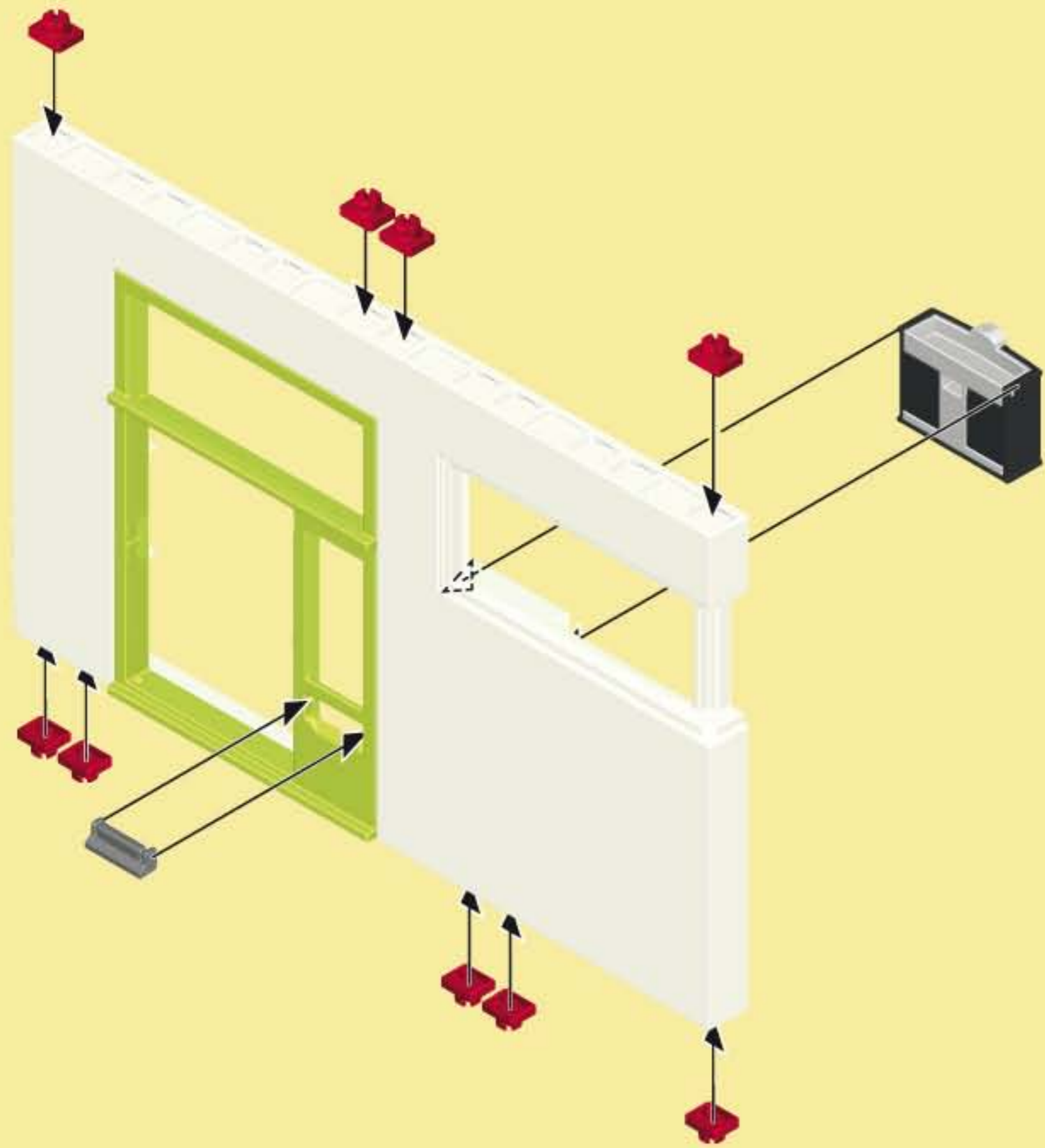
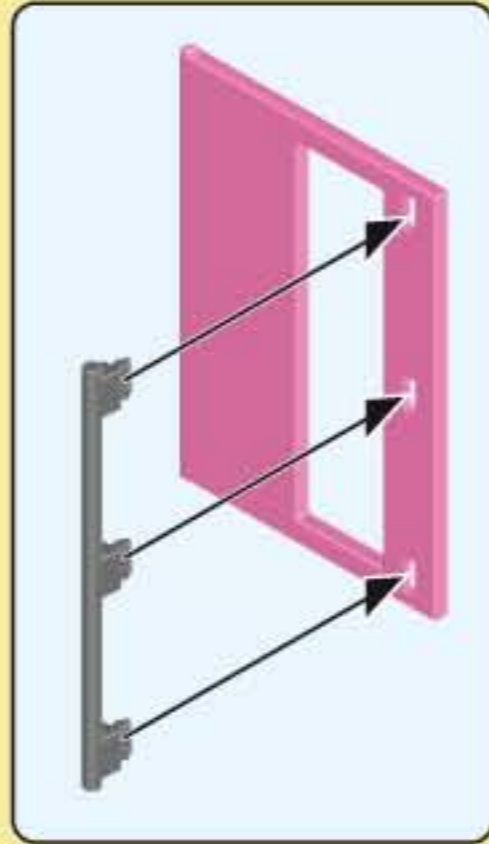

3

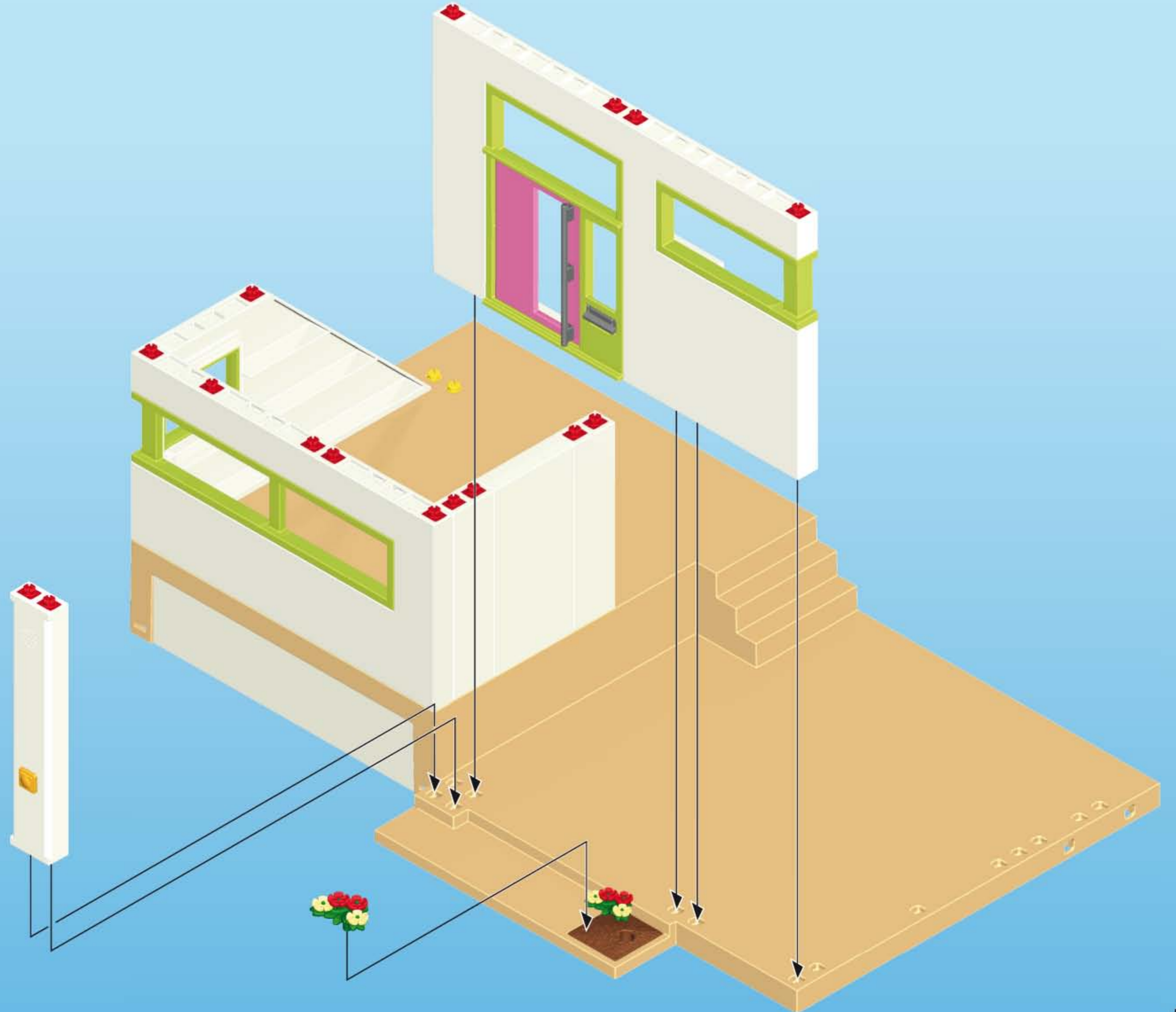
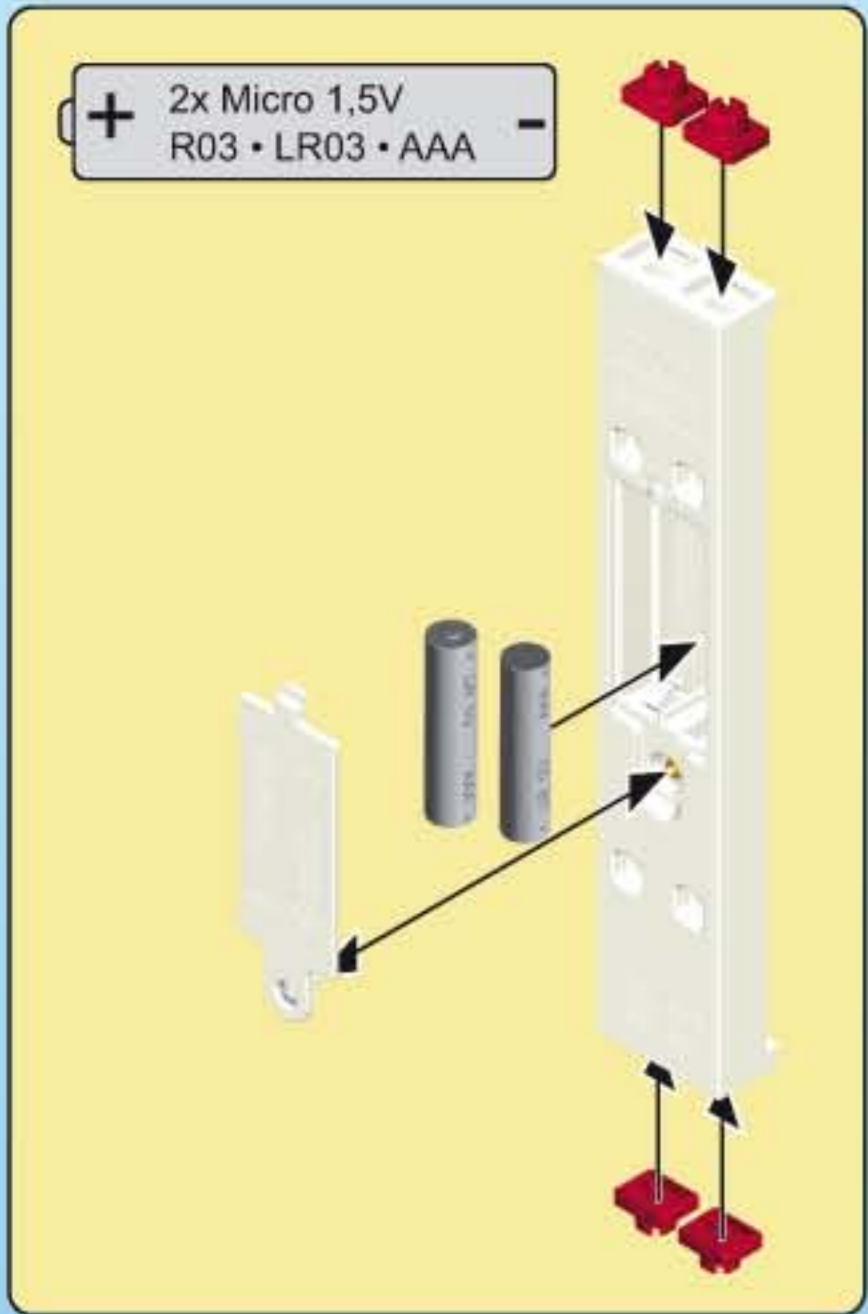

<p>(D) (A) (CH) (L) (B) Nur angegebene Batterien verwenden. Nicht wiederaufladbare Batterien dürfen nicht geladen werden. Aufladbare Batterien dürfen nur unter Aufsicht von Erwachsenen geladen werden. Aufladbare Batterien sind aus dem Spielzeug herauszunehmen, bevor sie geladen werden. Ungleiche Batterietypen oder neue und gebrauchte Batterien dürfen nicht zusammen verwendet werden. Batterien müssen mit der richtigen Polarität eingelegt werden. Leere Batterien müssen aus dem Spielzeug herausgenommen werden. Die Anschlussklemmen dürfen nicht kurzgeschlossen werden. Batterien regelmäßig auf Auslaufen überprüfen. Verbrauchte Batterien nicht in den Hausmüll werfen, sondern nur bei den bestehenden Sammelstellen oder einem Sondermüllplatz abgeben.</p>	<p>(LV) Izmantot tikai norādītās baterijas. Neuzlādēt baterijas, kuras nedrīkst atkārtoti uzlādēt. Uzlādējamas baterijas drīkst uzlādēt tikai pieaugušo uzraudzībā. Uzlādējamas baterijas pirms uzlādēšanas izņemt no transportlīdzekļa. Neizmanto kopā atšķirīgus bateriju tipus vai jaunās un lietotas baterijas. Ievietojot baterijas, ievērot polaritāti. Tukšas baterijas no rotālīetas jāizņem. Pieslēguma spaiļes nedrīkst saslēgt īslēgumā. Regulāri pārbaudīt, vai baterijas nav iztecējušas. Lietotas baterijas neizmest kopā ar sadzīves atkritumiem, bet gan esošajās bateriju savākšanas vietās vai speciālā atkritumu izvešanas vietā.</p>
<p>(USA) (GB) (CDN) (M) (IRL) Only use the stipulated batteries. Non-rechargeable batteries are not to be charged. Rechargeable batteries are only to be charged under adult supervision. Rechargeable batteries are to be removed from the toy before they are recharged. Neither different battery types nor new and used batteries are to be used together. Batteries must be inserted with the correct polarity. Flat batteries are to be removed from the toy. The connecting terminals are not to be short-circuited. Inspect batteries regularly for signs of leakage. Do not dispose of used batteries in the household waste but hand them in at the existing collection points or at a special waste site.</p>	<p>(LT) Naudoiti tik nurodytas baterijas. Vienkartinių baterijų įkrauti negalima. Daugkartinio naudojimo baterijos turi būti įkraunamos suaugusiųjų priežiūroje. Prieš įkraunant daugkartinio naudojimo baterijas, jas reikia išimti iš žaislo. Negalima kartu naudoti skirtingų tipų, arba naujų ir naudotų baterijų. Baterijas reikia įdėti, atsižvelgiant į teisingą poliškumą. Išsikrovusias baterijas reikia išimti iš žaislo. Negalima atlikti trumpo jungiamųjų gnybtų jungimo. Reguliariai tikrinkite ar baterijos nėra išsivėję. Naudotų baterijų negalima išmesti kartu su buitinėmis atliekomis. Jas reikia atiduoti į esamas surinkimo vietas arba į pavojingų atliekų surinkimo aikštelę.</p>
<p>(F) (CDN) (B) (L) (CH) Seulement utiliser le modèle de piles indiqué. Ne pas recharger de piles non rechargeables. Seulement recharger des piles rechargeables en présence d'adultes. Ôter les piles rechargeables du jouet avant de les recharger. Ne pas utiliser de piles de différents types en même temps ni de piles neuves avec des piles anciennes. Attention à introduire correctement les piles en tenant compte de leur polarité. Ôter les piles usées du jouet. Ne pas court-circuiter les bornes. Vérifier régulièrement si les piles coulent. Ne pas jeter de piles usées avec les ordures ménagères, les déposer dans les centres de récupération.</p>	<p>(SLO) Uporabljajte le navedene baterije. Baterij, ki niso namenjene za polnjenje, ni dovoljeno polniti. Baterije, ki se jih sme polniti, je dovoljeno polniti le pod nadzorom odraslih oseb. Pred polnjenjem je baterije, ki se lahko polnijo, potrebno vzeti iz igrache. Skupaj ni dovoljeno uporabljati različnih vrst baterij ali novih in rabljenih baterij. Baterije je potrebno vstaviti pravilno obrnjene – s pravilno polariteto. Prazne baterije je potrebno vzeti iz igrache. Na priključnih sponkah ni dovoljeno povzročati kratkega stika. Redno preverjajte, ali baterije ne iztekajo. Izrabljenih baterij ne odlagajte med gospodinjске odpadke, ampak jih oddajte na zbirnih mestih oz. na zbirališču posebnih odpadkov.</p>
<p>(E) (MEX) Utiliza únicamente las pilas descritas. No recargues pilas no recargables. Recarga las pilas recargables únicamente bajo supervisión de un adulto. Saca las pilas recargables del juguete antes de recargarlas. No utilices juntas pilas de tipos diferentes ni tampoco pilas nuevas con pilas usadas. Inserta las pilas con la polaridad correcta. Saca del juguete las pilas gastadas. No pongas en cortocircuito los bornes de conexión. Comprueba periódicamente si se ha producido una fuga en las pilas. No eches las pilas gastadas a la basura doméstica, deséchalas únicamente en los puestos de recogida previstos o en un depósito de basura especial.</p>	<p>(SK) Používajte len uvedené batérie. Batérie, ktoré nie sú nabíjateľné, sa nesmú nabíjať. Nabíjateľné batérie sa smú nabíjať len pod dohľadom dospelých osôb. Nabíjateľné batérie je potrebné pred nabíjaním vybrať z hračky. Nerovnaké typy batérií alebo nové a použité batérie sa nesmú spoločne používať. Batérie sa musia vložiť so správnou polaritou. Prázdne batérie sa musia z hračky vybrať von. Pripojovacie svorky sa nesmú skratovať. Batérie pravidelne kontrolujte, či nevytekajú. Opatrované batérie nevyhadzujte do domového odpadu, ale ich odovzdajte na existujúcich zberných miestach alebo na skládke špeciálneho odpadu.</p>
<p>(NL) (B) Uitsluitend de aangegeven batterijen gebruiken. Niet-herlaadbare batterijen mogen niet geladen worden. Herlaadbare batterijen mogen alleen onder toezicht van volwassenen geladen worden. Opladbare batterijen moeten uit het speelgoed genomen worden vooraleer ze te laden. Ongelijke batterijtypes of nieuwe of gebruikte batterijen mogen niet samen gebruikt worden. Batterijen moeten met de correcte polen ingelegd worden. Lege batterijen moeten uit het speelgoed genomen worden. De aansluitingsklemmen mogen niet kortgesloten worden. Regelmatig controleren of de batterijen niet uitgelopen zijn. Lege batterijen niet met het huisvuil verwijderen, maar alleen bij bestaande verzamelcentra of een plaats voor bijzondere afval afgeven.</p>	<p>(PL) Stosować tylko wskazane baterie. Zwykłe baterie, nie nadające się do powtórnego ładowania, nie mogą być ładowane. Baterie nadające się do powtórnego ładowania (akumulatorki) mogą być ładowane tylko pod kontrolą osób dorosłych. Przed ładowaniem baterie-akumulator-ki należy wyjąć z zabawki. Nie stosować równocześnie baterii różnych typów ani baterii nowych wraz z używanymi. Podczas zakładania baterii zwrócić uwagę na ich prawidłową polaryzację. Rozładowane baterie usunąć z zabawki. Nie zwierać zacisków. Regularnie sprawdzać, czy baterie nie wyciekają. Zużytych baterii nie wyrzucać do kosza na śmieci, tylko oddać w odpowiednich punktach zbiórki lub wrzucać do przeznaczonych do tego celu specjalnych pojemników.</p>
<p>(I) (CH) Usare solo le batterie indicate. E' vietato utilizzare le batterie ricaricabili. Le batterie ricaricabili devono essere caricate soltanto in presenza di adulti. Le batterie ricaricabili si estraggono dal giocattolo, prima di essere caricate. I tipi di batteria non uguali o nuovi e le batterie esauste non devono essere usate insieme. Le batterie vanno inserite rispettando la corretta polarità. Le batterie esaurite devono essere rimosse dal giocattolo. I morsetti di collegamento non devono essere messi in corto circuito. Verificare ad intervalli regolari che le batterie non si siano esaurite. Le batterie esauste non vanno smaltite insieme ai rifiuti domestici, bensì portate nei punti di raccolta o nei centri di raccolta per rifiuti speciali.</p>	<p>(TR) (CY) Yalnızca belirtilen pilleri kullanınız. Şarj edilemeyen piller şarj edilememelidir. Şarj edilebilir piller yalnızca yetiştirkinlerin gözetiminde şarj edilmelidir. Şarj edilebilir piller, şarj edilmeden önce oyuncak içerisinde çıkarılmalıdır. Türleri birbirinden farklı piller veya yeni ve eski pilleri bir arada kullanmayınız. Piller kutupları doğru olacak şekilde yerleştirilmelidir. Biten piller oyuncak içerisinde çıkarılmalıdır. Bağlantı klemensleri kısa devre yapılmamalıdır. Düzenli aralıklarla pillerin akup akmadıklarını kontrol ediniz. Kullanılmış pilleri ev çöplüne atmayınız, yalnızca özel toplama yerlerine atınız veya özel atık merkezine ulaştırınız.</p>
<p>(P) Usar apenas as pilhas indicadas. Pilhas não recarregáveis não podem ser carregadas. Pilhas recarregáveis só podem ser carregadas sob supervisão de adultos. Pilhas recarregáveis devem ser retiradas do brinquedo, antes de serem carregadas. Não se pode usar em conjunto diferentes tipos de pilha ou pilhas novas e usadas. Pilhas têm de ser inseridas com a polaridade correcta. Pilhas vazias têm de ser retiradas do brinquedo. Não se podem curto-circuitar os terminais. As pilhas têm de ser controladas regularmente quanto a vazamento. Não deitar pilhas gastas no lixo doméstico, mas depositá-las nos pontos de recolha existentes ou entregá-las no estabelecimento que as comercializa.</p>	<p>(GR) (CY) Να χρησιμοποιείτε μόνο μπαταρίες του τύπου που σας υποδεικνύουν οι πληροφορίες ή αντίστοιχες. Ποτέ μην επαναφορτίσετε μη επαναφορτιζόμενες μπαταρίες. Οι επαναφορτιζόμενες μπαταρίες πρέπει να επαναφορτίζονται πάντα από ενήλικα. Αφαιρείτε τις επαναφορτιζόμενες μπαταρίες από την ηλεκτρονική μονάδα του παιχνιδιού πριν τις επαναφορτίσετε. Μην συνδυάζετε μπαταρίες διαφορετικών τύπων, π.χ. αλκαλικές ή επαναφορτιζόμενες με απλές, ή παλιές με καινούργιες. Τοποθετείστε τις μπαταρίες με την σωστή πολικότητα. Όταν αδειάσουν οι μπαταρίες πρέπει να απομακρύνονται από το παιχνίδι. Ποτέ μη βραχυκυκλώνετε τους πόλους. Πάντα να ελέγχετε τις μπαταρίες για τυχόν διαρροές. Μην πετάτε ποτέ στα οικιακά απορρίμματα τις παλιές μπαταρίες, παρά μόνο σε ειδικούς κάδους ανακύκλωσης με την αντίστοιχη ένδειξη. Για τον κατάλληλο τρόπο ανακύκλωσης, παρακαλούμε επικοινωνήστε με τους τοπικούς φορείς.</p>
<p>(DK) Anvend kun de angivne batterier. Ikke genopladelige batterier må ikke oplades. Genopladelige batterier må kun oplades under opsyn af voksne. Genopladelige batterier skal tages ud af legetøjet, inden de oplades. Forskellige batterityper eller nye og brugte batterier må ikke anvendes sammen. Batterier skal sættes med den rigtige polaritet. Tomme batterier skal tages ud af legetøjet. Tilslutningsklemmeme må ikke kortsluttes. Kontroller regelmæssigt batterierne for lækage. Opbrugte batterier må ikke bortskaffes som almindeligt husholdningsaffald, men skal afleveres på et officielt sted for indsamling af brugte batterier eller på den kommunale genbrugsstation.</p>	<p>(RO) Se vor folosi doar bateriile specificate. Bateriile fără reîncărcare nu au voie să se încarce. Bateriile reîncărcabile se vor încărca doar sub supravegherea adulţilor. Bateriile reîncărcabile se scot din jucărie înainte de încărcare. Nu este permisă utilizarea împreună a bateriilor de tipuri diferite sau a bateriilor noi cu cele vechi. Bateriile trebuie introduse cu polaritatea corectă. Bateriile descărcate trebuie scoase din jucărie. Bornele nu au voie să fie scurtcircuitate. Bateriile trebuie verificate în mod regulat să nu prezinte scurgeri. Bateriile consumate nu se aruncă la deşeurile menajere, ci se predau la centrele existente de colectare sau în locurile pentru deşeuri speciale.</p>
<p>(N) Benytt kun angitte batterier. Batterier som ikke kan gjenopplades må ikke lades opp. Oppladbare batterier må bare lades opp under tilsyn av voksne. Oppladbare batterier må tas ut av leketøyet før de lades opp. Ulike batterityper eller nye og brukte batterier må ikke benyttes sammen. Batterier må legges inn med riktig polaritet. Tomme batterier må tas ut av kjøretøyet. Kopplingsklemmene må ikke kortsluttes. Kontroller batteriene regelmessig for om de lekker ut. Ikke kast oppbrukte batterier i husholdningsavfallet, men lever dem til lokale miljøstasjoner eller til en plass for spesialavfall.</p>	<p>(BG) Използвайте само посочените батерии. Непредназначени за зареждане батерии не бива да бъдат зареждани. Зареждащите се батерии трябва да бъдат зареждани само под надзора на възрастни. Зареждащите се батерии се изваждат от играчката, преди да се поставят за зареждане. Не използвайте заедно нееднакви модели батерии и нови и употребявани батерии не бива да се използват заедно. Поставайте батериите, обръщайки внимание на правилния поларитет. Празните батерии трябва да бъдат изваждани от играчката. Свързващите клеми не трябва да бъдат давани на късо. Редовно проверявайте батериите за течове. Не изхвърляйте употребяваните батерии като домакински отпадък, а ги предавайте само на специално определените за това места или в депо за специални отпадъци.</p>
<p>(S) (FIN) Använd endast angivna batterier. Batterier som inte är uppladdbara får inte laddas. Uppladdbara batterier får endast laddas om en vuxen person hjälper dig. Ta ur de uppladdbara batterierna ur fordonet innan de laddas. Använd inte olika batterityper samtidigt, använd heller inte ett nytt och ett gammalt batterie samtidigt. Se till att batterierna ligger åt rätt håll, det finns symboler på batterierna och i batterifacket. Ta ur tomma batterier ur leksaken. Lägg inte ihop anslutningsklimmorna, de kan bli kortslutning. Kontrollera regelbundet att batterierna inte läcker batterisyra. Gamla batterier hör inte hemma i vanliga hushållsopor. Kasta batterier i speciella batteriuppsamlare eller lämna dem till sopptippen som specialavfall.</p>	<p>(HR) Koristiti samo navedene baterije. Baterije za ponovno punjenje se ne smiju koristiti. Baterije za ponovno punjenje se smiju puniti samo pod nadzorom odraslih. Baterije za ponovno punjenje se prije punjenja moraju izvaditi iz igrache. Baterije raznih tipova ili nove i rabljene se ne smiju skupa upotrebljavati. Baterije se moraju umetnuti sa točnim polaritetom. Prazne baterije se moraju izvaditi iz igrache. Priključne stazaljke se ne smiju kratko spojati. Baterije redovito provjeravati u svezi curenja. Istrošene baterije ne bacati u kućno smeće, već ove odnijeti na postojeća sabirna mjesta ili predati na jedno mjesto za posebno smeće.</p>
<p>(FIN) Käytä vain ilmoitettuja paristoja. Ei saa ladata paristoja, jotka eivät ole ladattavia. Ladattavat paristot saa ladata vain aikuisen valvonnassa. Ladattavat paristot on poistettava leikkikalusta ennen lataamista. Erilaisia paristotyyppejä tai uusia ja käytettyjä paristoja ei saa käyttää yhdessä. Paristot on asetettava paikoilleen navat oikein päin. Tyhjät paristot on poistettava leikkikalusta. Liittimien oikosulku ei ole sallittua. Tarkista säännöllisesti, että paristot eivät vuoda. Älä heitä käytettyjä paristoja talousjätteeseen, vain toimita ne vain asiantuuluvuvin keräyspisteisiin tai ongelmajätetapaikkaan.</p>	<p>(CN) 只限使用规定的电池类型。非充电电池不能充电。充电电池只能在成年人监督下充电！充电电池在充电前应该从玩具中取出。不同类型的电池或新旧电池不能混用！电池应以正确的极性放入。用尽的电池应从玩具中取出。电源端子不得短路。用过的旧电池请勿随意丢弃在家庭垃圾中，而是放入回收站或者交给特殊处理处。</p>
<p>(H) Csak a megadott elemeket szabad használni. A nem töltethető elemek töltése tilos. A töltethető elemeket csak felnőttek felügyelete mellett szabad tölteni. A feltölthető elemeket ki kell venni a játékból a töltés előtt. Nem egyforma típusú elemek, vagy új és használt elemek együtt nem használhatók. Az elemeket a megfelelő polaritással kell behelyezni. A lemerült elemeket ki kell venni a játékból. A csatlakozó kapcsokat nem szabad rövidre zární. Rendszeresen ellenőrizni kell, hogy az elemek nem folynak-e. A használt elemeket nem szabad a háztartási szeméthe dobni, hanem le kell adni egy gyűjtőhelyen vagy veszélyes hulladék állomáson.</p>	<p>(CZ) Používejte pouze uvedené baterie. Baterie, které není možno dobíjet, nesmějí být nabíjeny. Nabíjecí baterie smějí být nabíjeny pouze pod dohledem dospělých osob. Nabíjecí baterie musejí být před nabitím vyjmuty z hračky. Různé typy baterií nebo nové a použité baterie nesmějí být použity společně. Je nutno vložit baterie se stejnou polaritou. Prázdné baterie je nutno z hračky vyndat. Připojovací svorky nesmějí být spojeny nakrátko. Pravidelně kontrolujte, zda baterie nevytékají. Použité baterie neházejte do domovního odpadu, pouze je odevzdejte na stávající sběrná místa nebo stanoviště pro nebezpečný odpad.</p>
<p>(EST) Kasutage ainult lubatud patareisid. Laadimisvõimaluseta patareisid on keelatud laadida. Laadimisvõimalusega patareisid tohib laadida ainult täiskasvanud isiku järelevalve all. Laadimisvõimalusega patareid tuleb enne laadimise alustamist mänguasja seest välja võtta. Ärge kasutage korraga erinevat tüüpi või uusi ja kasutatud patareisid. Jälgige patareide paigaldamisel õiget polaarsust. Tühjad patareid tuleb mänguasja seest välja võtta. Uhendusklennide lühistamine on keelatud. Kontrollige patareisid regulaarselt, et nad ei eraldaks vedelikku. Ärge visake kasutuskõlbmatuid patareisid majapidamisprügi hulka vaid andke need vastavatesse kogumiskohtadesse või ohtlike jäätmete kogumispunktidesse.</p>	

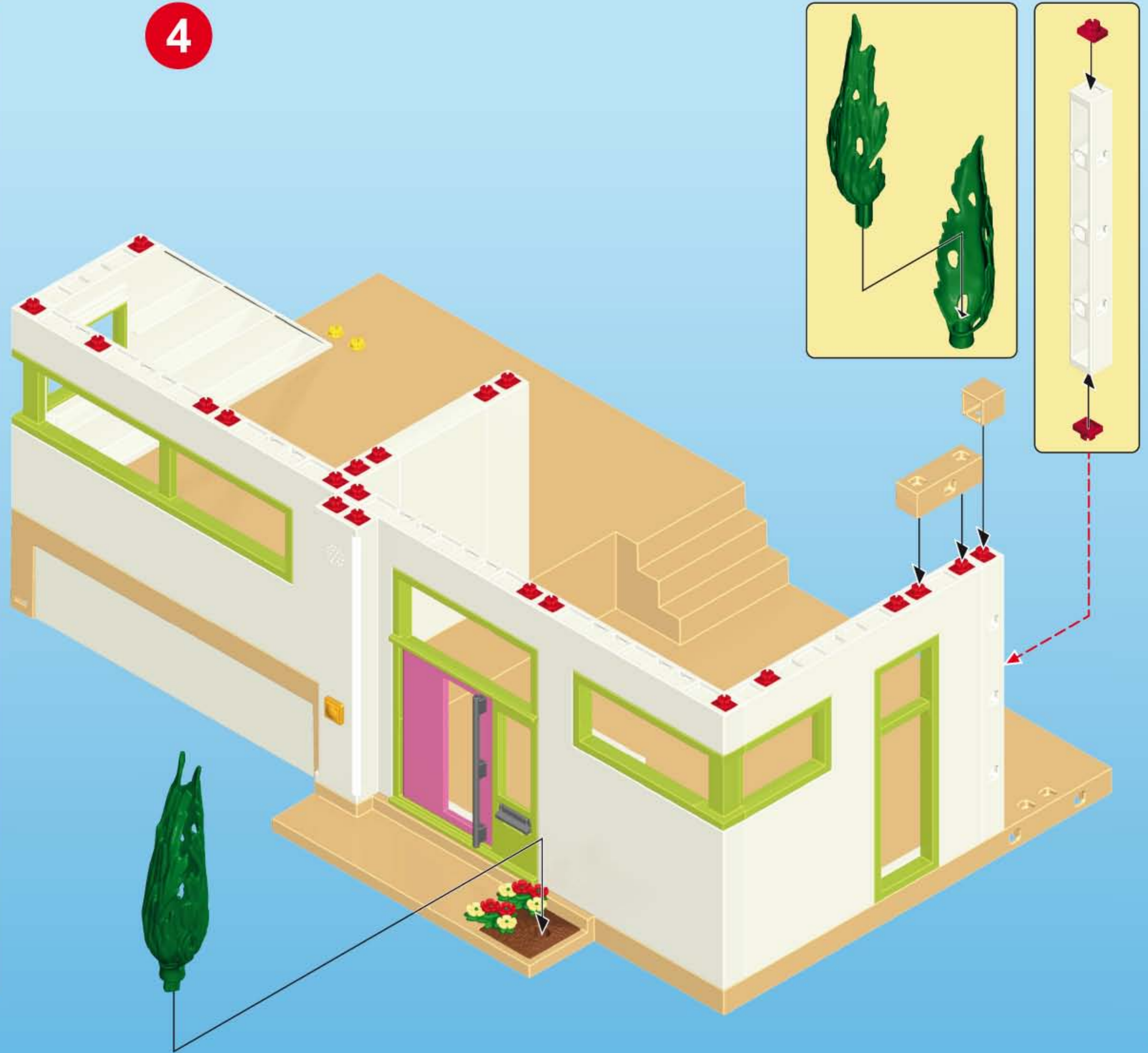
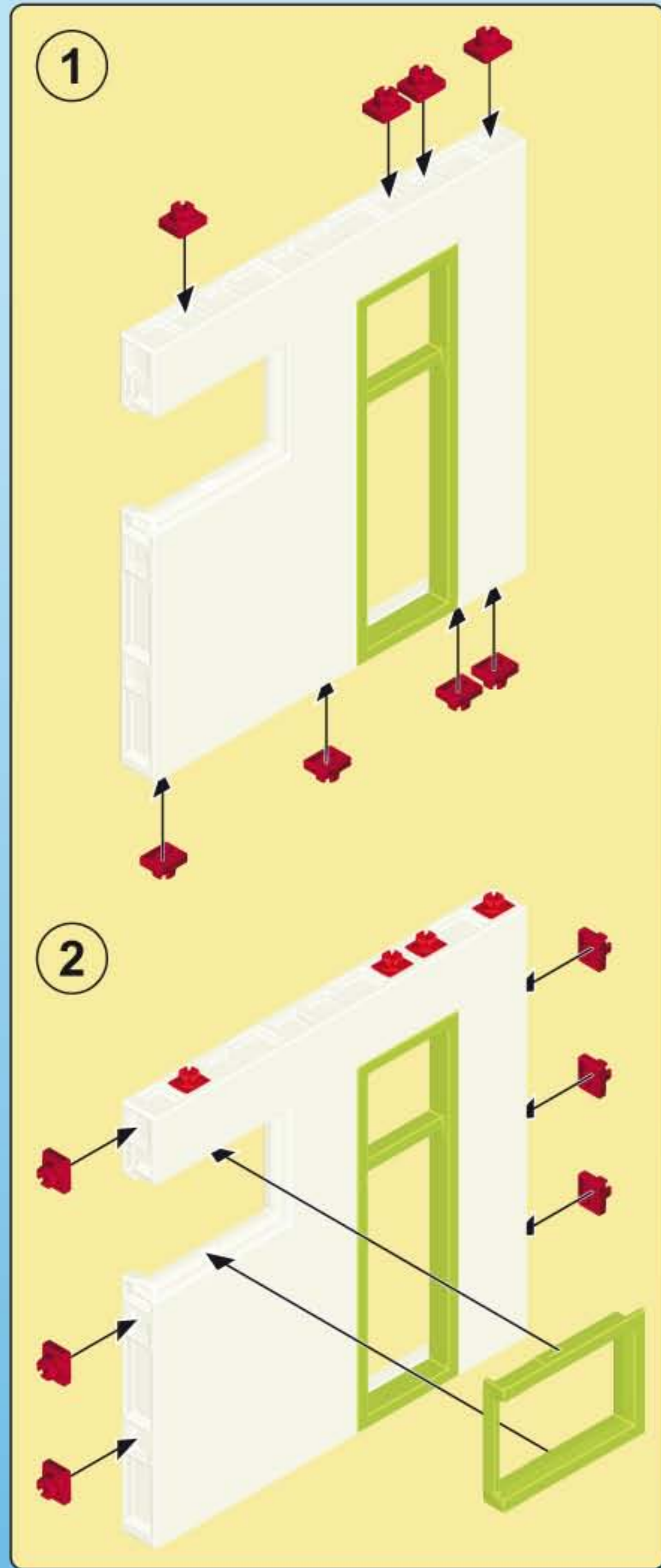

5

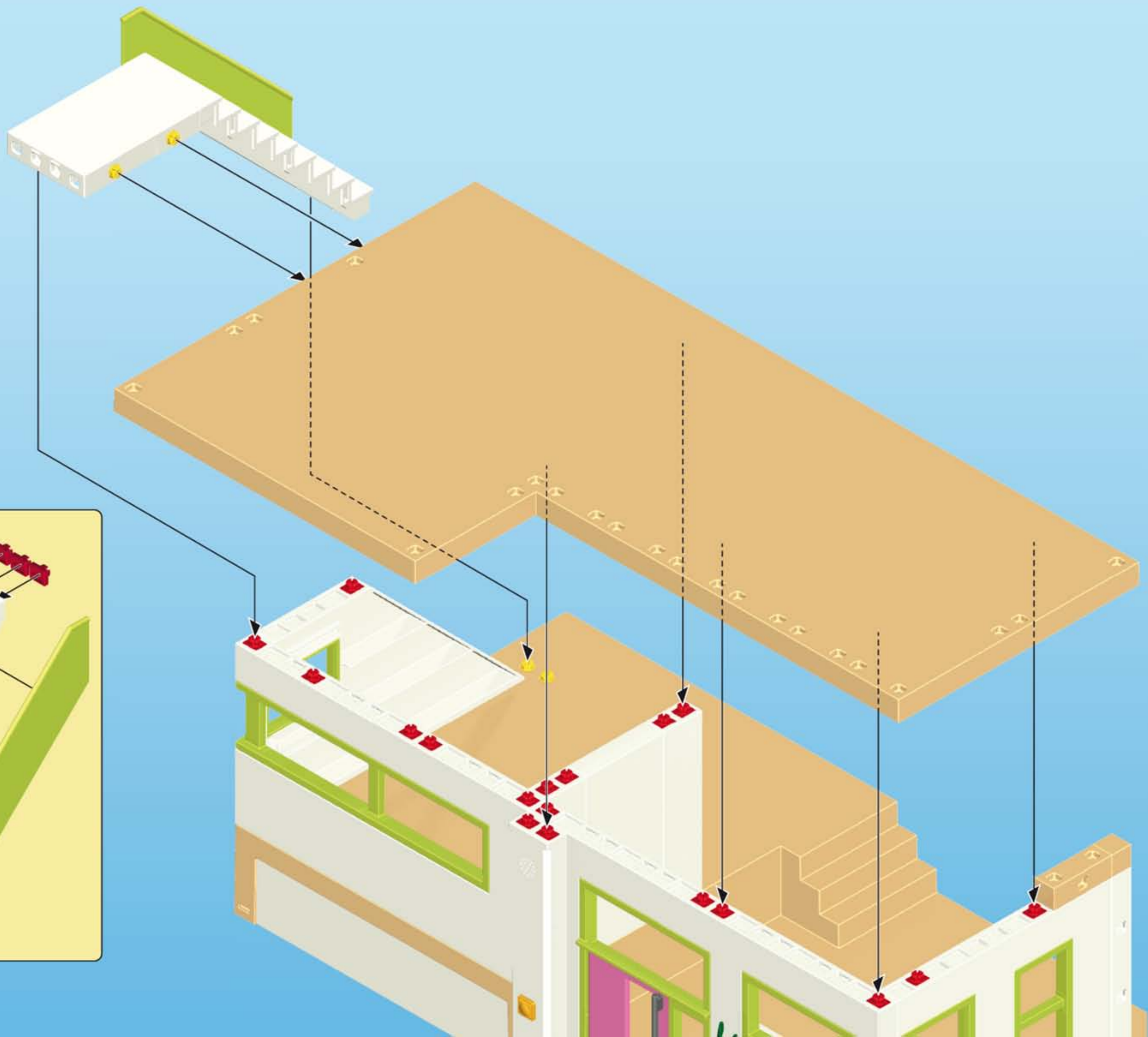
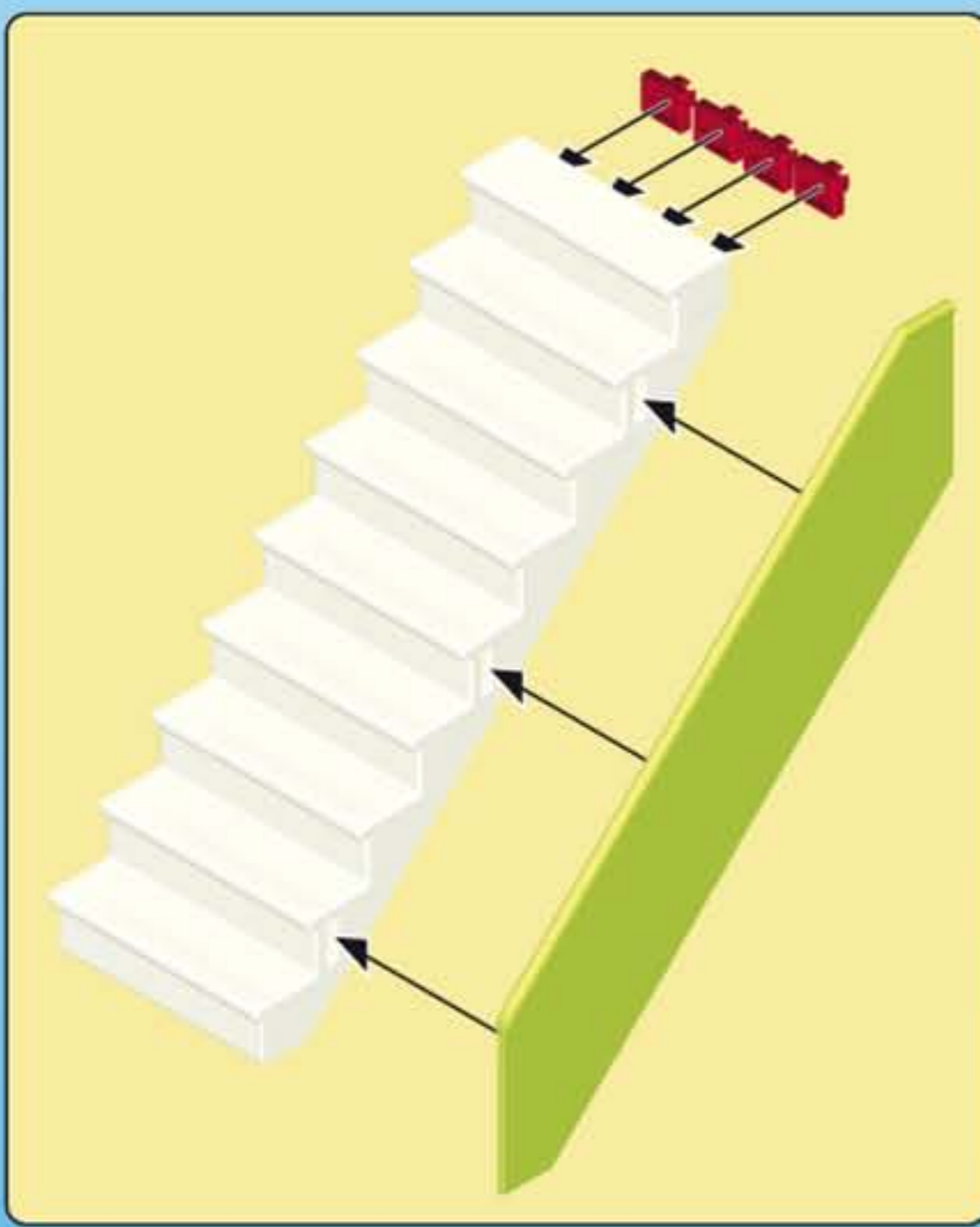
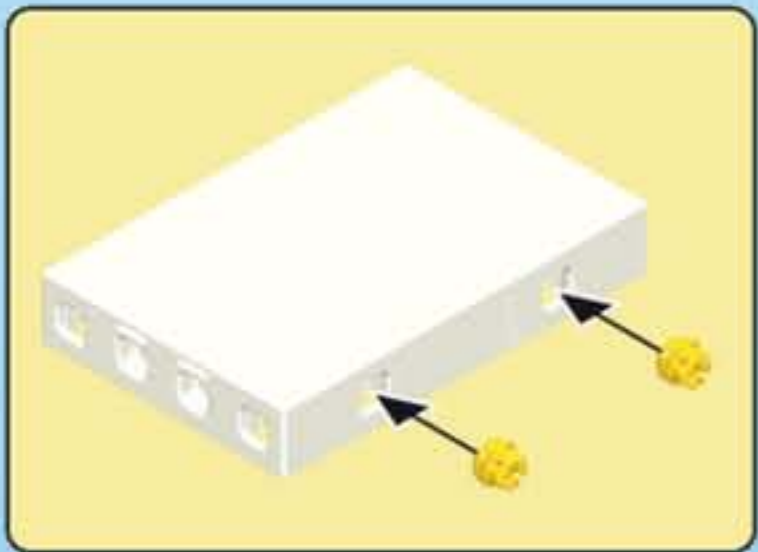

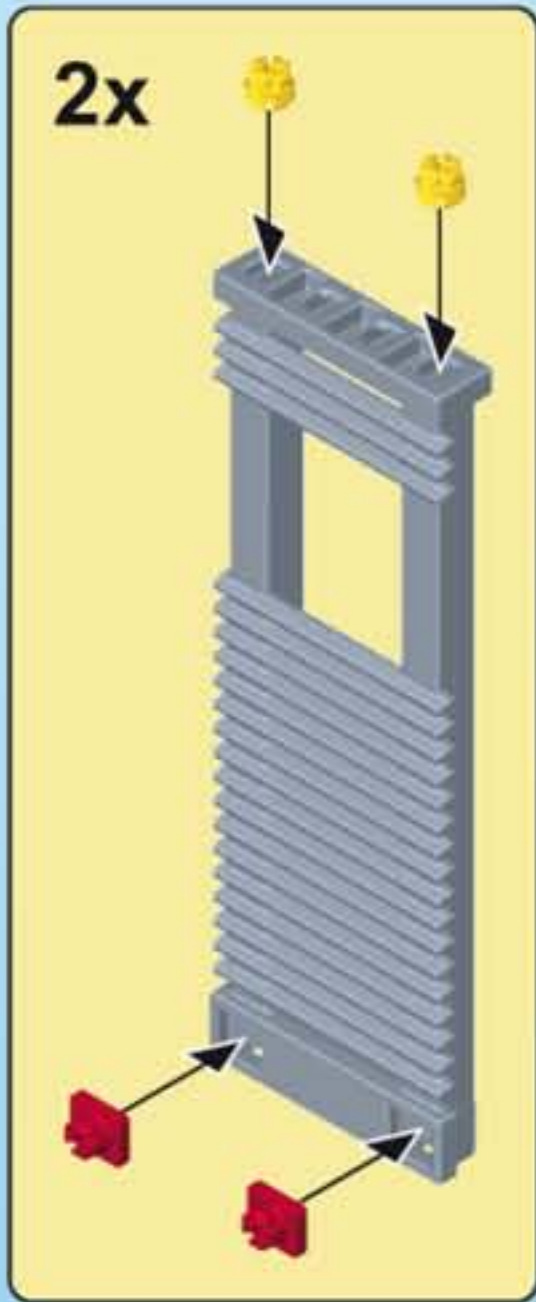

6

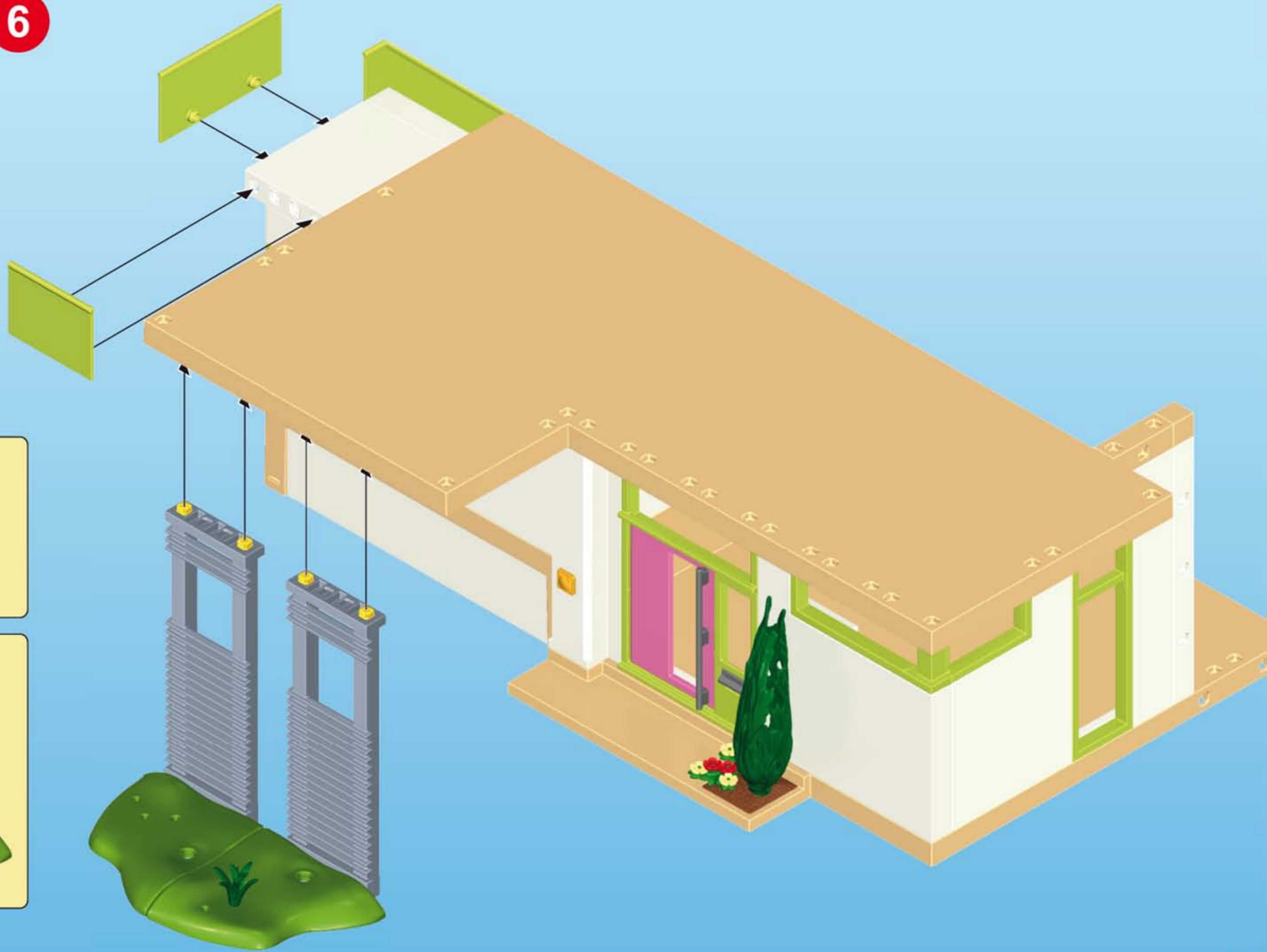
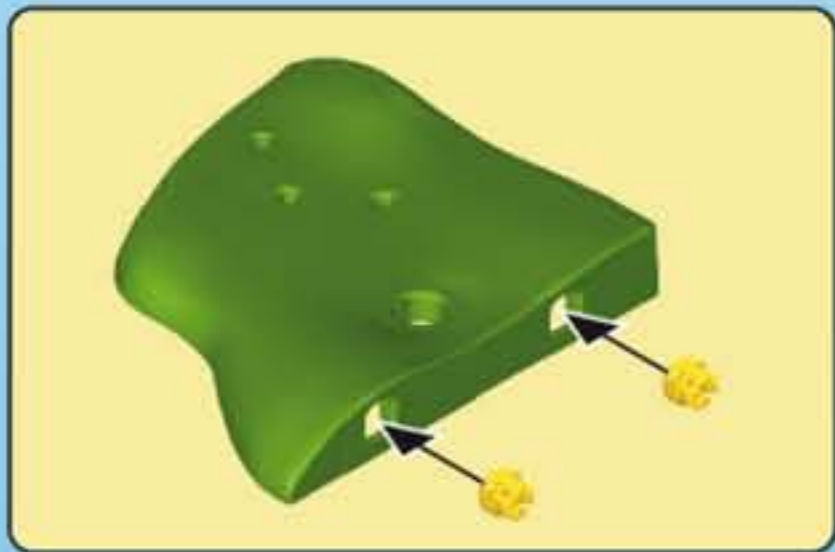

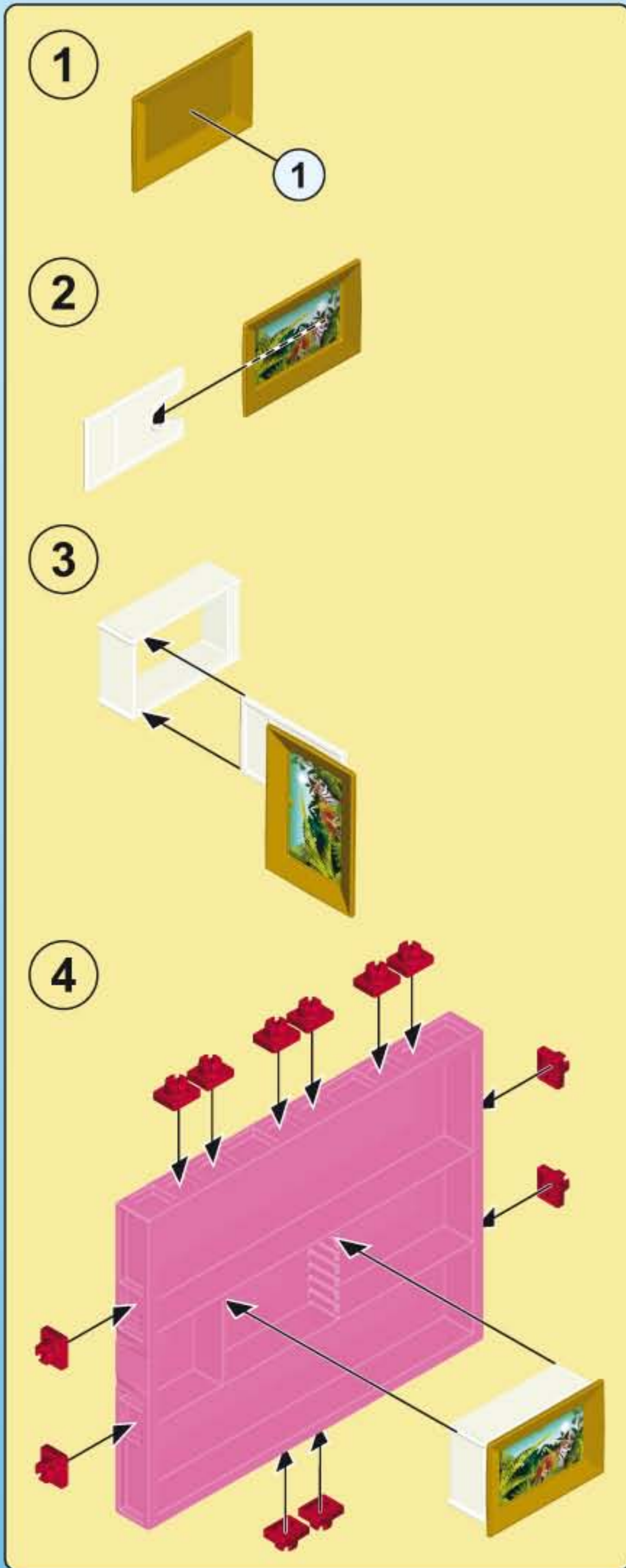

7

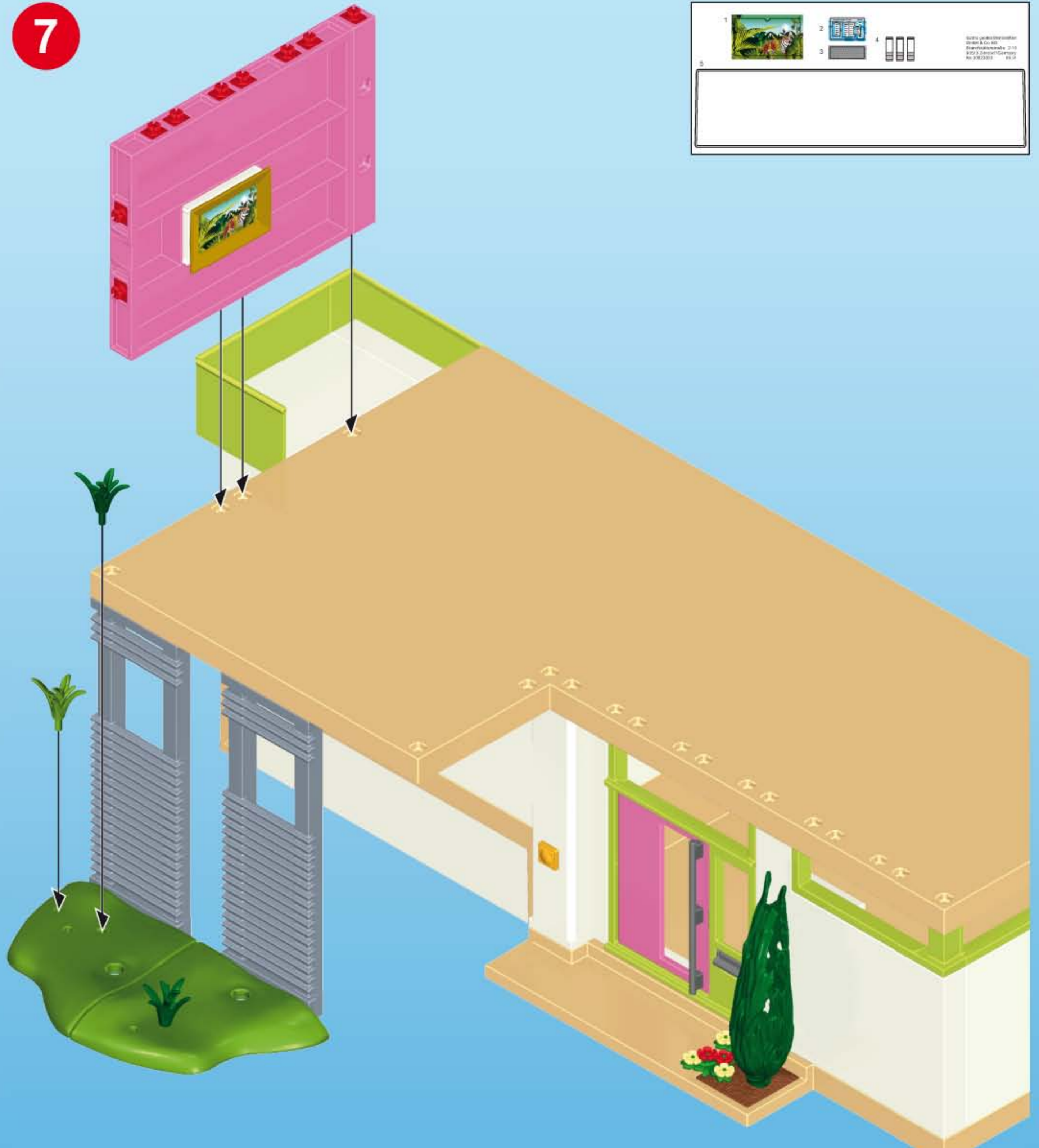

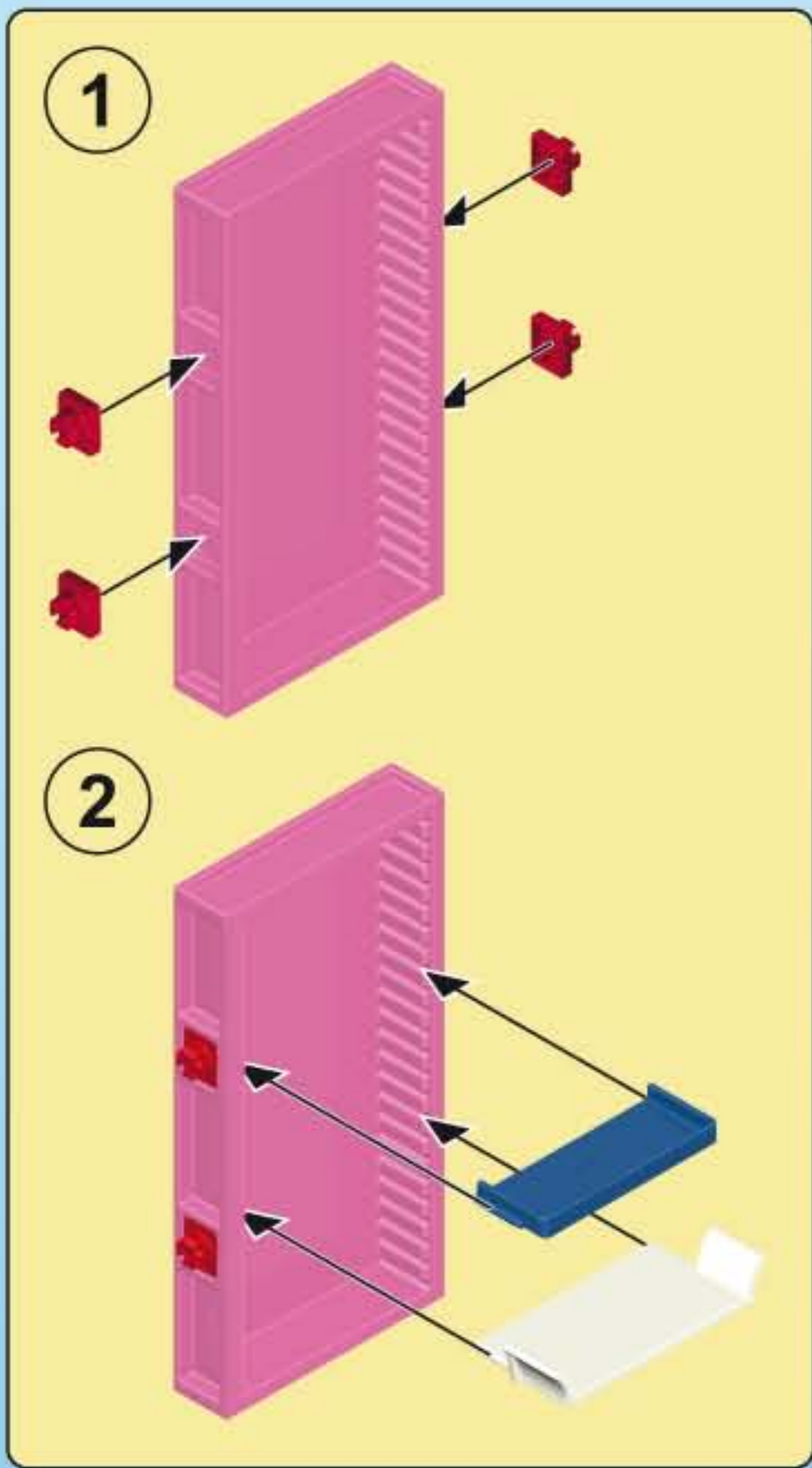

8

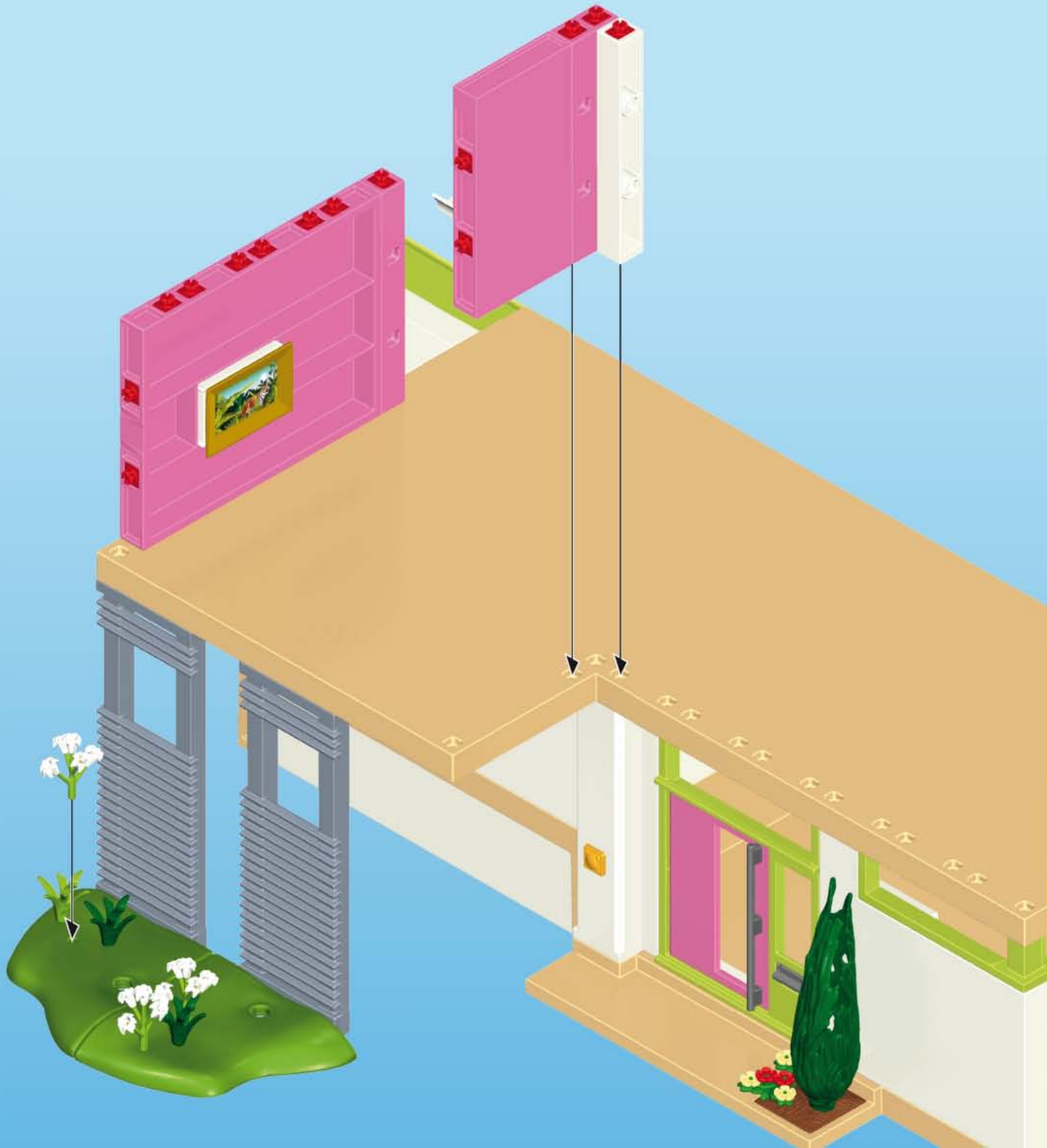
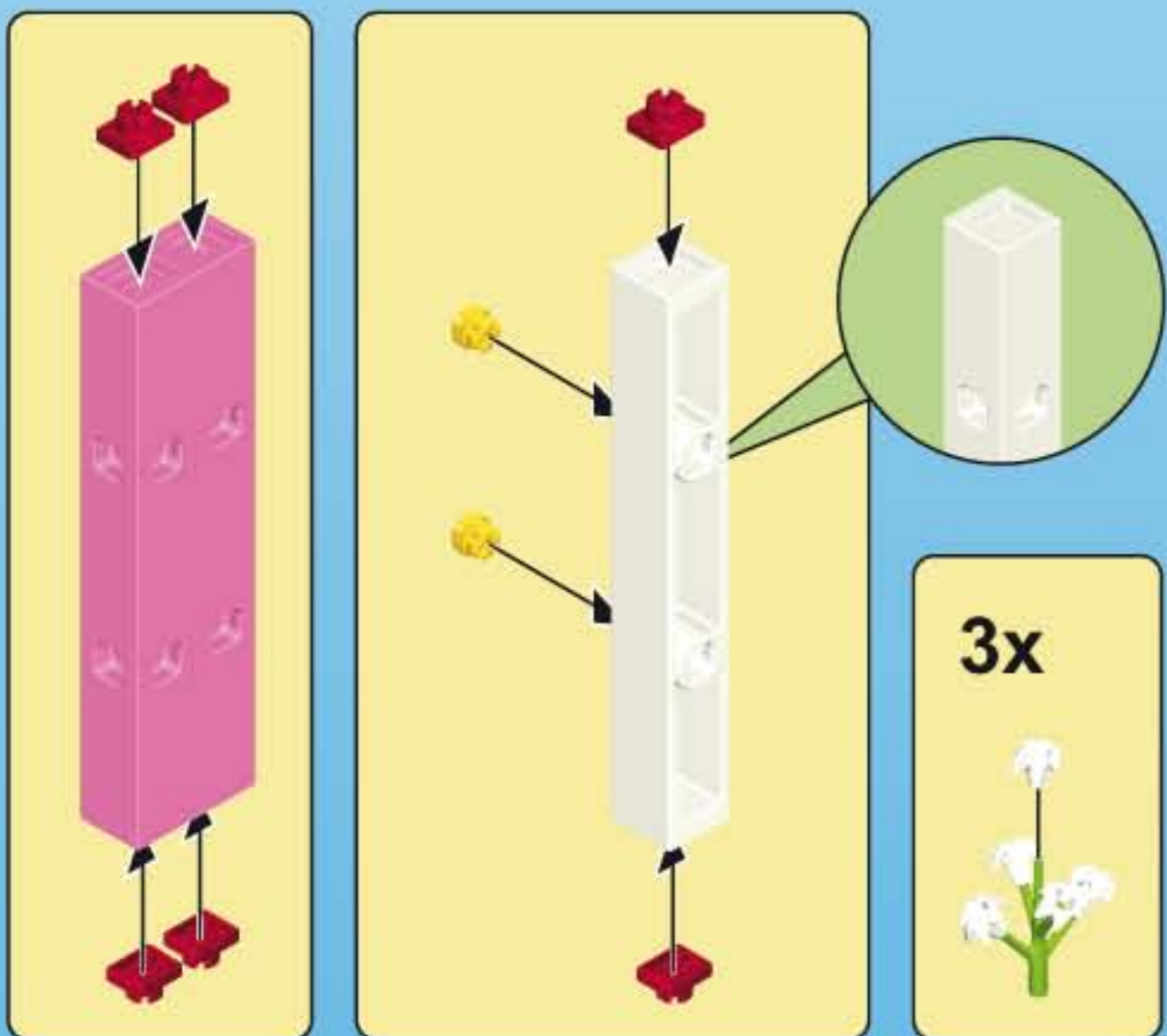

9

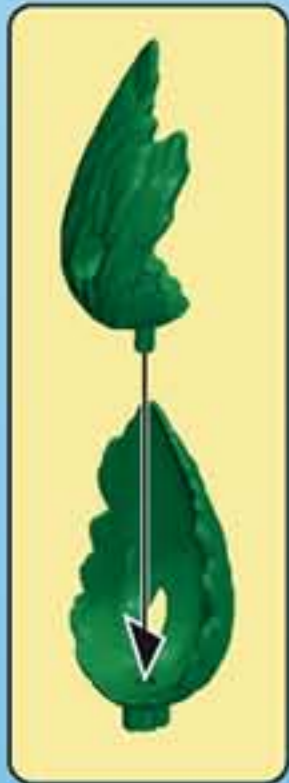
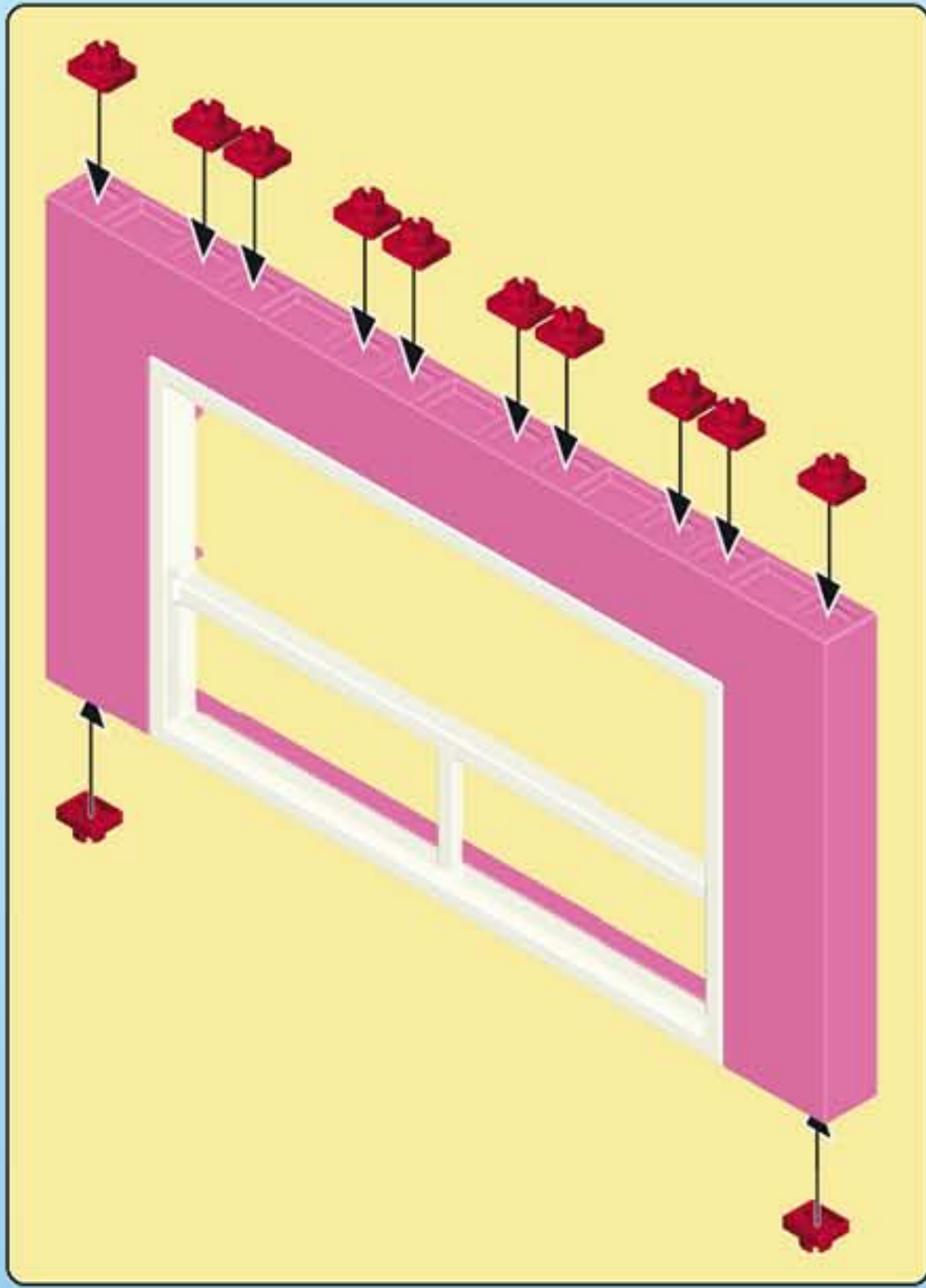

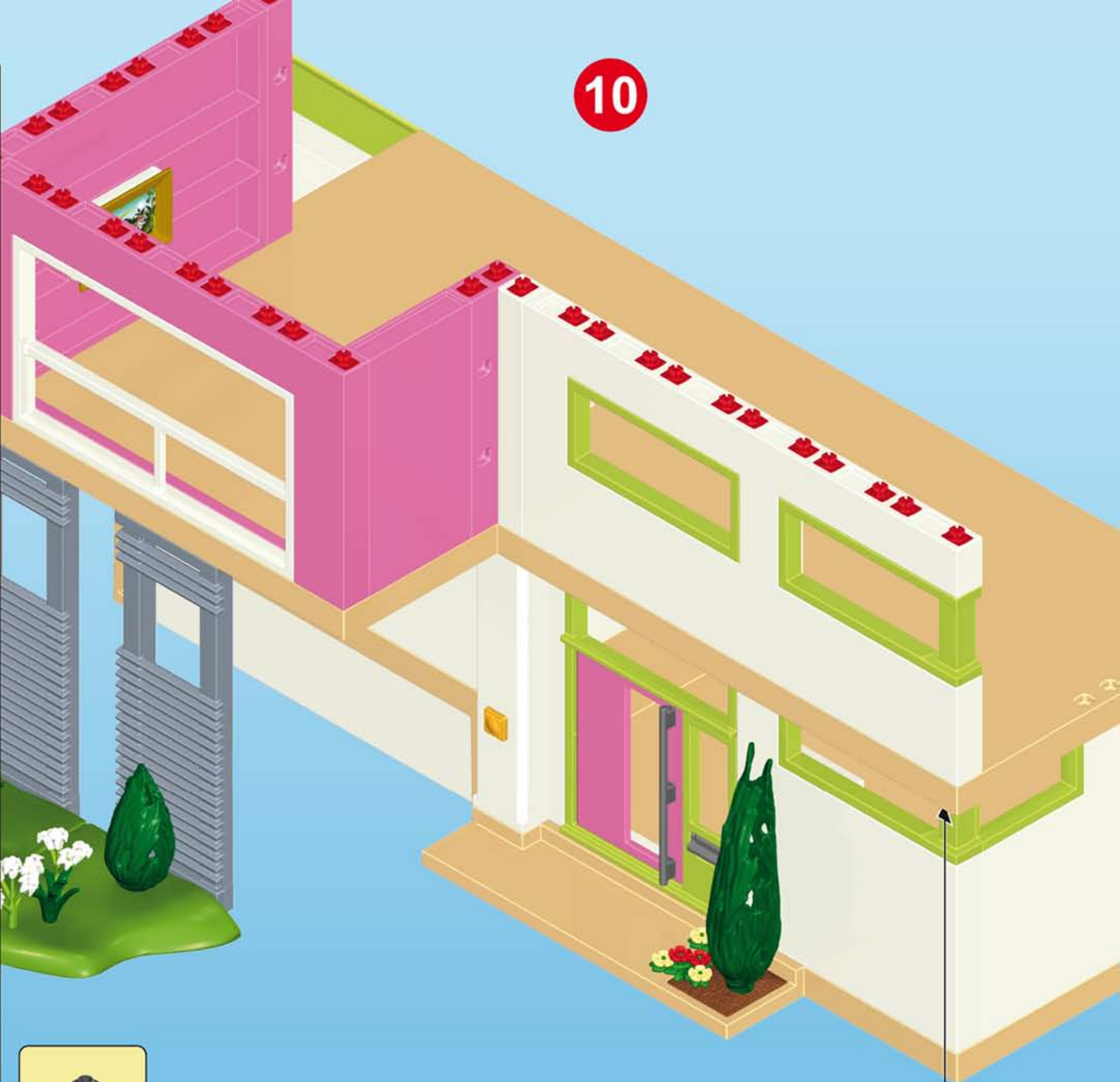
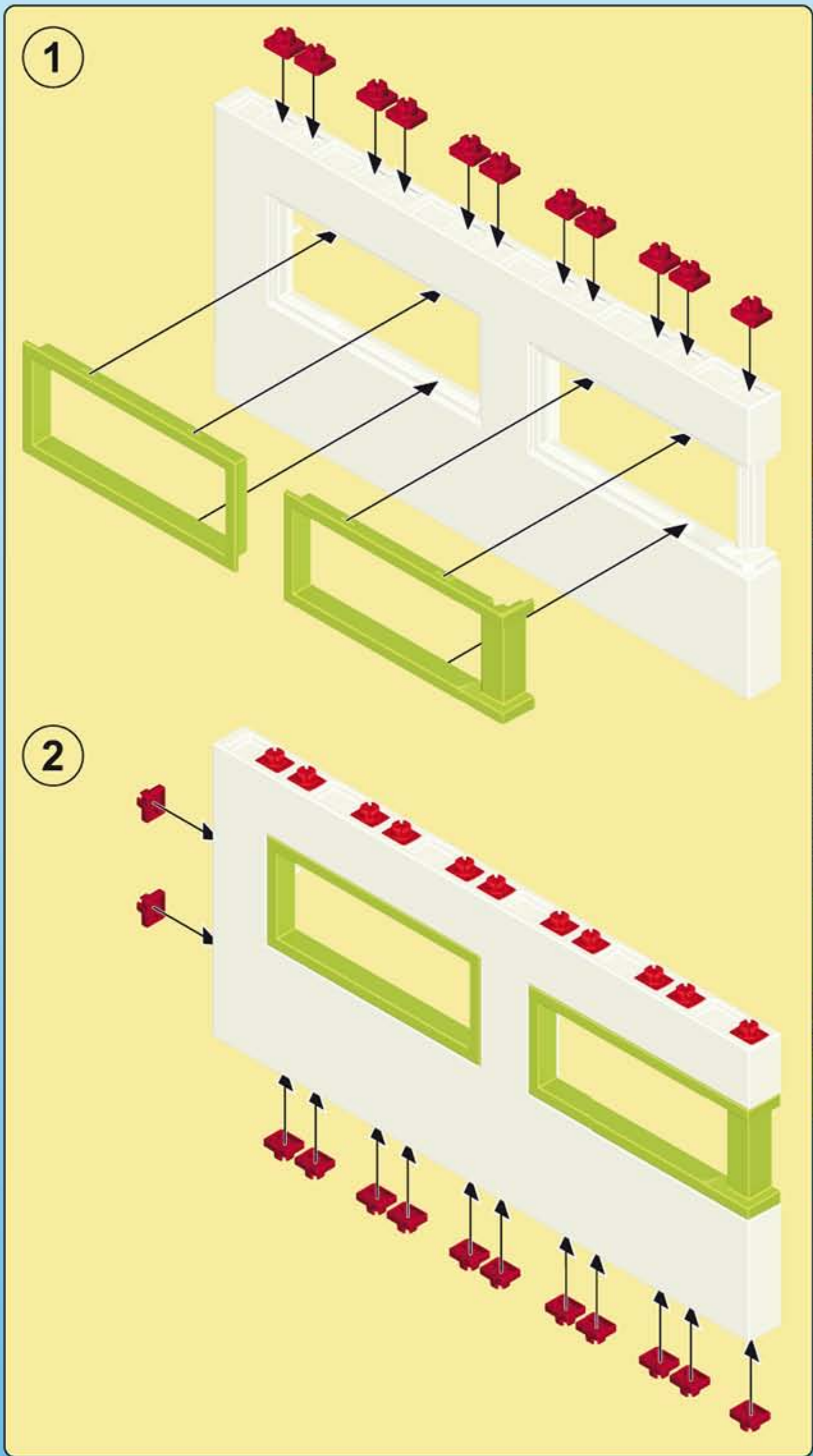

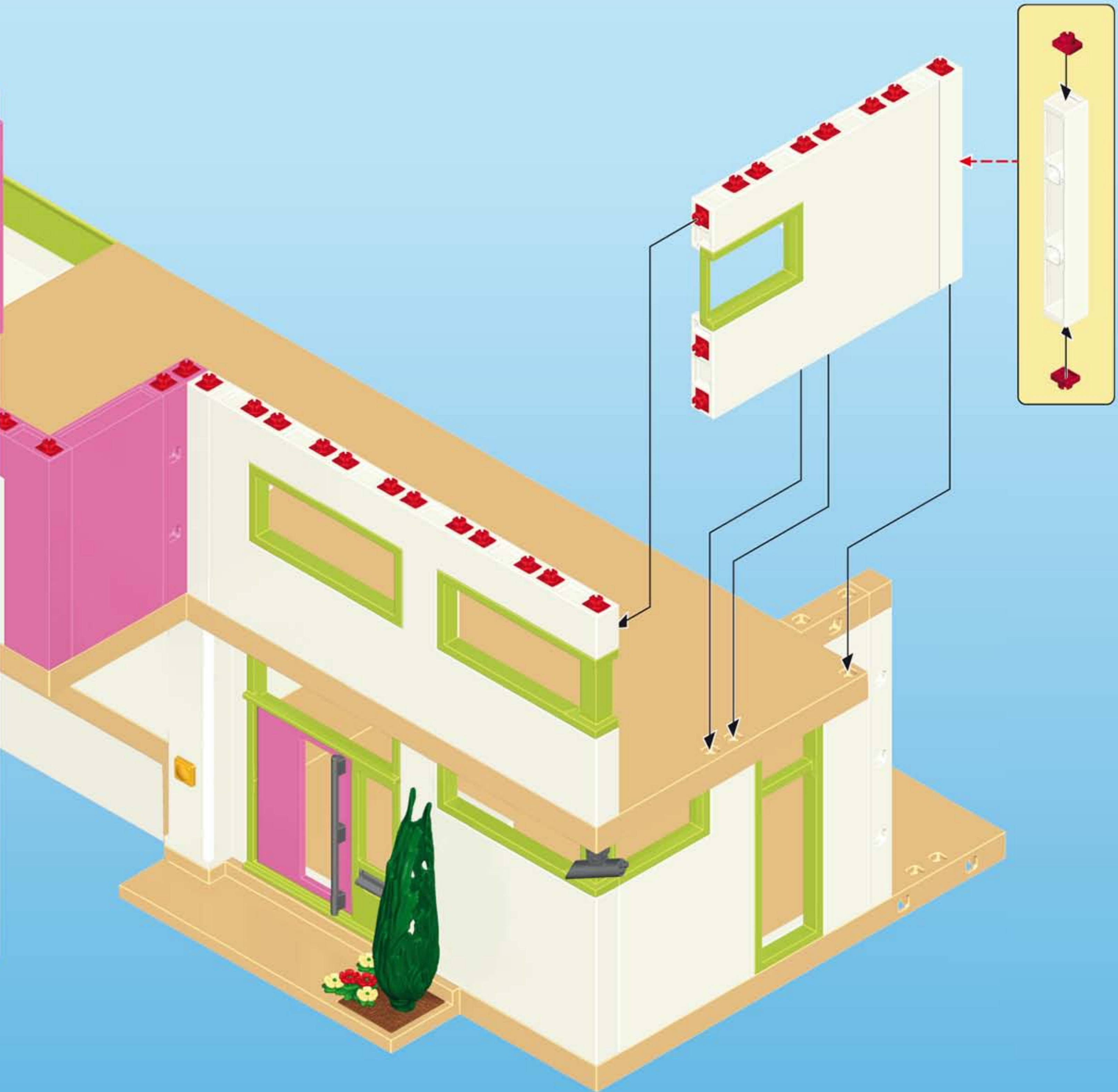
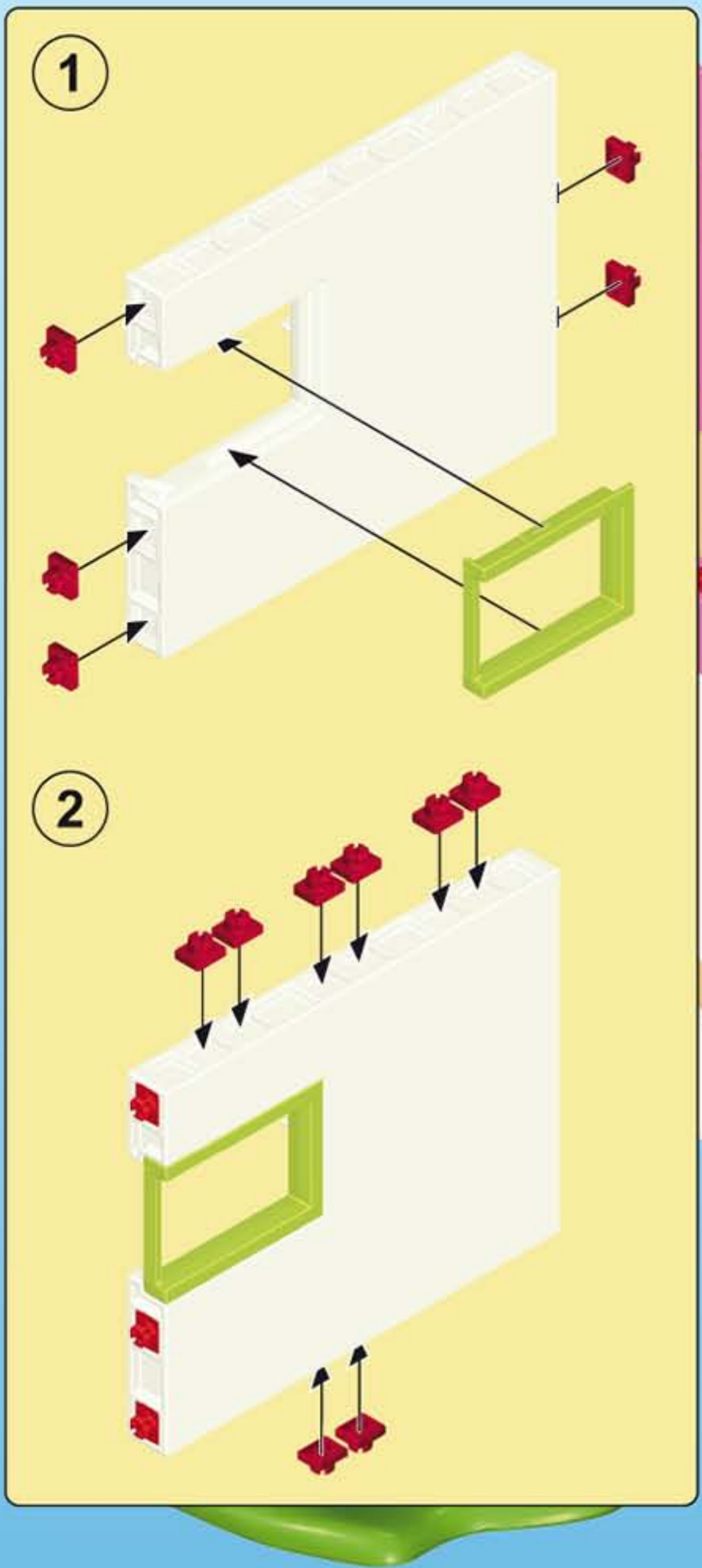

12

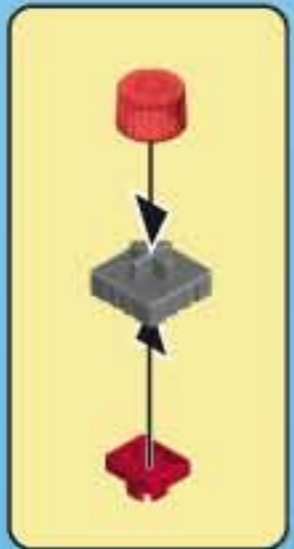
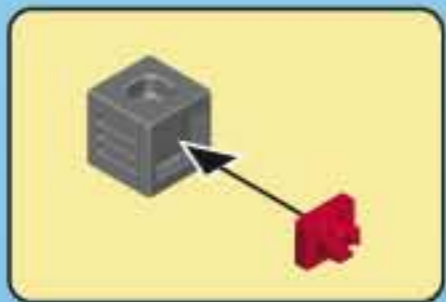
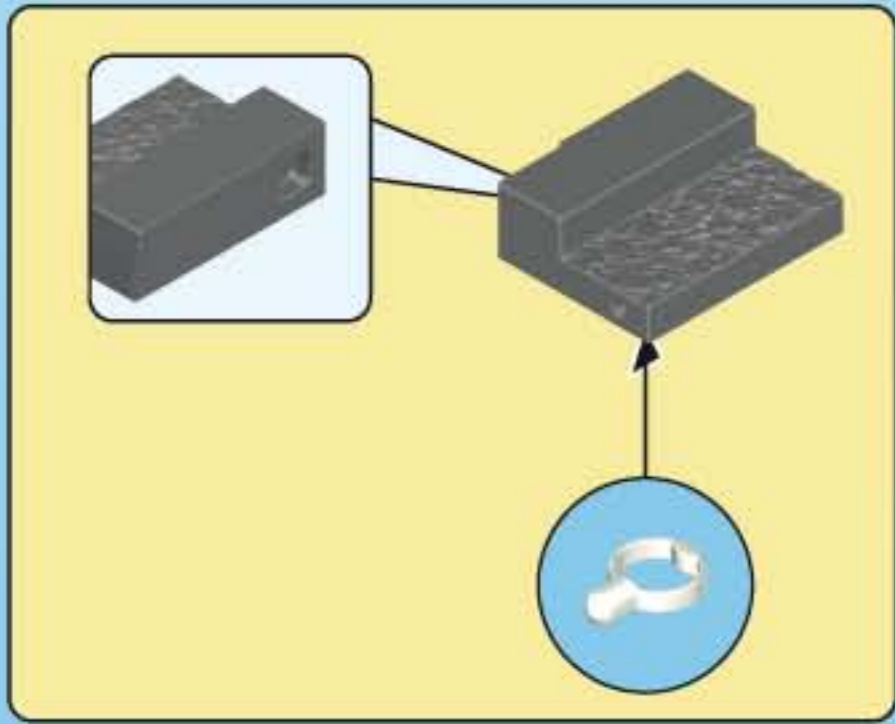
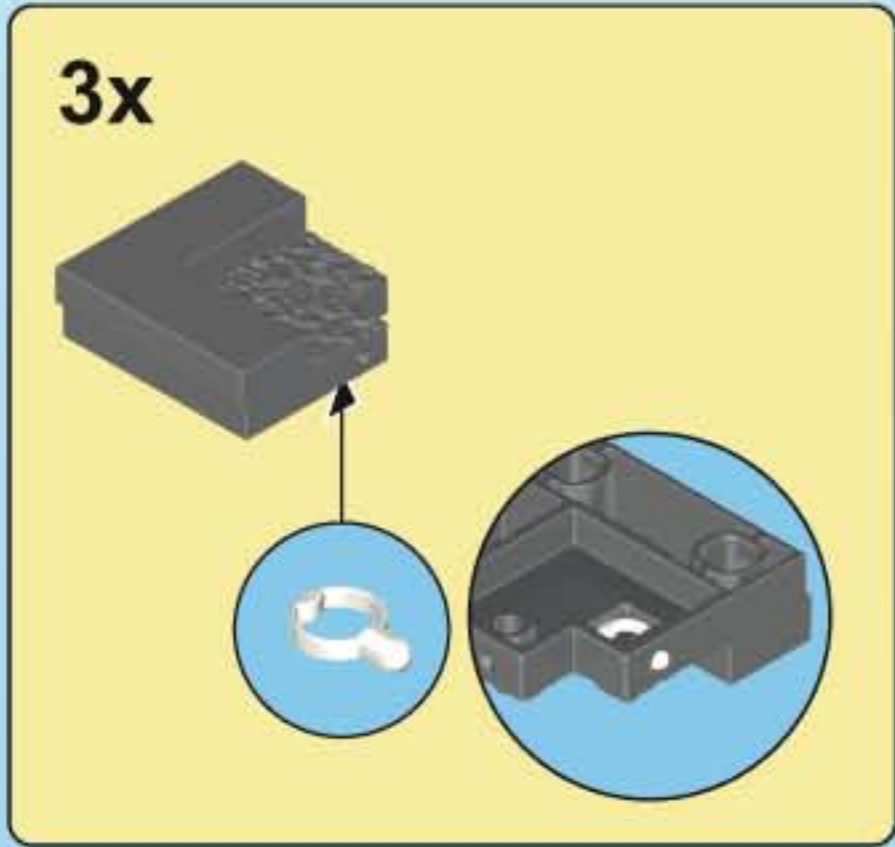

13

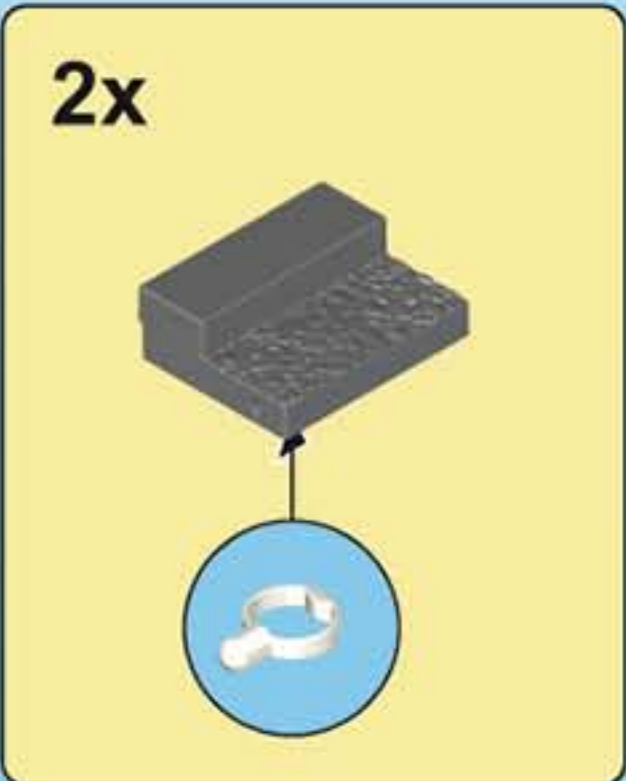
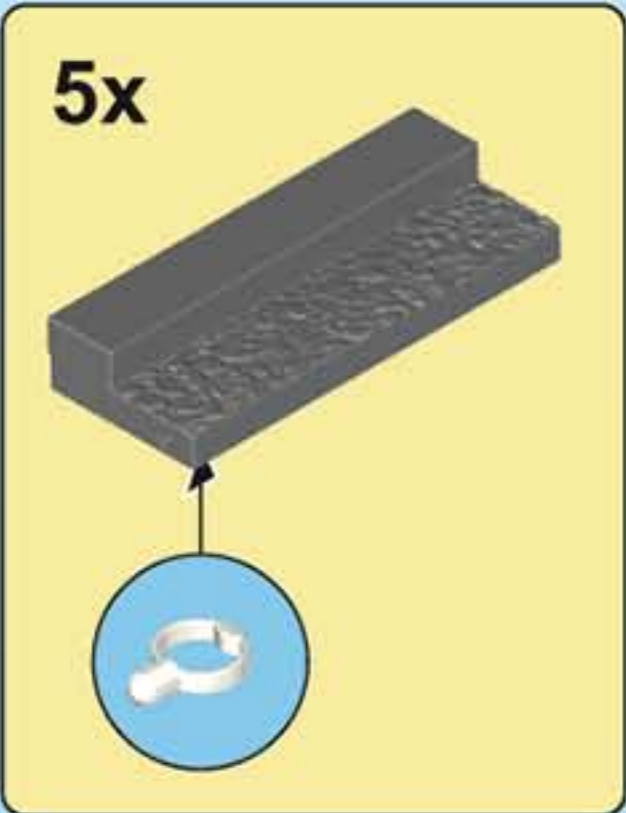

14

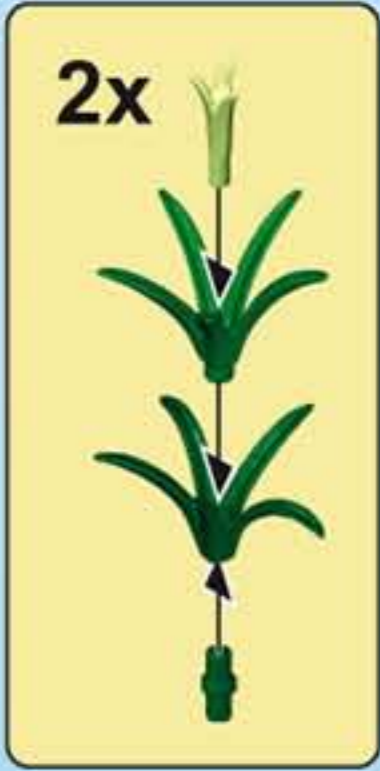



1

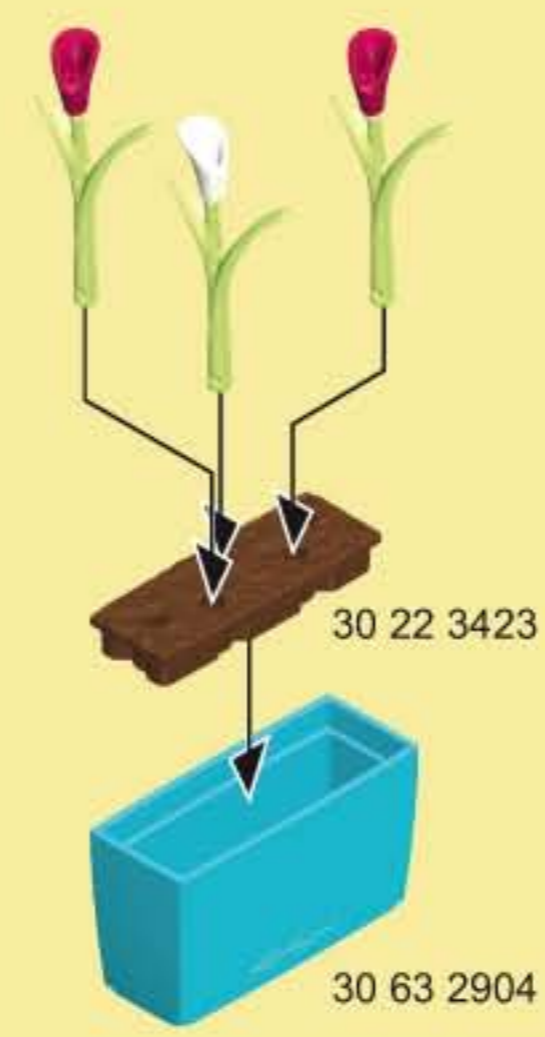
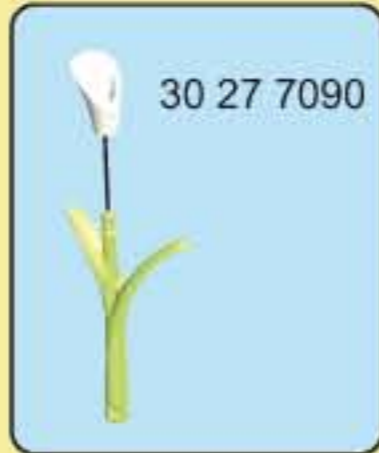

2

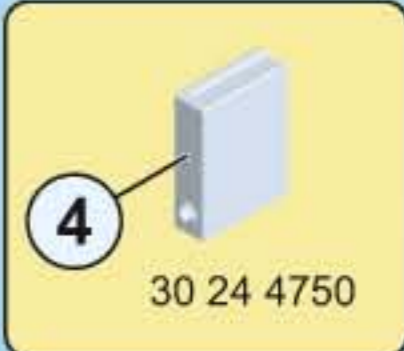
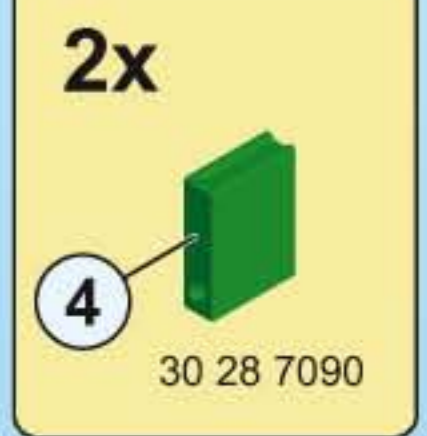
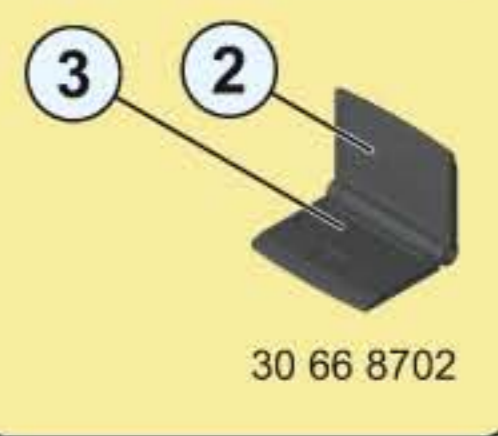
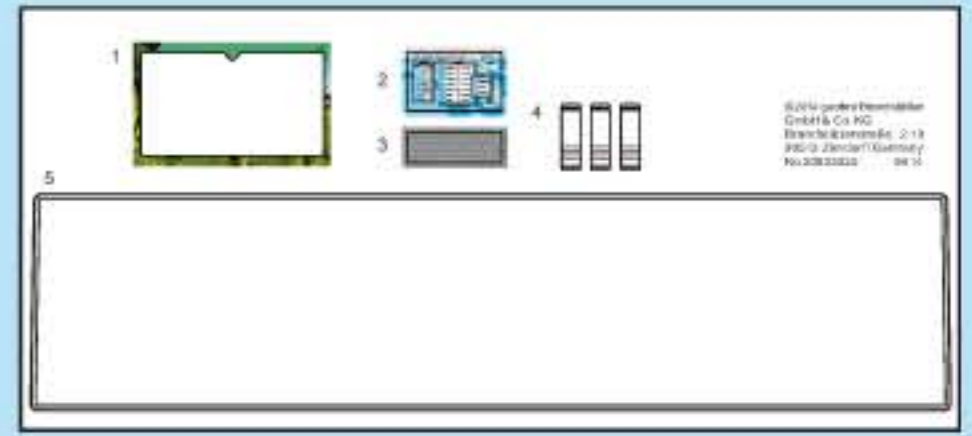

1



2

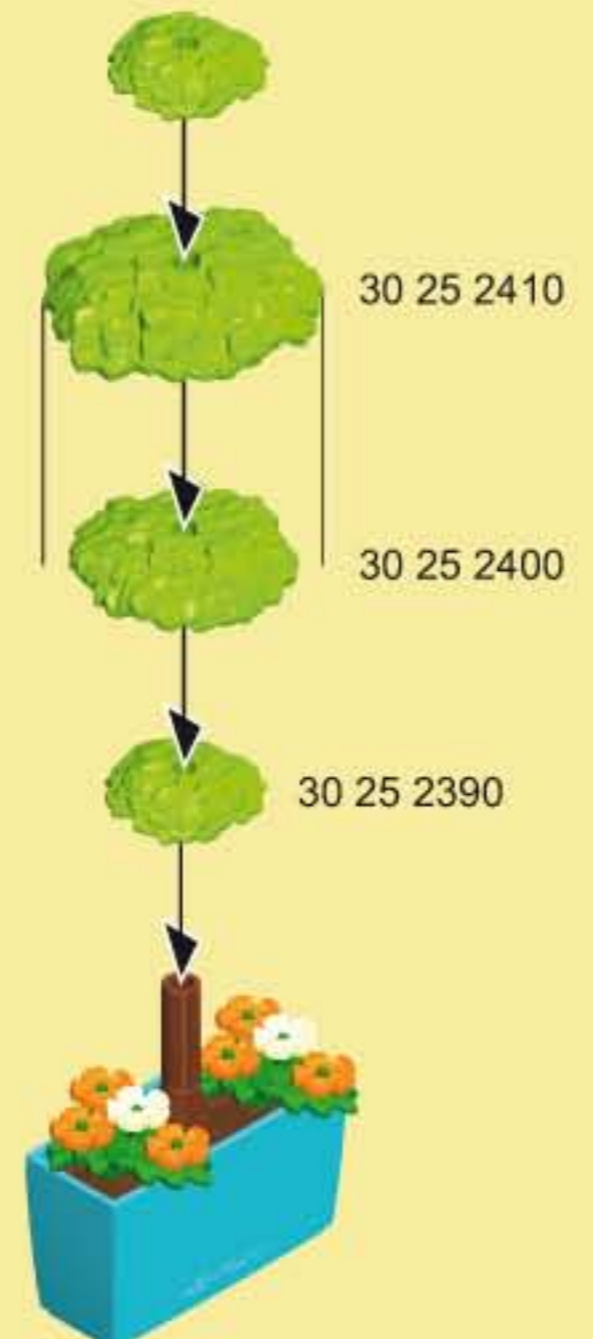

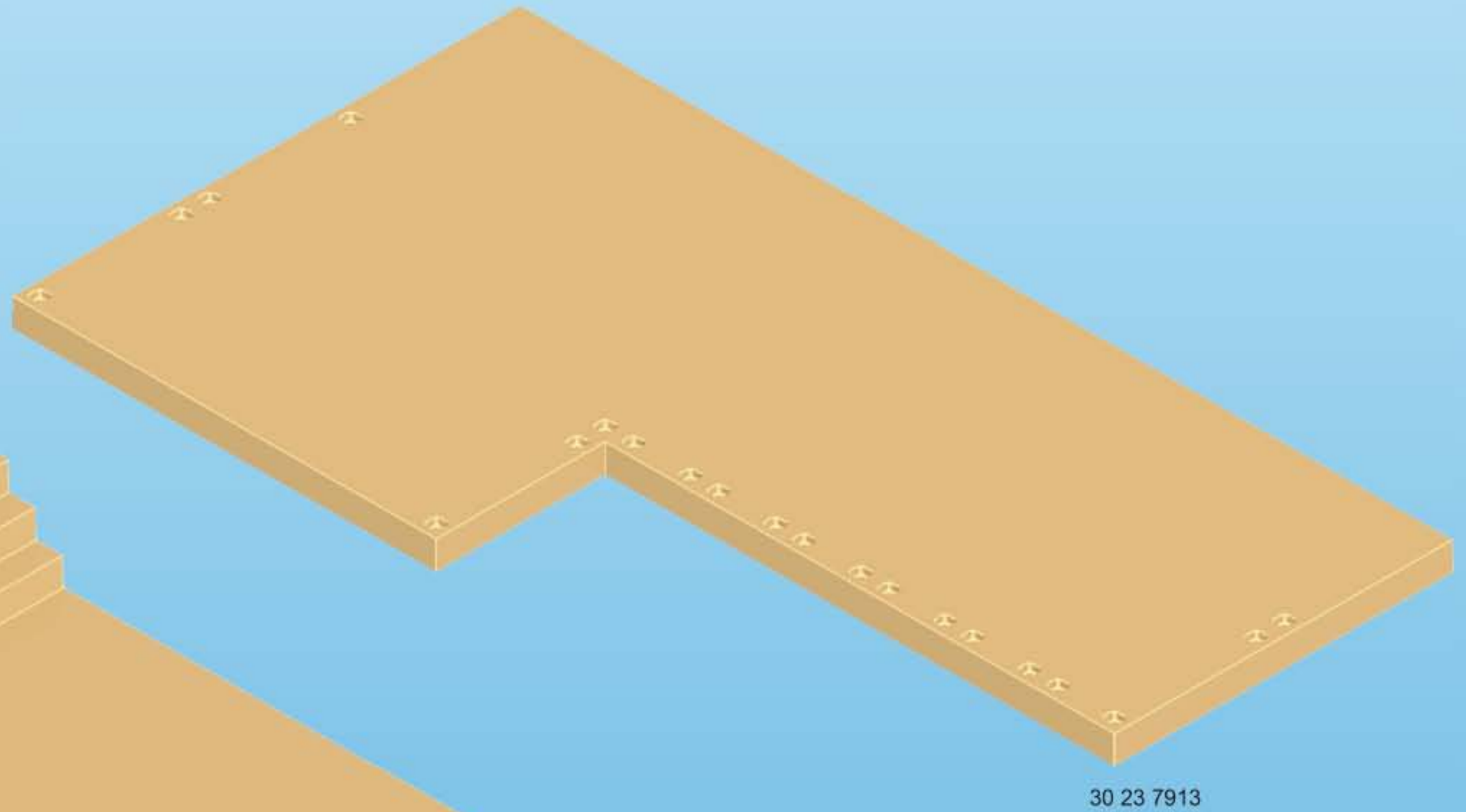
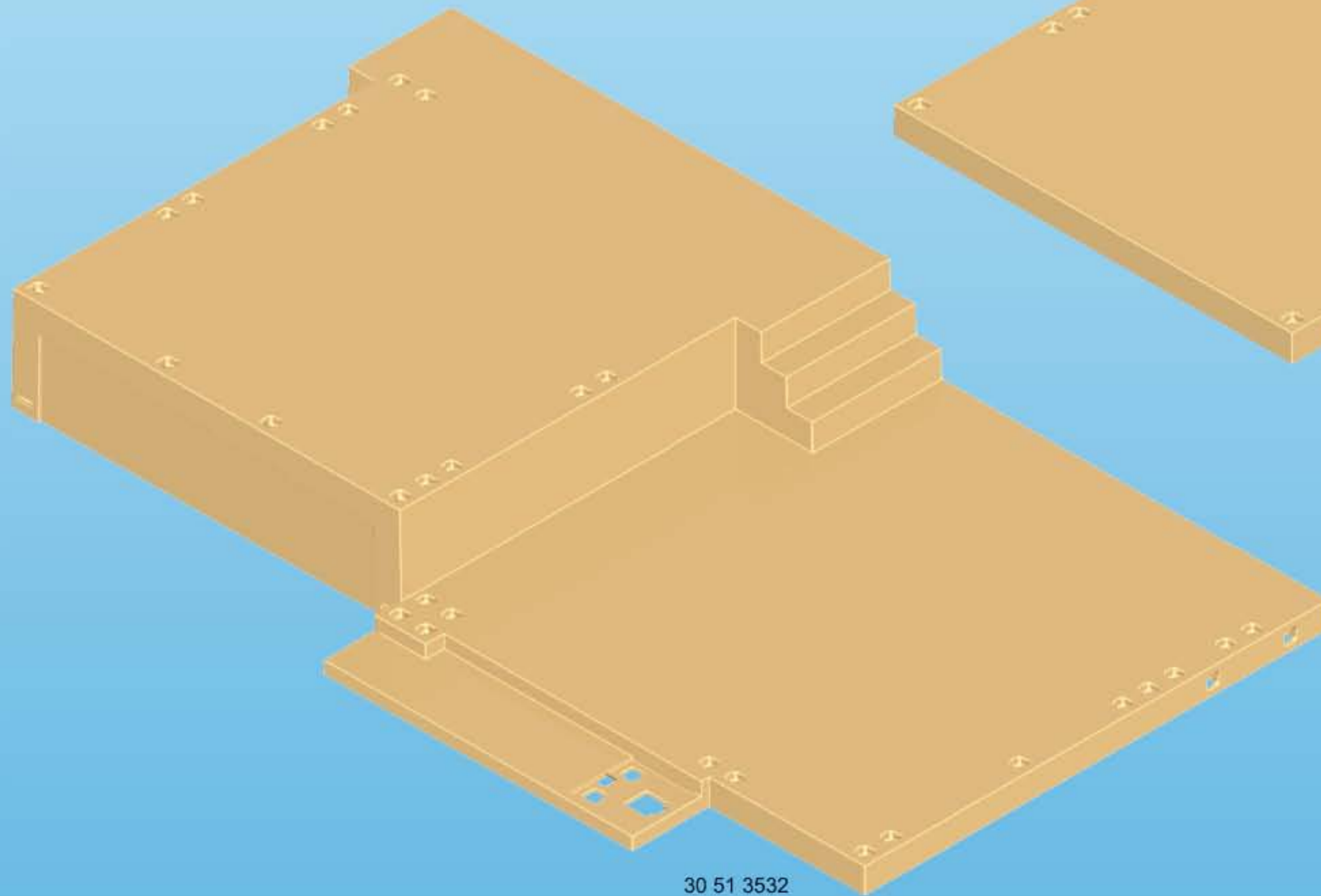
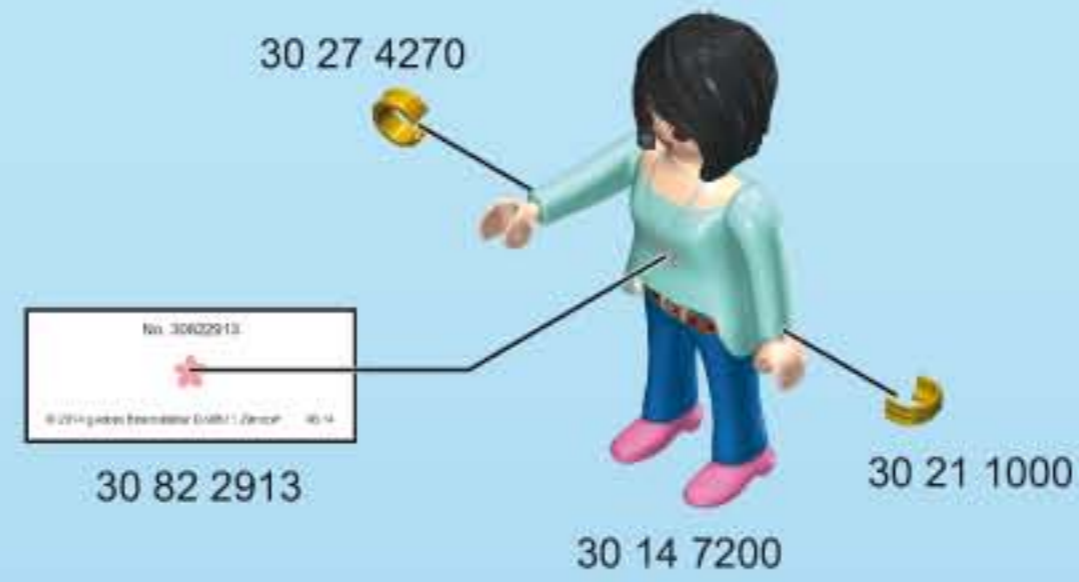



30 67 3862



30 67 3852

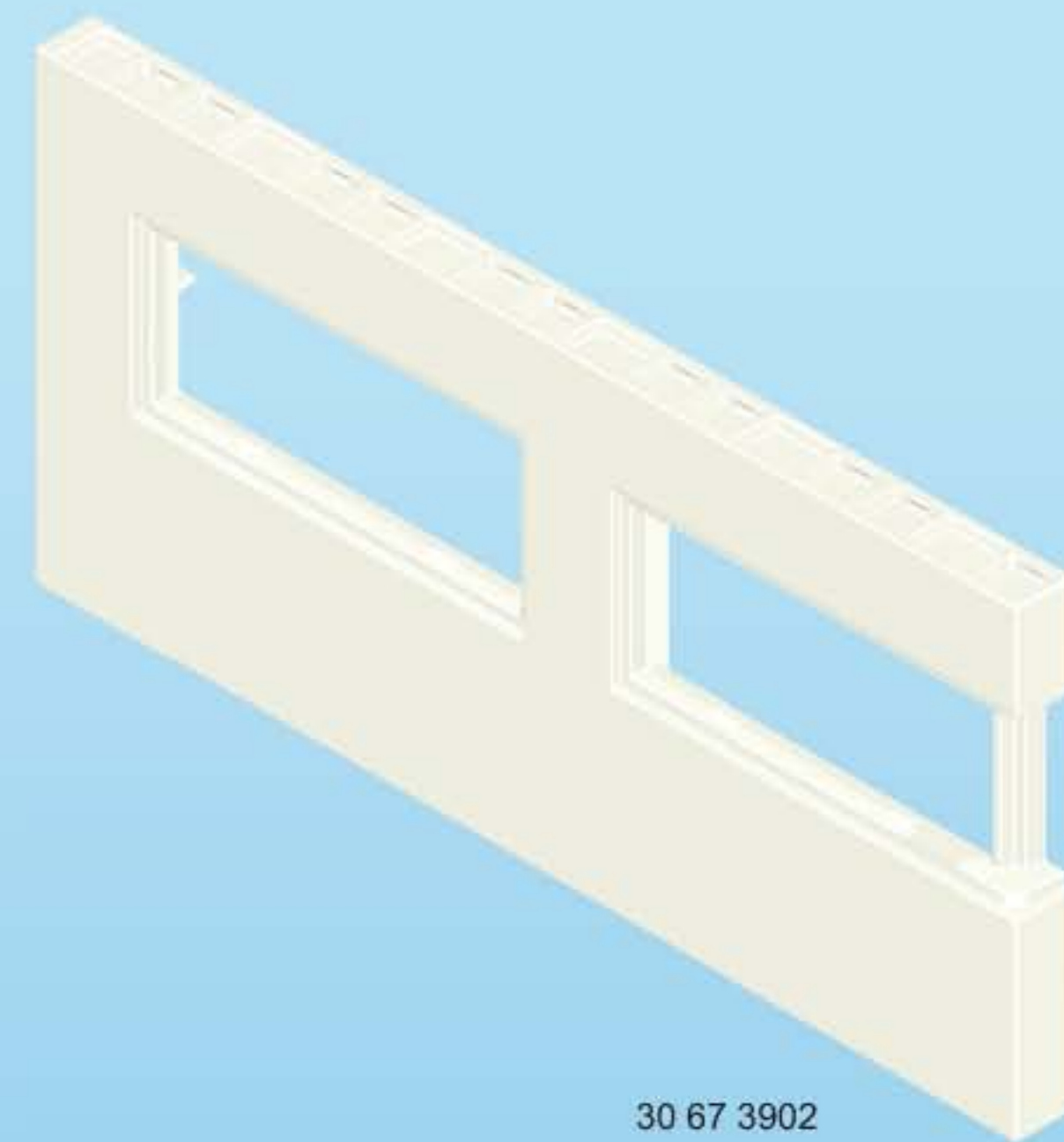

30 67 3902

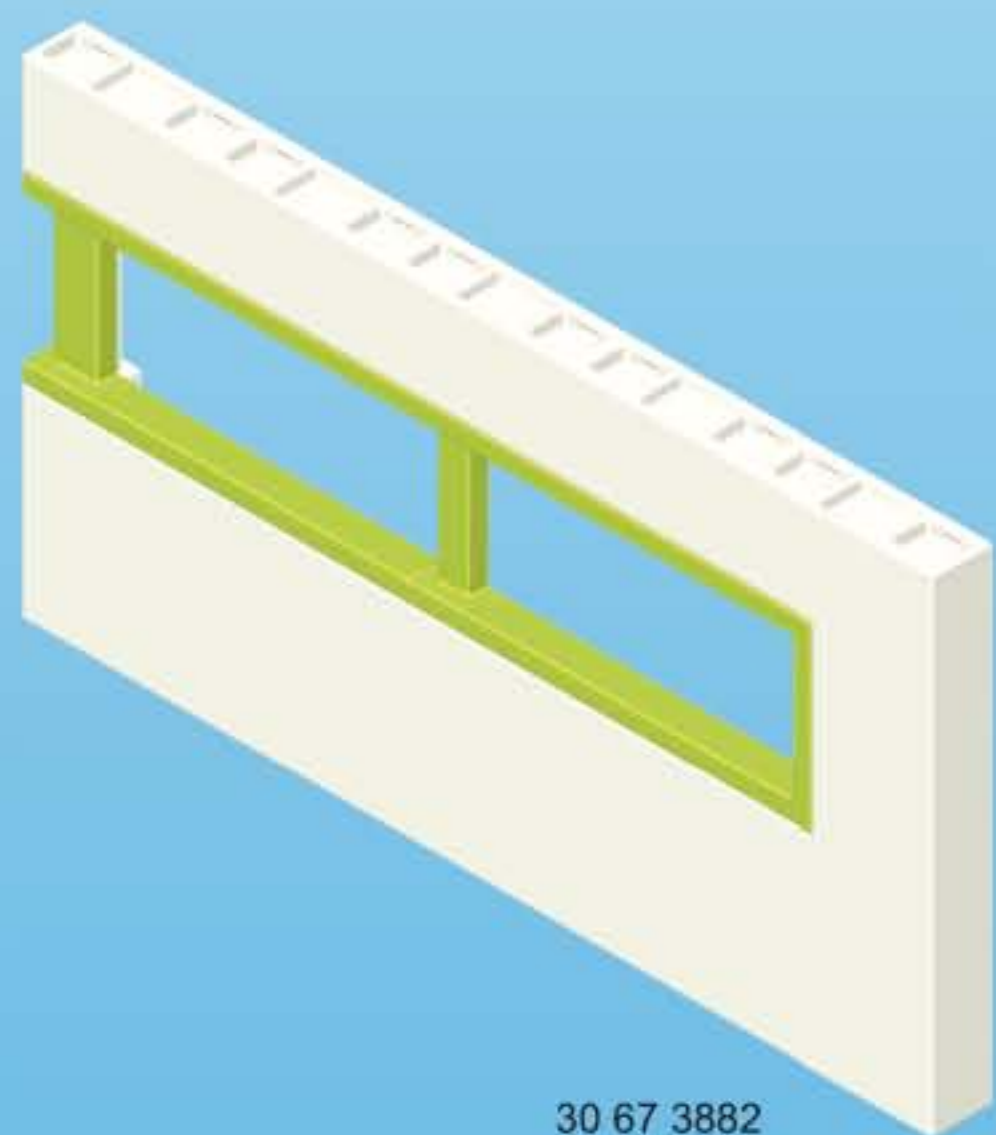

30 67 3882

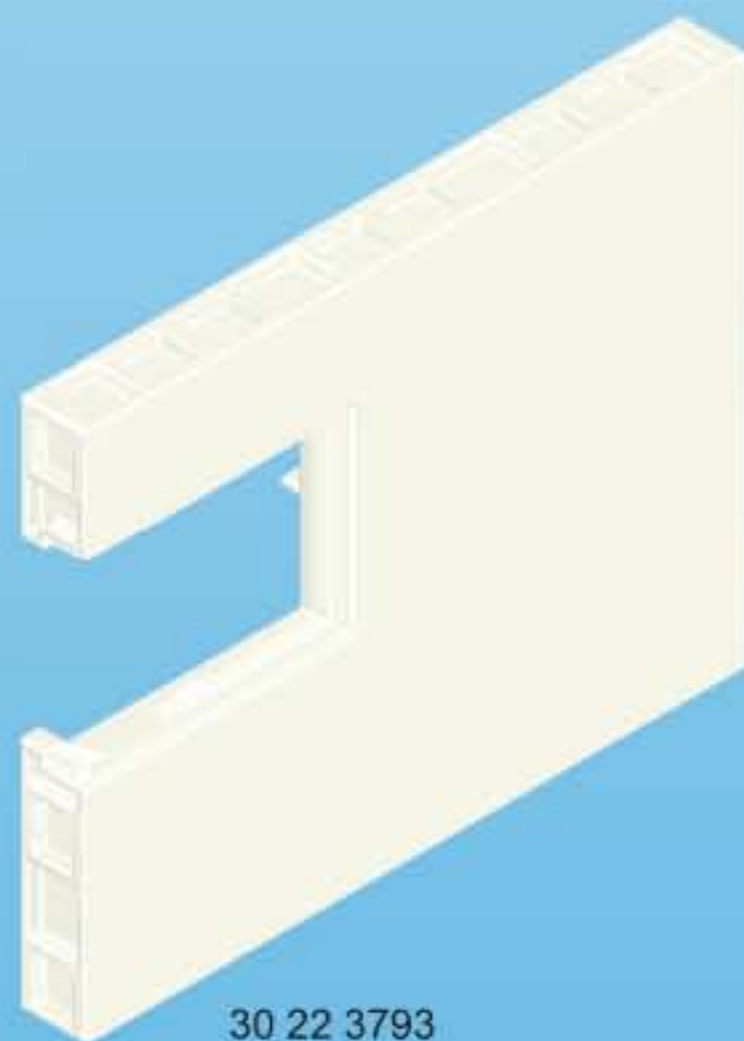

30 22 3793

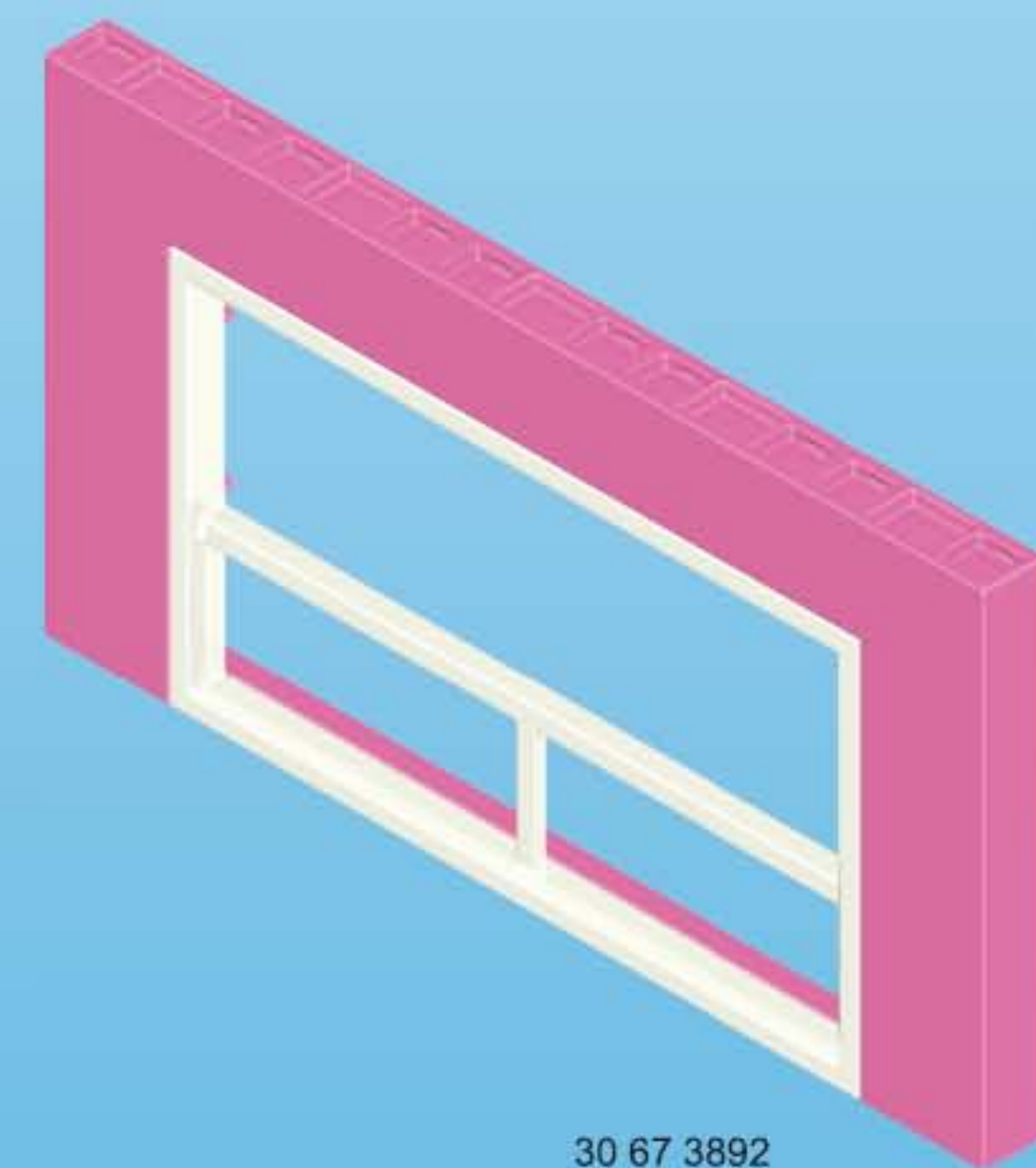

30 67 3892

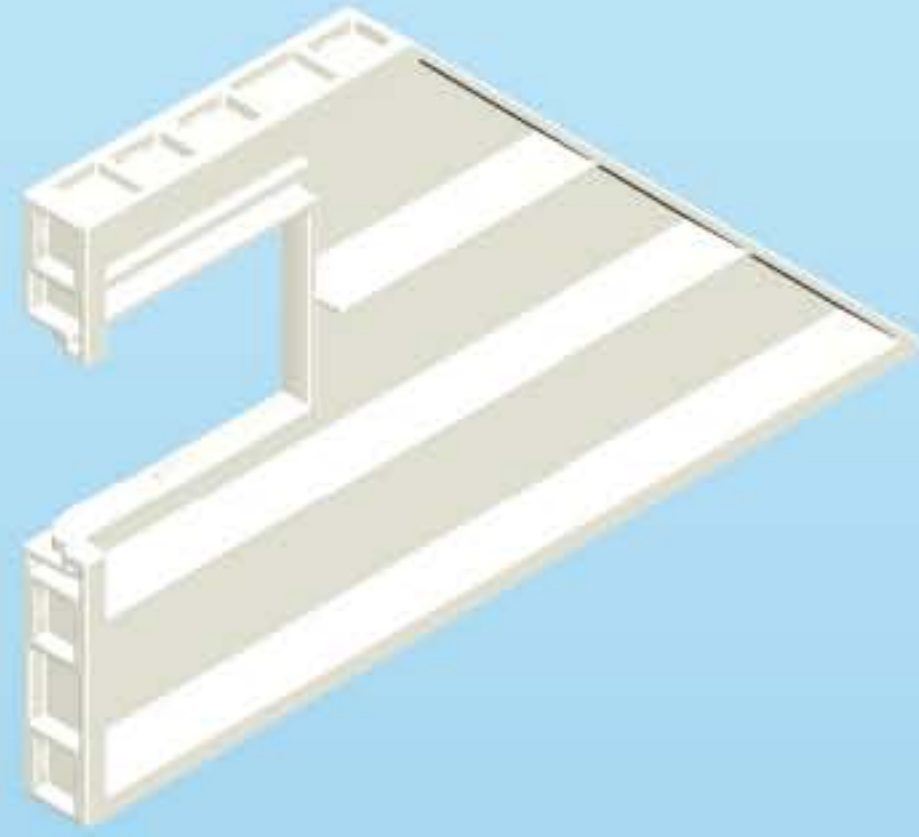

30 22 3753

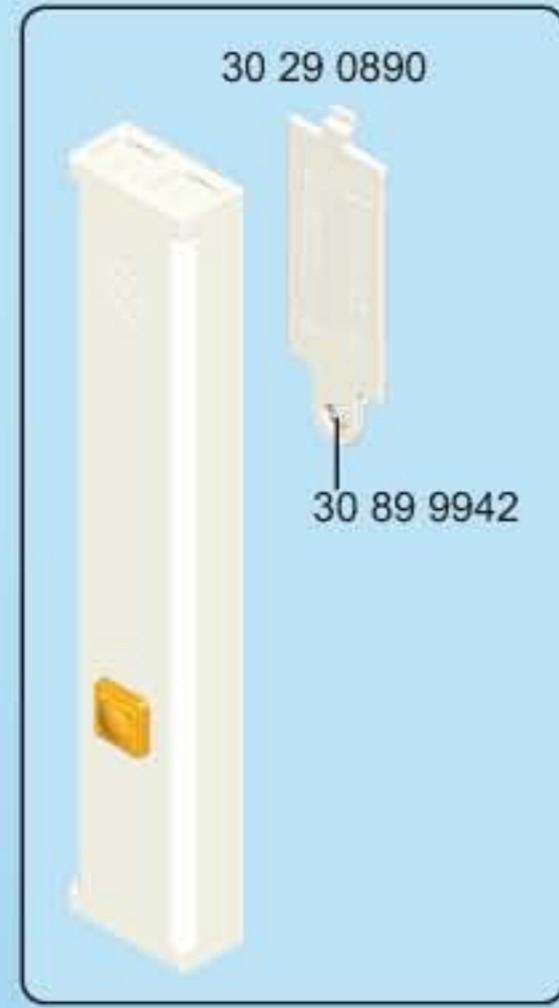

30 65 5392

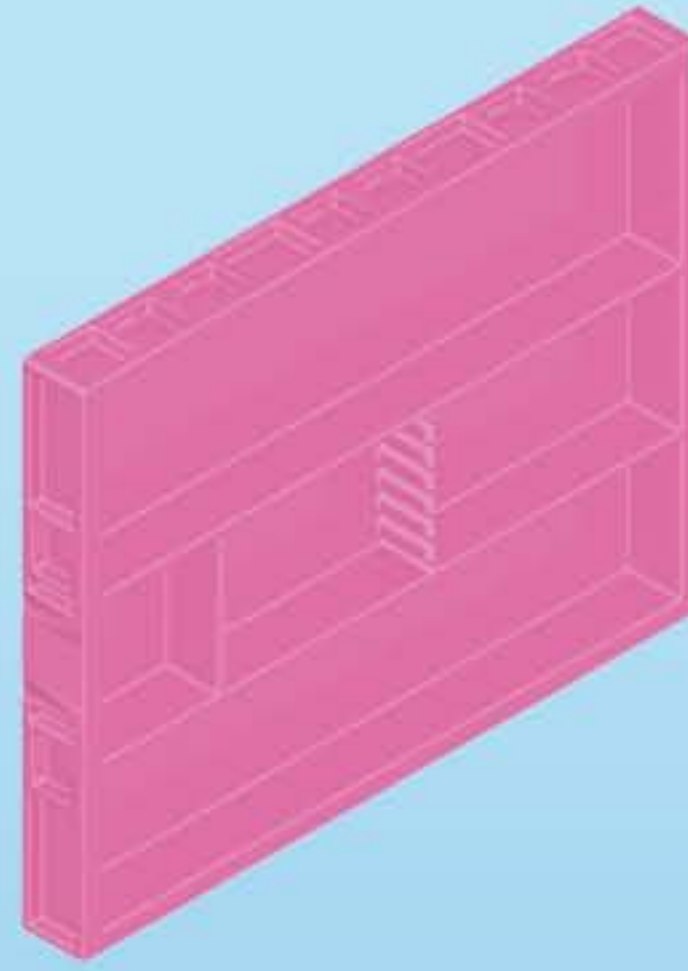

30 22 3783



30 21 8942

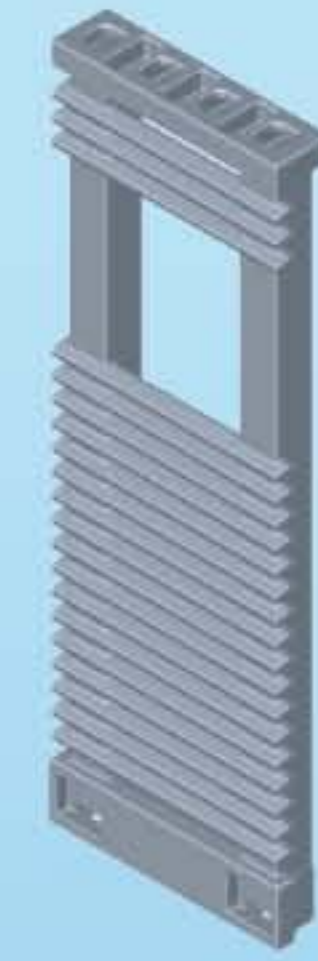

2x 30 22 3563



30 05 4490

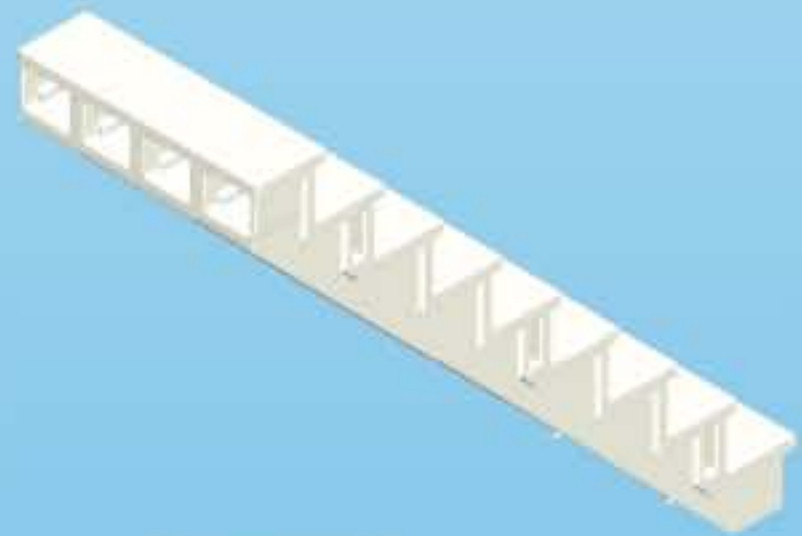

30 22 3843



30 22 3583



30 66 6610



2x 30 66 7770



30 67 3752



30 28 6200

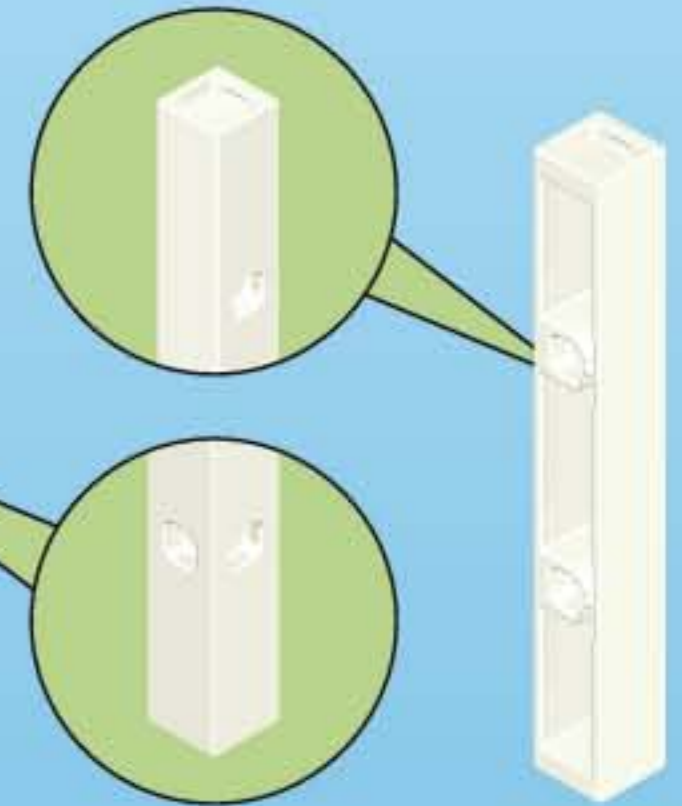

30 06 7620



30 22 3573



30 22 3623



30 28 9530



30 22 3593



30 27 1940



30 22 3703

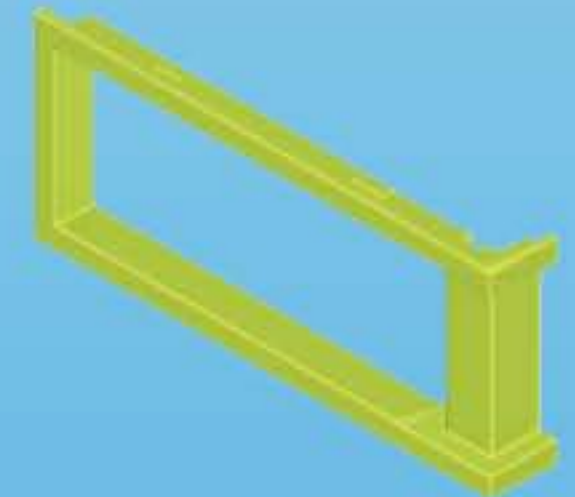

2x 30 22 3663

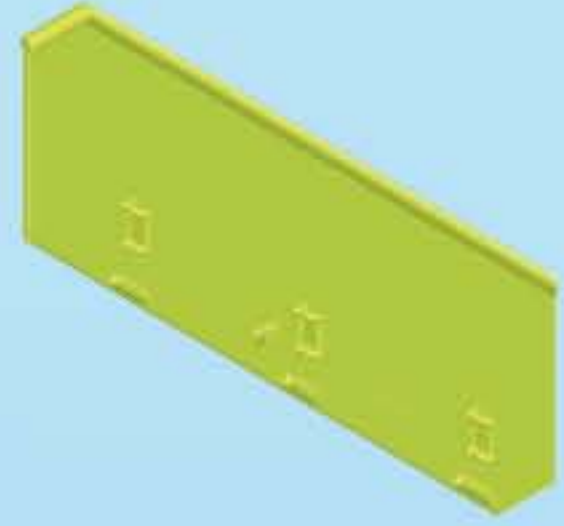

30 22 3833



30 22 3633

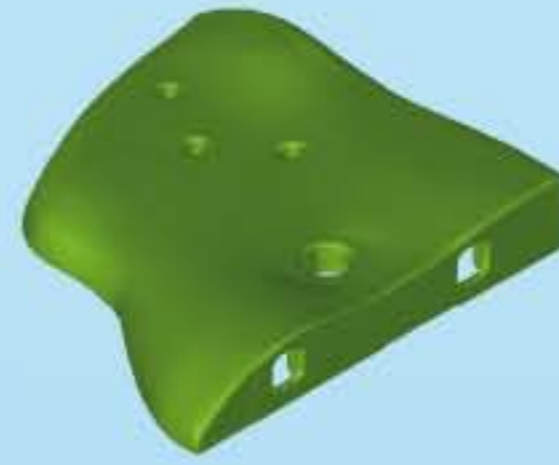

2x 30 22 5860

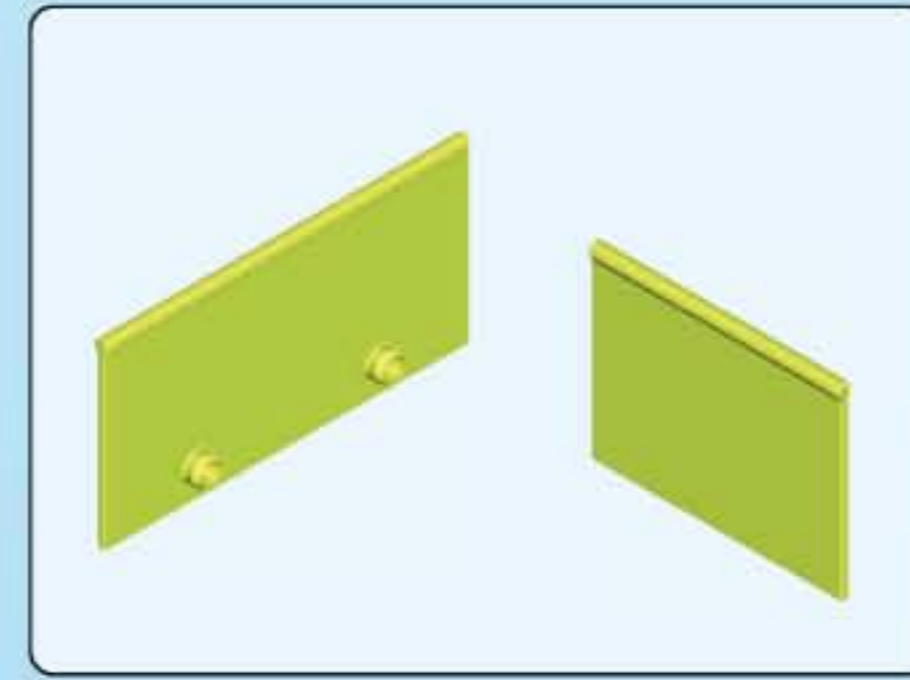

30 60 3702



30 51 8530

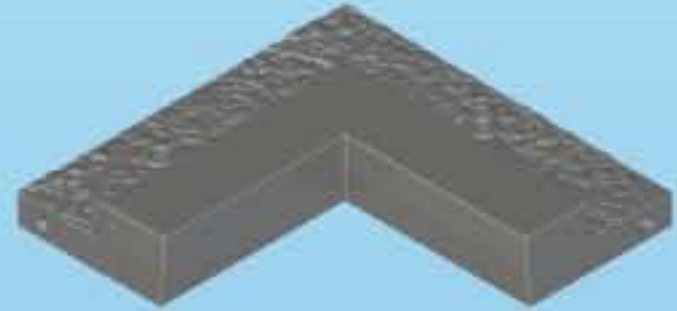

30 22 3553

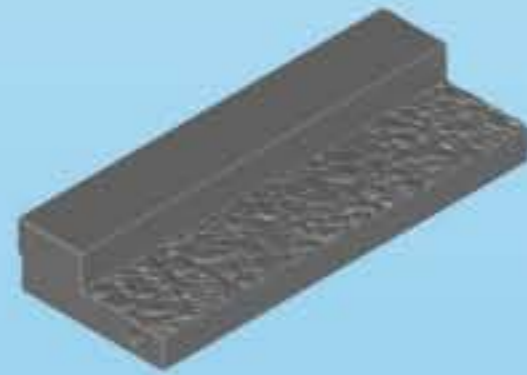

5x 30 22 3533



3x 30 22 3693



30 25 2142



30 25 2132



30 22 3853



30 51 8990

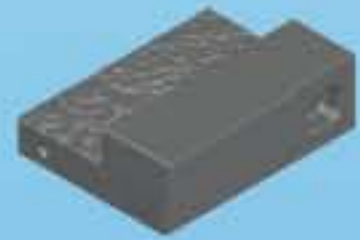

30 22 3513

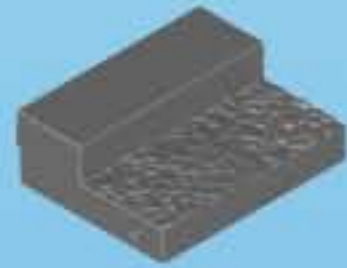

2x 30 22 3523

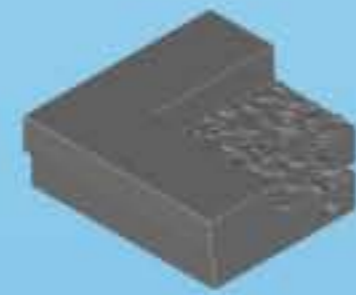

3x 30 22 3543



30 25 9003

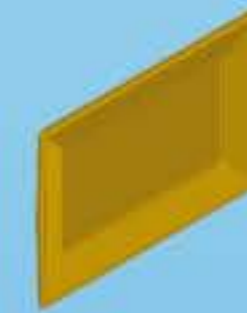

30 22 3503



30 22 3493



30 22 1280



30 21 3093



30 22 3483



30 27 1950



30 22 3733



30 27 0010



2x 30 23 8440



5x 30 23 8430



30 60 6610



2x 30 61 4630



30 03 2890



30 20 7302



30 22 3463



30 22 3643



3x 30 09 2110



2x 30 03 2920



30 26 9070



30 22 0560



30 22 3823



5x 30 24 1862



30 21 0950



2x 30 22 3323



30 02 1220



30 29 7160



12x 30 04 8770



4x 30 09 4659



16x 30 09 2120



4x 30 25 1280



3x 30 22 3443



3x 30 22 3453



142x 30 09 6900



16x 30 03 6600

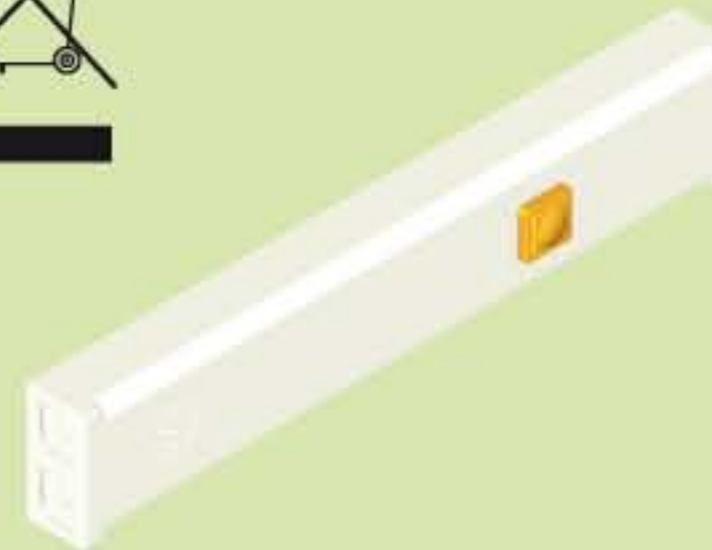
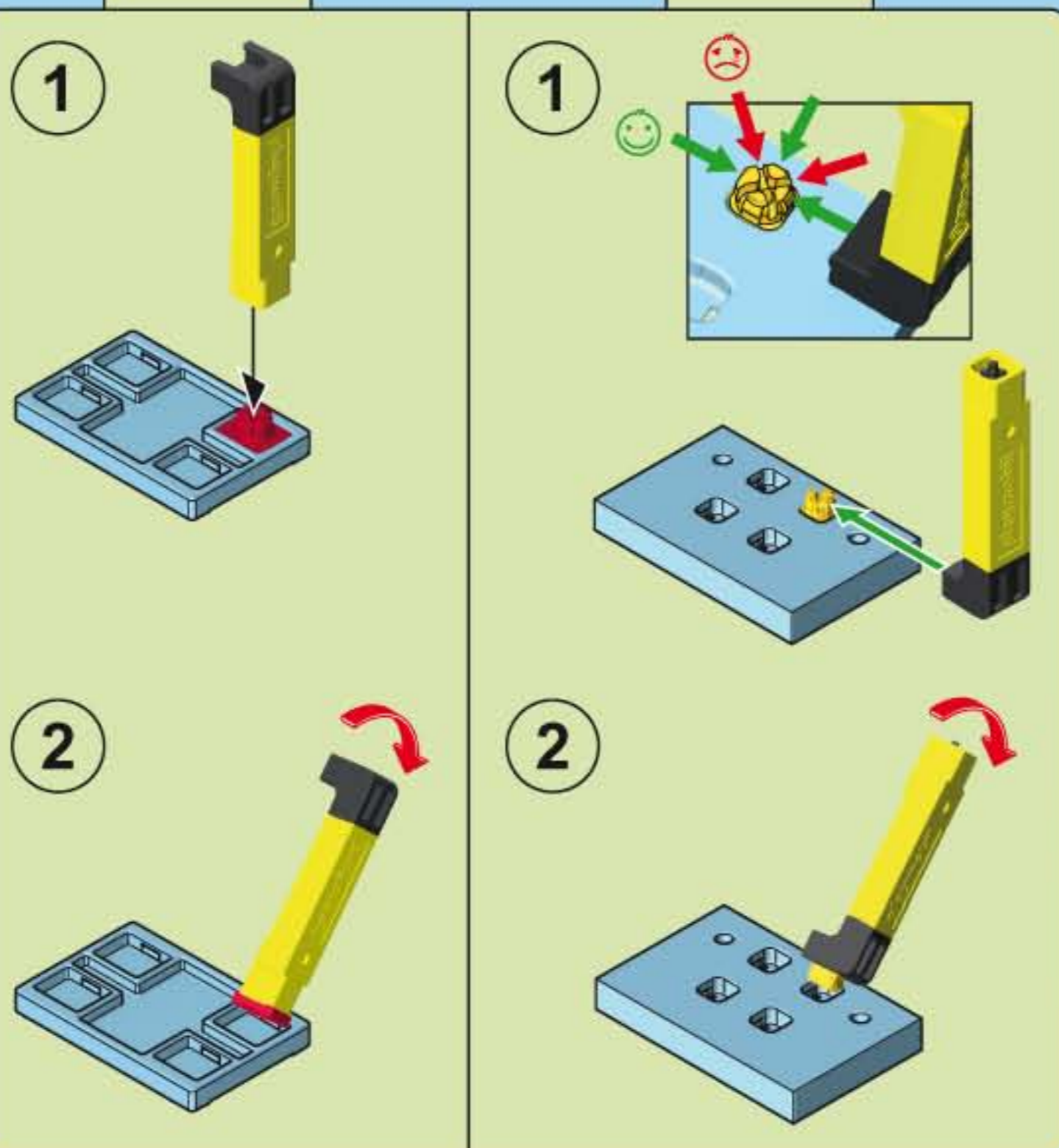

D A CH L B Denken Sie an den Schutz der Umwelt !

- Ihr Gerät enthält wertvolle Rohstoffe, die wieder verwertet werden können.
- Geben Sie Ihr Gerät deshalb bitte bei einer Sammelstelle Ihrer Stadt oder Gemeinde ab.

GB M IRL Environment protection first !

- Your appliance contains valuable materials which can be recovered or recycled.
- Leave it at a local civic waste collection point.

F L CH Participons à la protection de l'environnement !

- Votre appareil contient de nombreux matériaux valorisables ou recyclables.
- Confiez celui-ci dans un point de collecte pour que son traitement soit effectué.

E ¡¡ Participe en la conservación del medio ambiente !!

- Su electrodoméstico contiene materiales recuperables y/o reciclables.
- Entréguelo al final de su vida útil, en un Centro de Recogida Específico o en uno de nuestros Servicios Oficiales Post Venta donde será tratado de forma adecuada.

NL B Samen het milieu beschermen !

- Uw product bevat meerdere recycleerbare materialen
- Breng deze naar een afval-inzamelpunt.

B Participons à la protection de l'environnement !

- Votre appareil contient de nombreux matériaux valorisables ou recyclables.
- Confiez celui-ci dans un point de collecte ou à défaut dans un centre service agréé pour que son traitement soit effectué.

I CH Partecipiamo alla protezione dell'ambiente !

- Il vostro apparecchio è composto da diversi materiali che possono essere riciclati.
- Lasciatelo in un punto di raccolta o presso un Centro Assistenza Autorizzato.

P Protecção do ambiente em primeiro lugar!

- O seu produto contém materiais que podem ser recuperados ou reciclados.
- Entregue-o num ponto de recolha para possibilitar o seu tratamento.

DK Vi skal alle være med til at beskytte miljøet!

- Apparatet indeholder mange materialer, der kan genvindes eller genbruges.
- Bring det til et specialiseret indsamlingssted for genbrug eller et autoriseret serviceværksted, når det ikke skal bruges mere.

S FIN Var rädd om miljön!

- Din apparat innehåller olika material som kan återanvändas eller återvinnas.
- Lämna den på en återvinningsstation eller på en auktoriserad serviceverkstad för omhändertagande och behandling.

FIN Huolehtikaamme ympäristöstä!

- i Laitteesi on varustettu monilla arvokkailla ja kierrätettävillä materiaaleilla.
- Toimita laitteesi keräyspisteeseen tai sellaisen puuttuessa vaikka valtuutettuun huoltokekkukseen, jotta laitteen osat varmasti kierrätetään.

H Első a környezetvédelem!

- Az Ön terméke értékes újrahasznosítható anyagokat tartalmaz.
- Kérjük készülékét ne dobja ki, hanem adja le az erre a célra kijelölt gyűjtőhelyen.

CZ Podílejme se na ochraně životního prostředí!

- Váš přístroj obsahuje četné vhodnotitelné nebo recyklovatelné materiály.
- Světe jej sběrnému místu nebo, neexistuje-li, smluvnímu servisnímu středisku, kde s ním bude naloženo odpovídajícím způsobem.

SLO Sodelujmo pri varovanju okolja!

- Vaš aparat vsebuje številne dele, ki imajo svojo vrednost ali jih je še mogoče uporabiti.
- Oddajte ga na mestu za zbiranje odpadkov ali pa na pooblaščenem servisu, da bo šel v predelavo.

SK Podieľajme sa na ochrane životného prostredia!

- Váš prístroj obsahuje četné vhodnotiteľné alebo recyklovateľné materiály.
- Zverte ho sběrnému miestu alebo, ak neexistuje, zmluvnému servisnému stredisku, kde s ním bude naložené zodpovedajúcim spôsobom.

PL Bierzmy czynny udział w ochronie środowiska!

- Twoje urządzenie jest zbudowane z materiałów, które mogą być poddane ponownemu przetworzeniu lub recyklingowi.
- W tym celu należy je dostarczyć do wyznaczonego punktu zbiórki.

GR CY Ας συμβάλλουμε κι εμείς στην προστασία του περιβάλλοντος!

- Η συσκευή σας περιέχει πολλά αξιοποιήσιμα ή ανακυκλώσιμα υλικά.
- Παραδώστε την παλιά συσκευή σας σε κέντρο διαλογής ή σε ένα εξουσιοδοτημένο κατάστημα σέρβις.

RO Țineți cont de protecția mediului !

- Aparatul dvs. conține materii prime valoroase care pot fi revalorificate.
- Din acest motiv vă rugăm să predați aparatul dvs. la un centru de colectare din orașul sau comuna dvs.

BG Мислете за околната среда !

- Вашият уред съдържа ценни суровини, които могат да бъдат рециклирани.
- Затова върнете своя електроуред на специално място за събиране на такива отпадъци във Вашия град или община.

5574 + 5586



1

5574

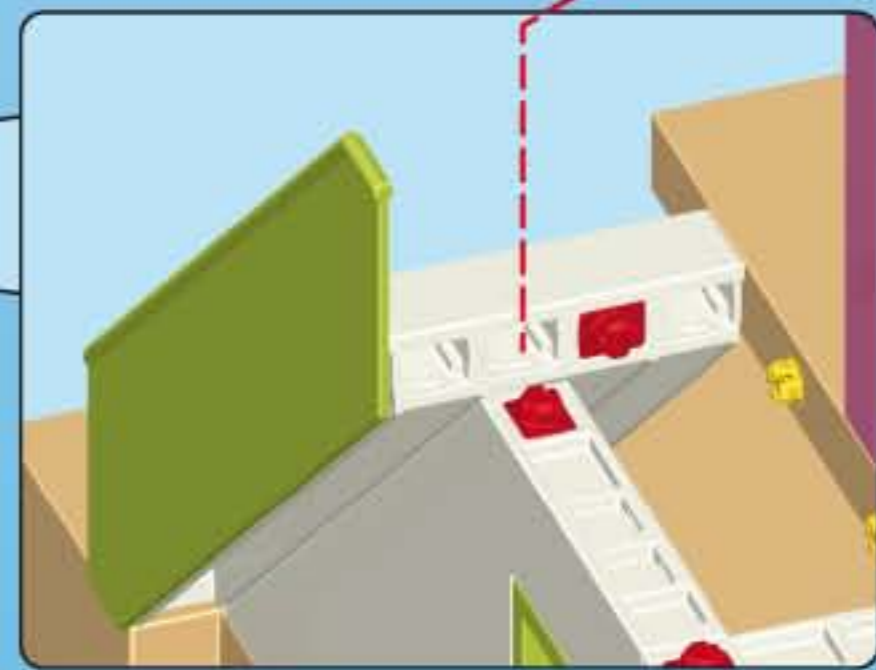
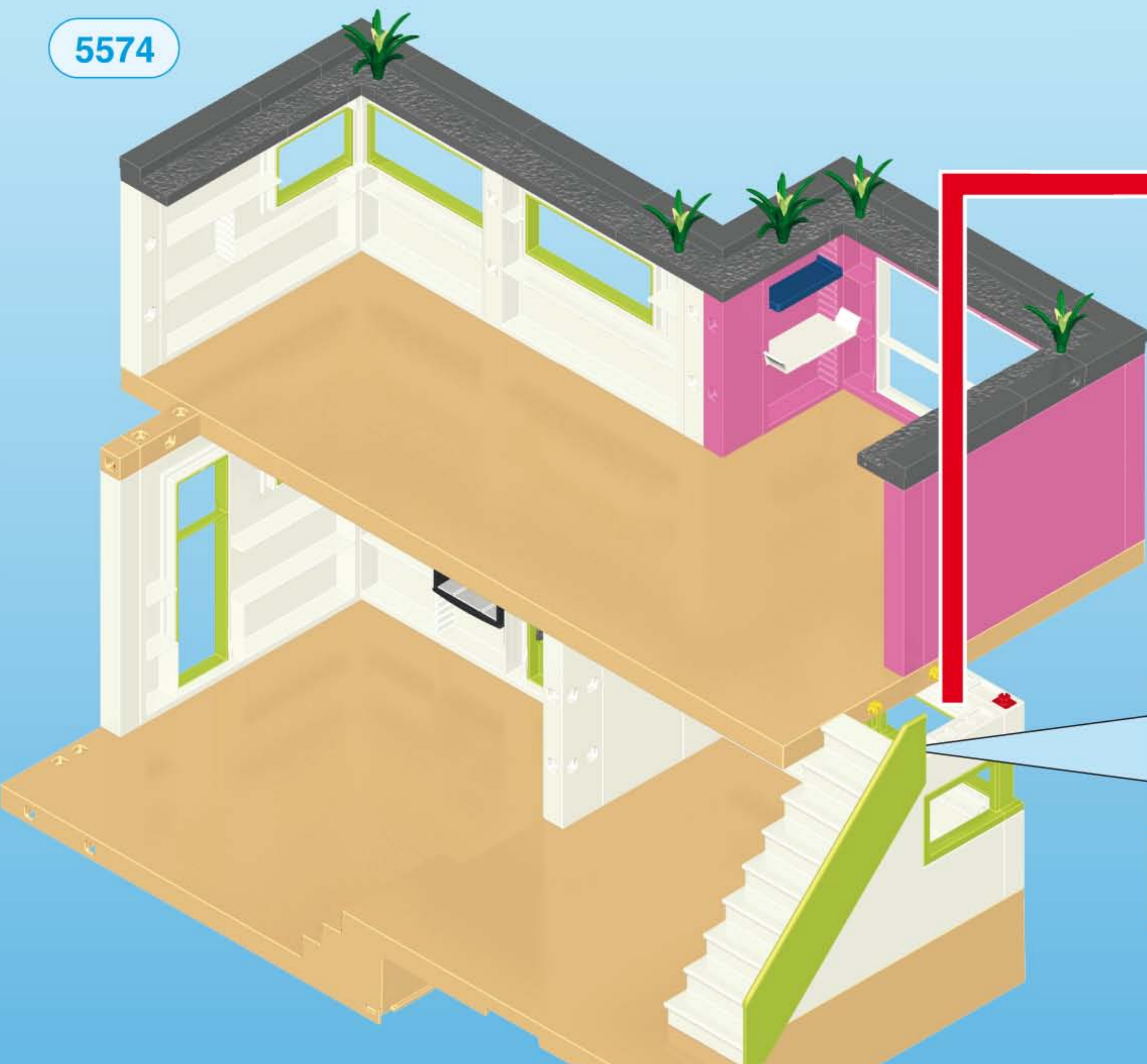

2

5586

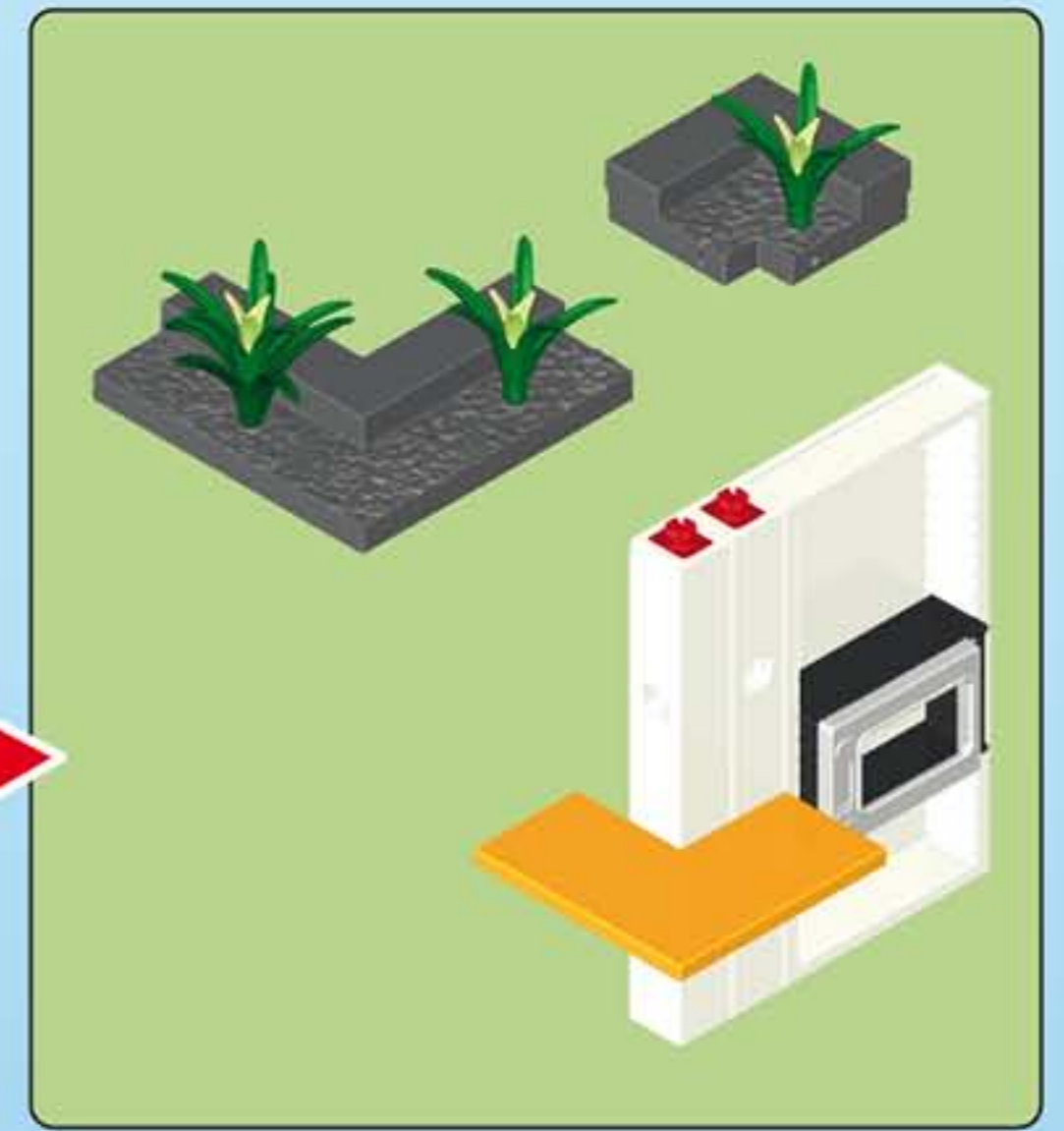
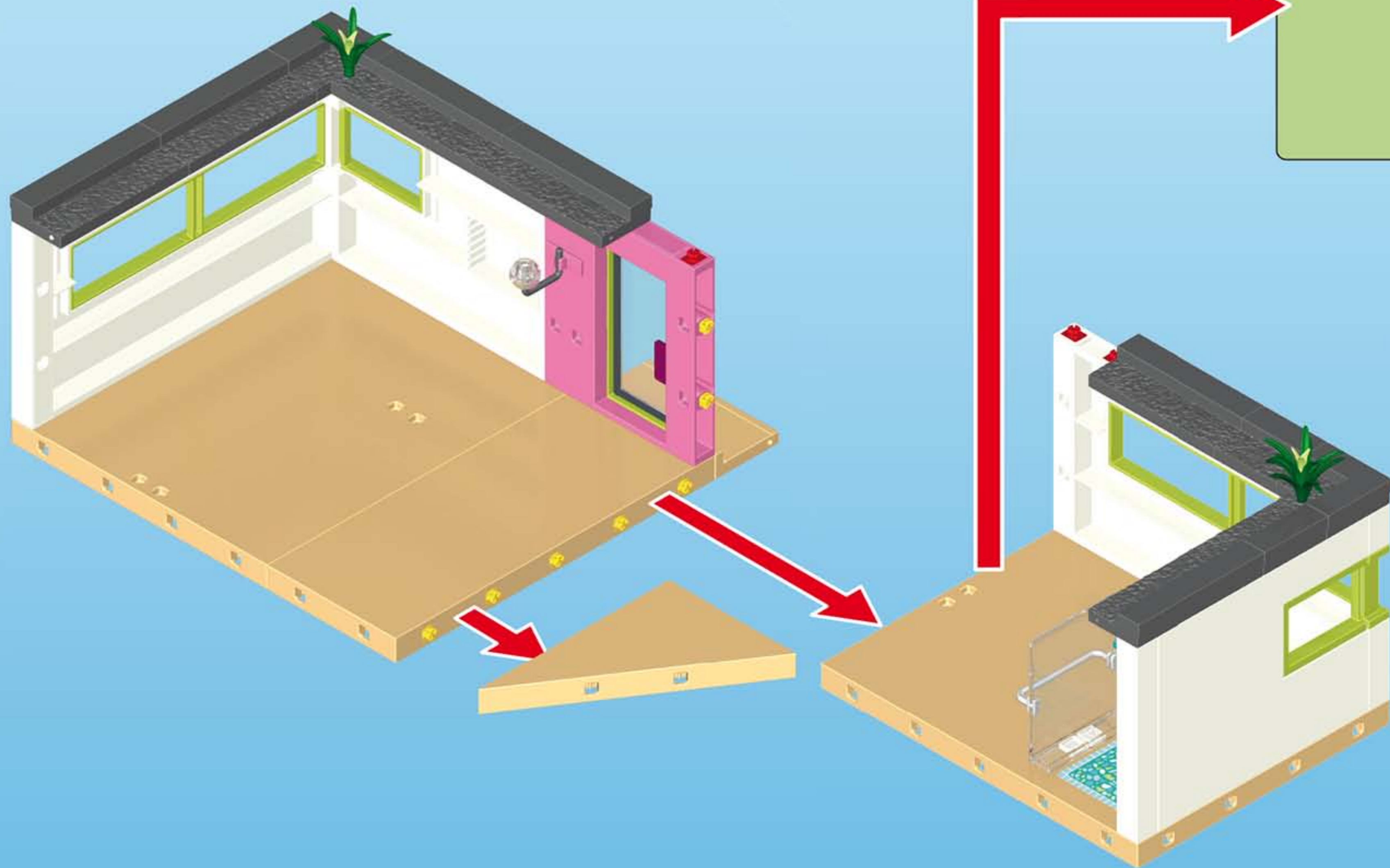

3

5586

5586

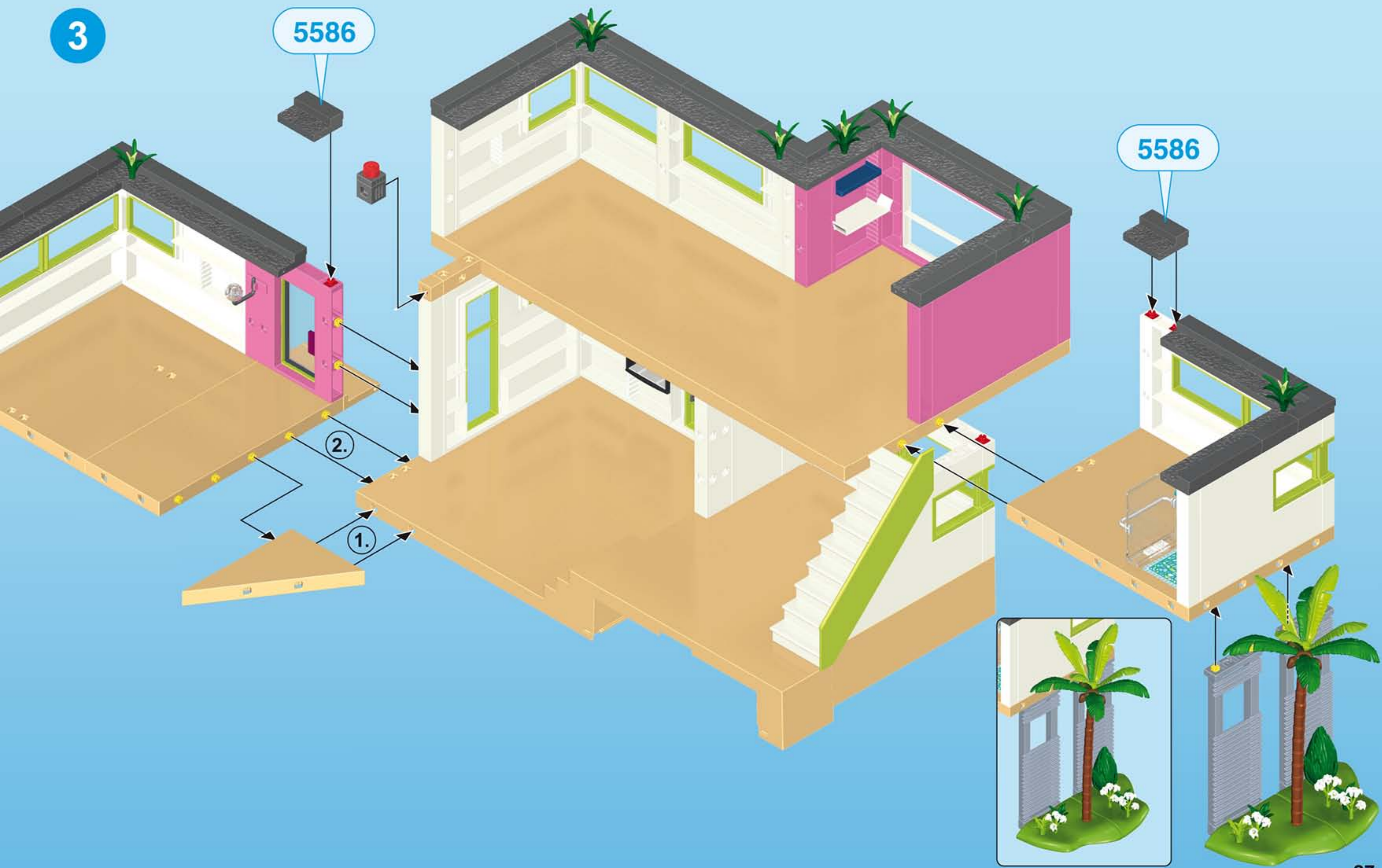

5574 + 6389



Serviceadressen finden Sie in allen Playmobil-Prospekten

Addresses of Customer Service Departments are shown in all Playmobil catalogues

L'adresse du service consommateurs est indiquée dans tous les catalogues Playmobil

Troverete gli indirizzi dei centri di assistenza in tutti i cataloghi Playmobil

In alle PLAYMOBIL catalogi vindt u het adres van onze klantendienst.

Las Direcciones de los Departamentos de Servicio al Consumidor se encuentran en todos los catálogos Playmobil

Η διεύθυνση του Γραφείου Εξυπηρέτησης Καταναλωτών PLAYMOBIL βρίσκεται σε όλους τους καταλόγους PLAYMOBIL.

pronounce: plāy-mō-bēēl

USA

This device complies with Part 15 of the FCC Rules. Operation is subject to the following two conditions:

- (1) This device may not cause harmful interference, and
- (2) this device must accept any interference received, including interference that may cause undesired operation.

CDN

CAN ICES-3 (B)/NMB-3(B)

Cet équipement est conforme à la Section 15 des règlements de la FCC. Son fonctionnement est soumis aux deux conditions suivantes:

- (1) Cet équipement ne peut causer d'interférence nuisible, et
- (2) cet équipement doit pouvoir fonctionner même s'il capte de l'interférence, incluant celle pouvant provoquer un fonctionnement indésirable.

