

playmobil®
5289

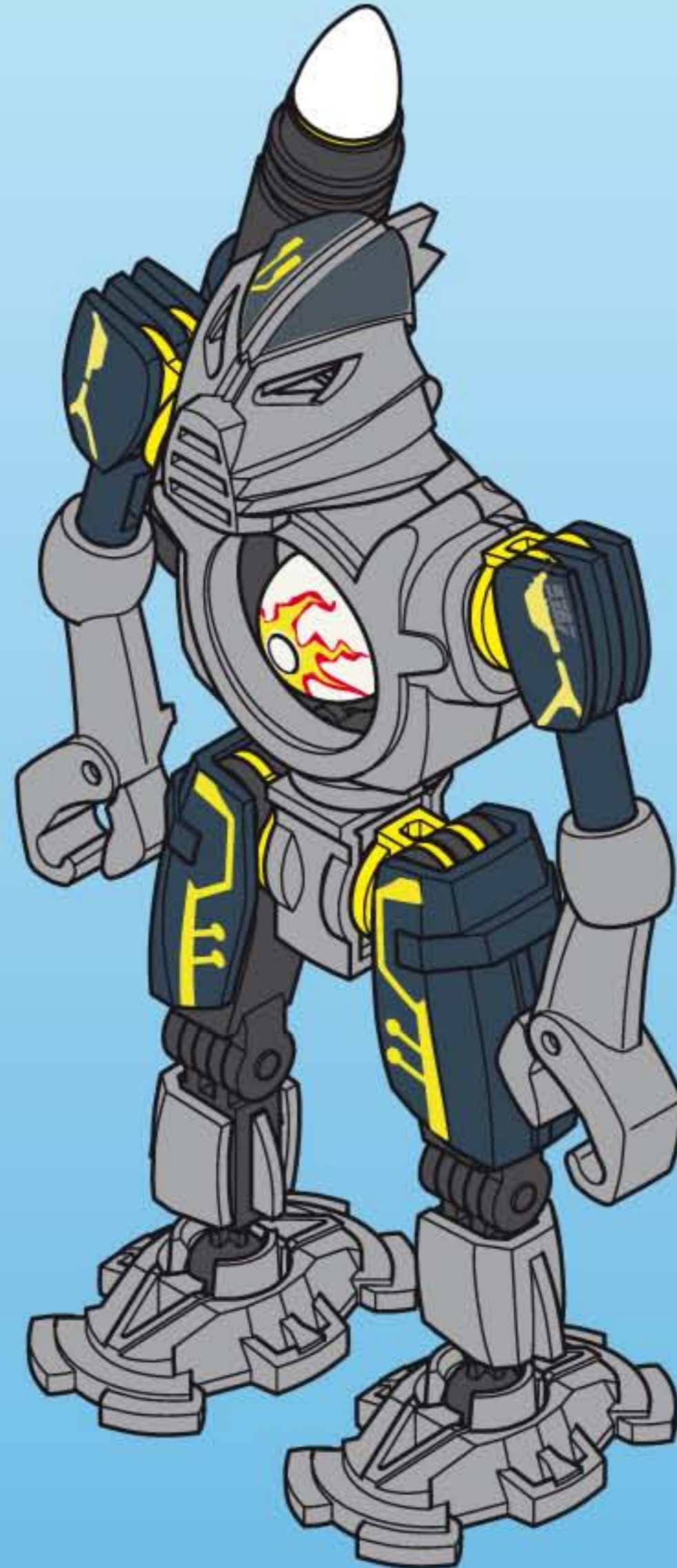

Wichtige Unterlagen, bitte sorgfältig aufbewahren !
Important: Please keep these instructions for future reference !
Documents importants, à conserver soigneusement !
Belangrijke documenten, bewaar deze zorgvuldig !



WARNING:
CHOKING HAZARD

Contains a small ball and small parts.
Not for children under 3 years.

”Ne concerne que les USA“

1

30 80 5133

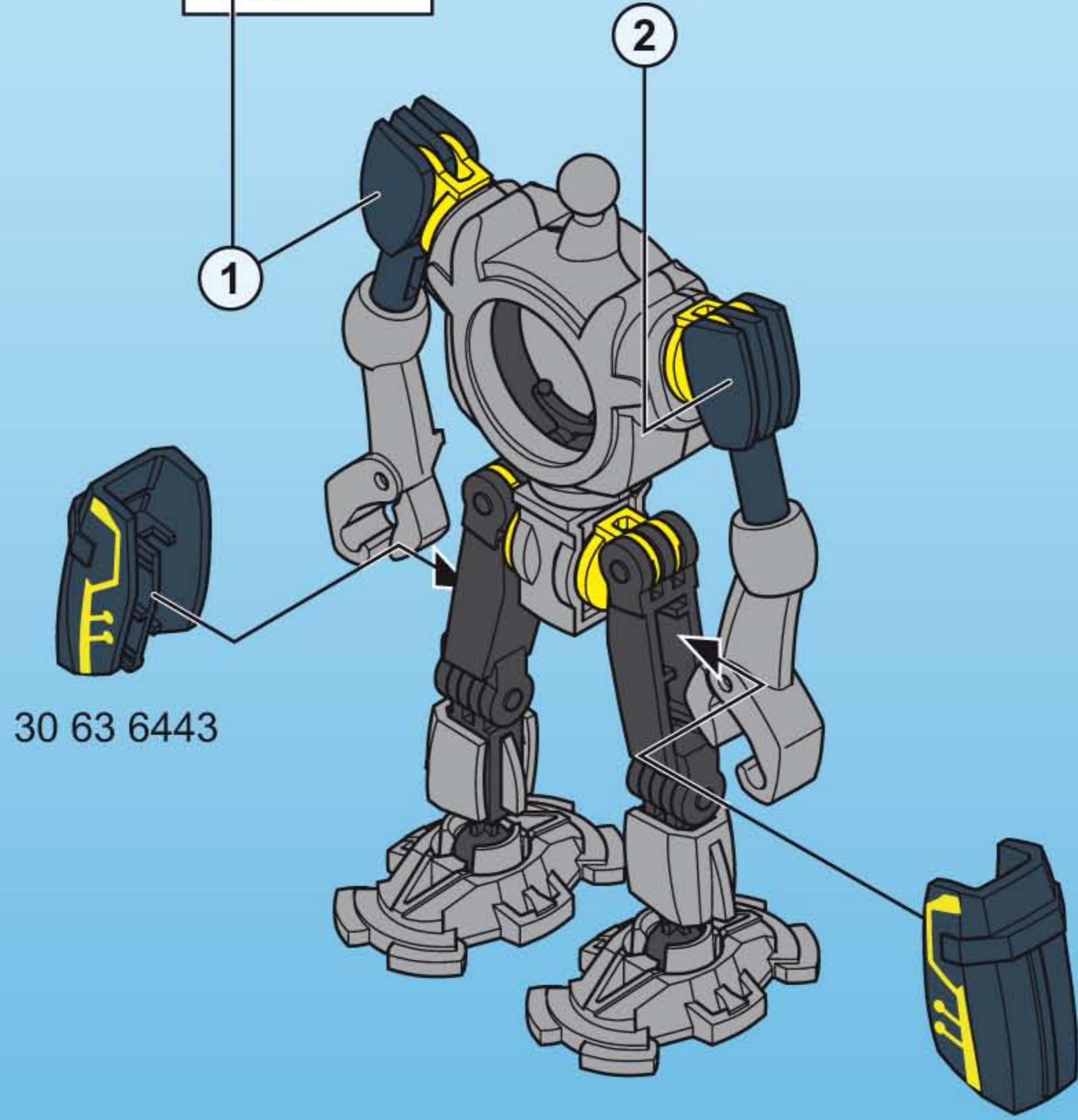

2

2

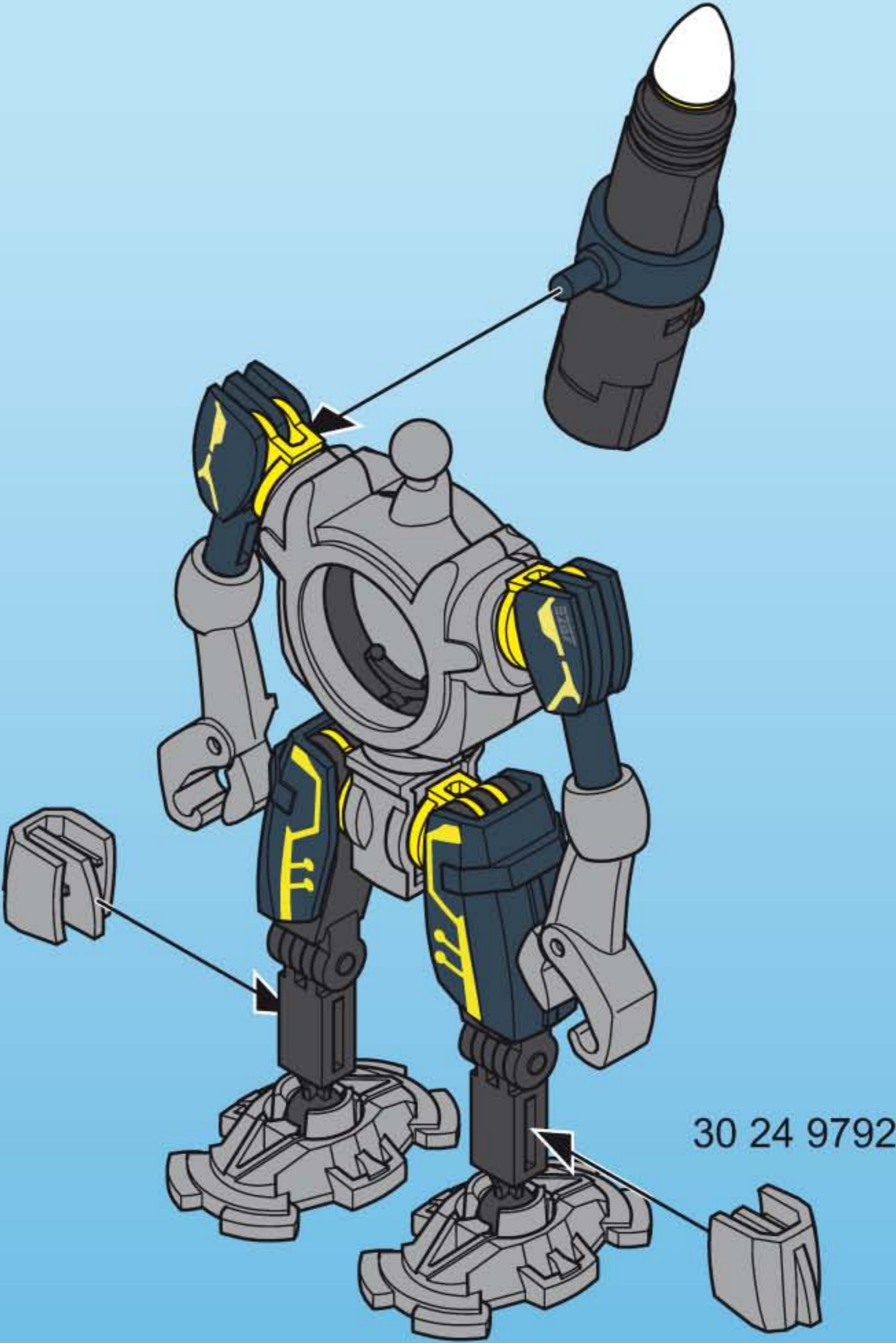
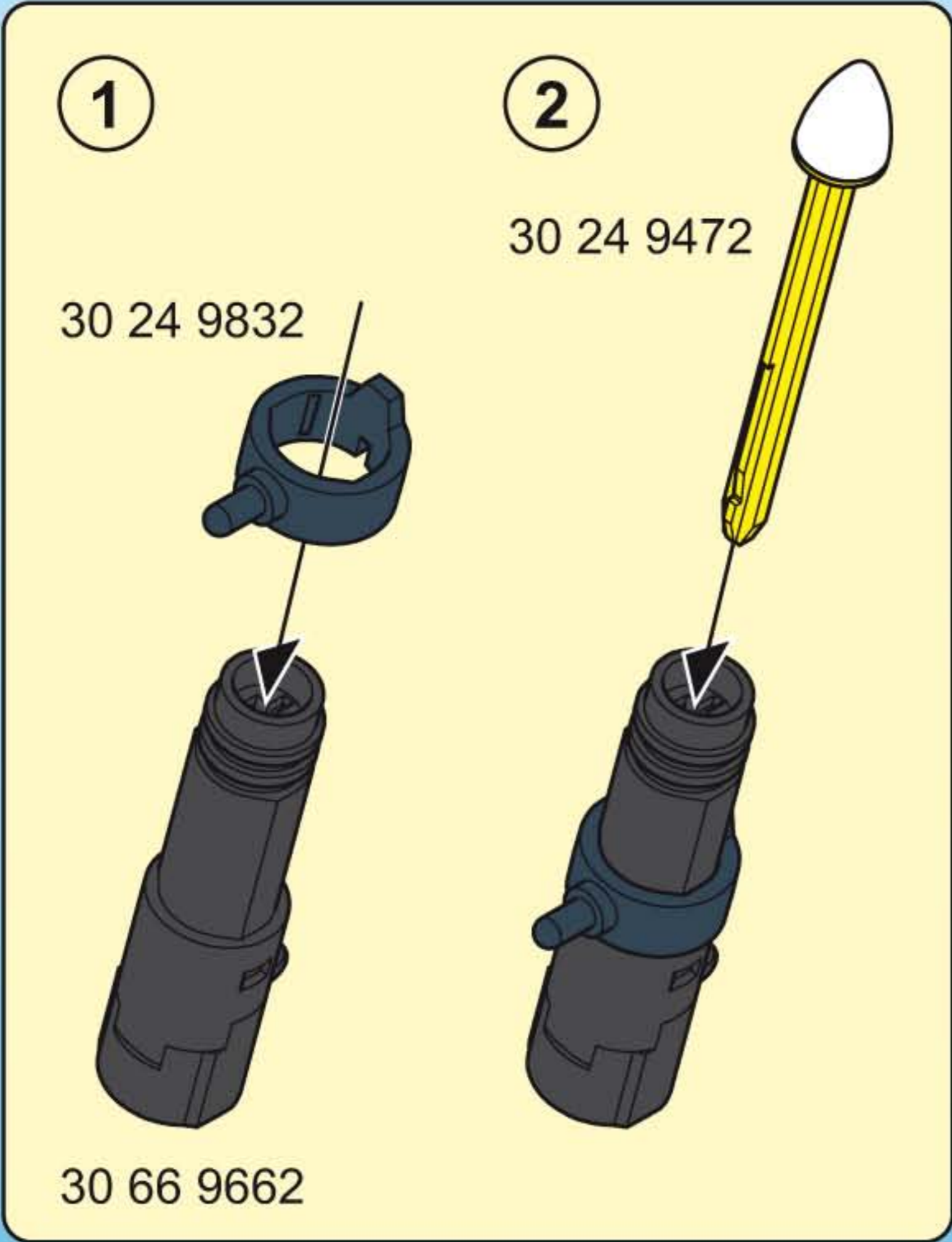

3

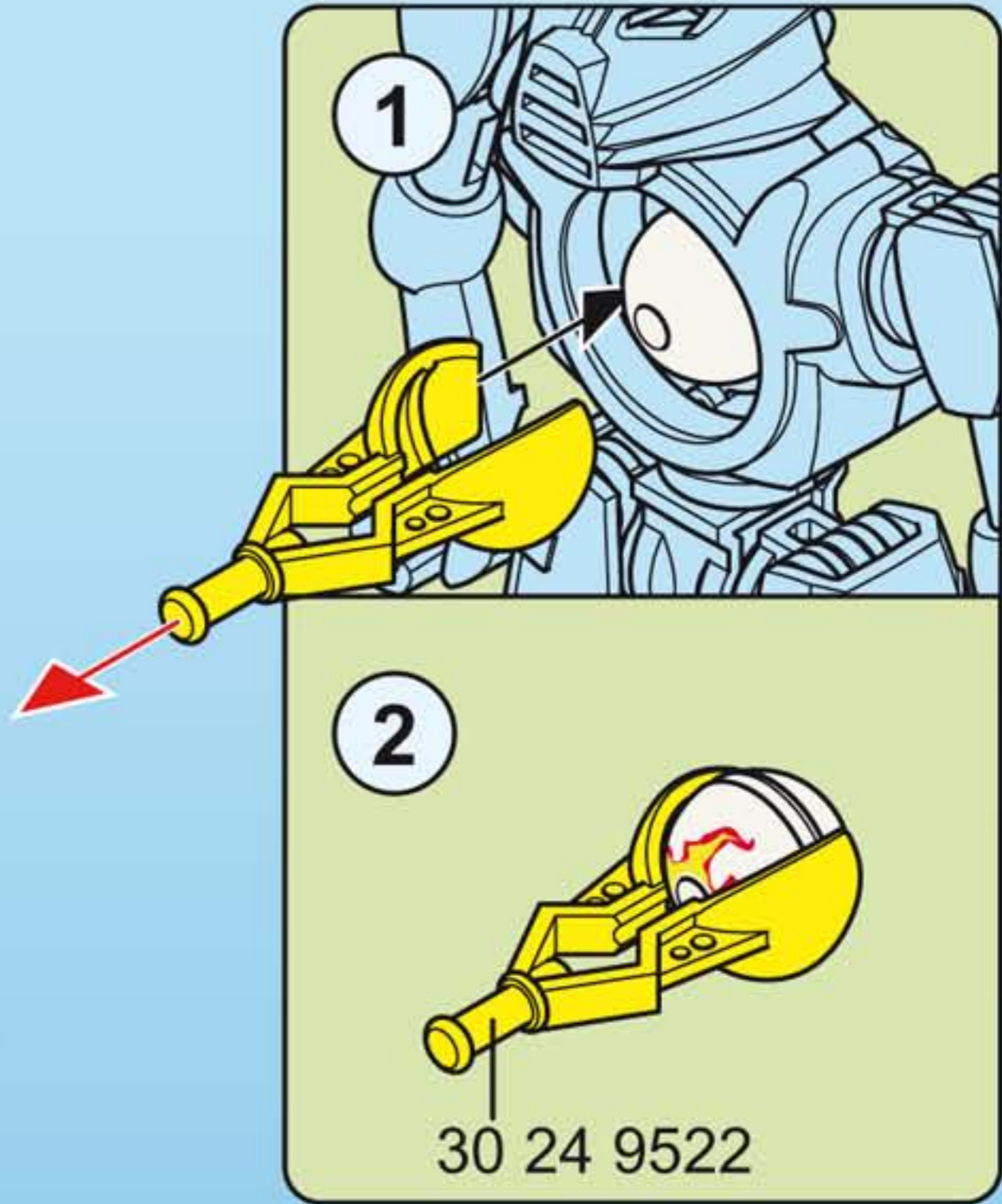
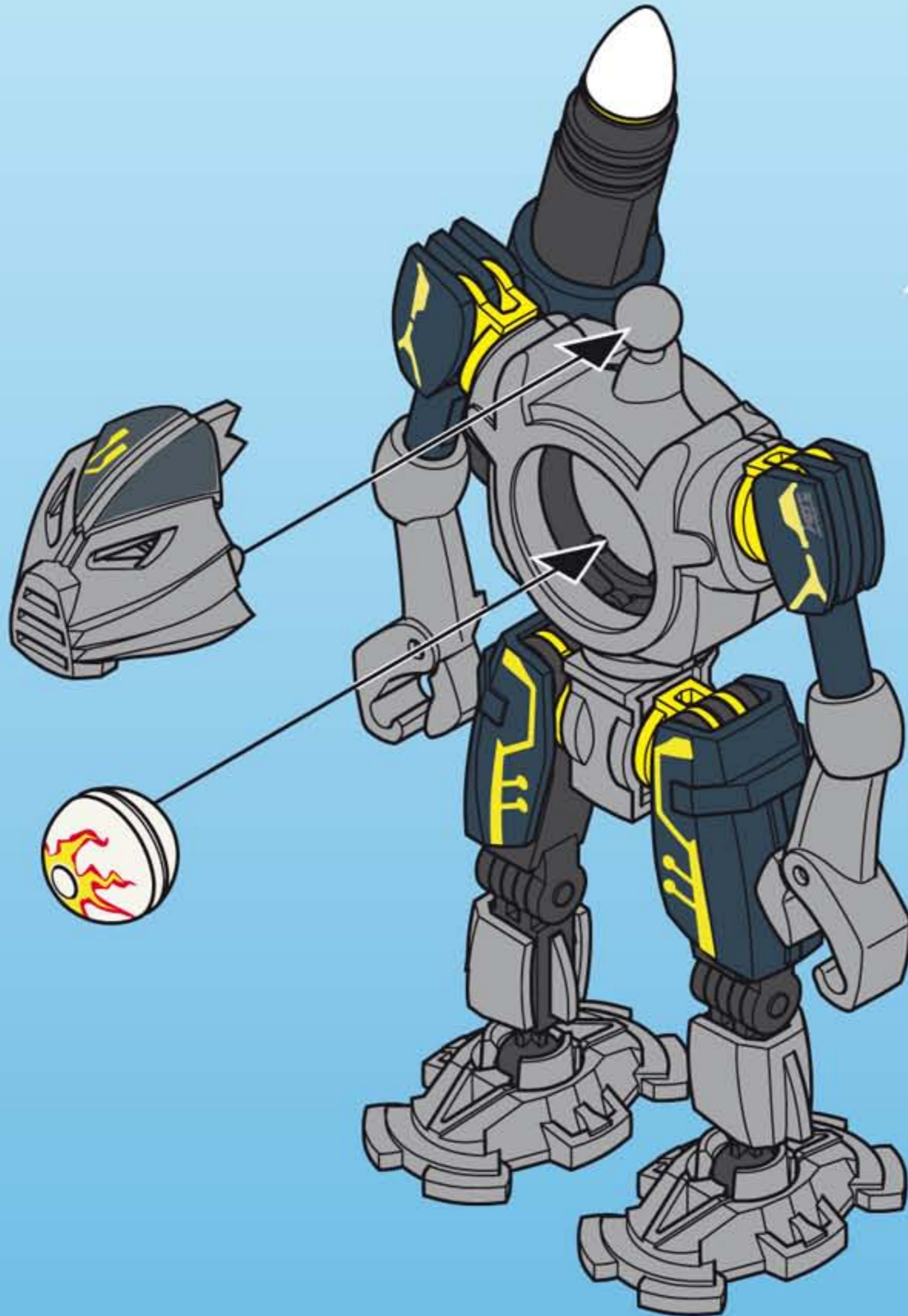
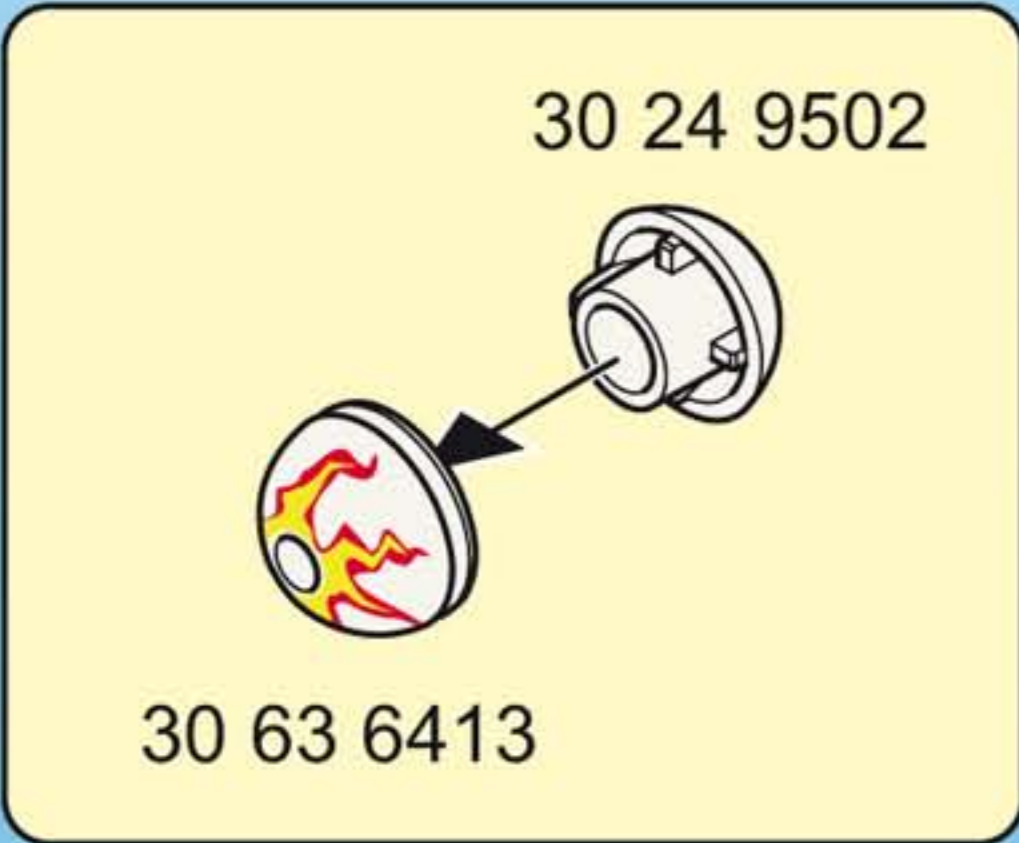
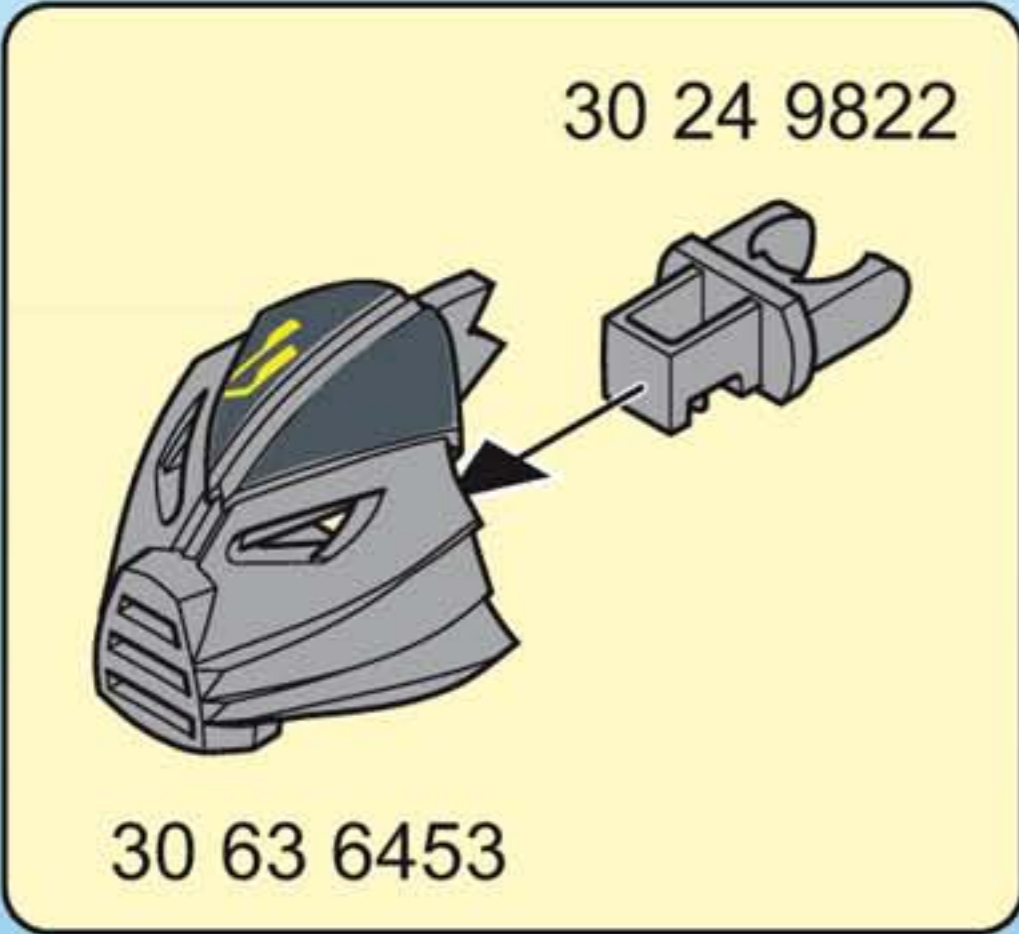

- D A CH L B ACHTUNG!** Nur mitgelieferte PLAYMOBIL Geschosse verwenden. Nicht auf Augen oder Gesicht zielen.
- USA GB CDN M IRL WARNING!** Only use the PLAYMOBIL projectiles supplied. Do not aim at eyes or face.
- F CDN B L CH ATTENTION!** Seulement utiliser les projectiles PLAYMOBIL fournis. Ne pas viser les yeux ou le visage
- E MEX ; ADVERTENCIA!** Utiliza únicamente los proyectiles PLAYMOBIL suministrados. No se ha de apuntar a los ojos ni a la cara.
- NL B WAARSCHUWING!** Uitsluitend meegeleverde PLAYMOBIL delen gebruiken. Niet op ogen of gezicht richten.
- I CH ATTENZIONE!** Usare soltanto i proiettili PLAYMOBIL in dotazione. Non mirare agli occhi o al viso.
- P AVISO!** Usar apenas os projécteis PLAYMOBIL juntamente fornecidos. Não apontar para os olhos ou face.
- DK ADVARSEL!** Anvend kun de medfølgende PLAYMOBIL projektiler. Sigt ikke mod øjne eller ansigt.
- N ADVARSEL!** Benytt kun PLAYMOBIL prosjektil som leveres med. Sikt ikke på ansikt eller øyne.
- S FIN VARNING!** Använd endast medlevererade PLAYMOBIL-skott. Sikta ej mot ögonen eller ansiktet.
- FIN VAROITUS!** Käytä vain mukana toimitettuja PLAYMOBIL-ammuksia. Älä tähtää päin silmiä tai kasvoja.
- H FIGYELEM!** Csak a csomagban található PLAYMOBIL lövedékeket szabad használni. Óvd a szemeidet és az arcod!
- CZ VAROVÁNÍ!** Používejte pouze střely PLAYMOBIL, které jsou součástí dodávky. Nemiřte na oči nebo na obličej!
- EST HOIATUS!** Kasutage ainult kaasaantud PLAYMOBIL'i laskemoona. Ära sihi silmadesse ega näkku.
- LV BRĪDINĀJUMS!** Izmantot tikai PLAYMOBIL piegādes komplektā iekļautos šāviņus. Nevērst pret acīm vai seju.
- LT DĖMESIO!** Naudokite tik pridedamus PLAYMOBIL šaudmenis. Netaikyti į akis arba veidą.
- SLO OPOZORILO!** Uporabljajte le priložene PLAYMOBIL-ove kroglice. Ne merite v oči ali obraz.
- SK UPOZORNENIE!** Používajte len náboje dodávané spolu so sadou PLAYMOBIL. Nemieriť do očí alebo do tváre.
- PL UWAGA!** Stosować tylko załączone PLAYMOBIL - kule / pociski. Nie celować w oczy i twarz.

TR **CY** **UYARI!** Sadece birlikte verilen PLAYMOBIL mermileri kullanınız. Göze veya yüze doğru tutmayınız.

GR **CY** **ΠΡΟΣΟΧΗ!** Να χρησιμοποιούνται αποκλειστικά τα βλήματα της PLAYMOBIL που περιέχονται στη συσκευασία.
Μη σκοπεύετε τα μάτια ή το πρόσωπο.

RO **AVERTIZARE!** Se folosesc doar proiectilele incluse PLAYMOBIL. Nu se țintește în ochi sau în față.

BG **ΠΡΕΔΥΠΡΕЖДЕНИЕ!** Използвайте само приложени PLAYMOBIL снаряди. Не насочвайте към очите и лицето.

CN **警告!** 仅能用PLAYMOBIL的炮弹. 禁止瞄准眼睛或脸. 请勿瞄准眼睛或脸.

30 24 9842



30 24 9722

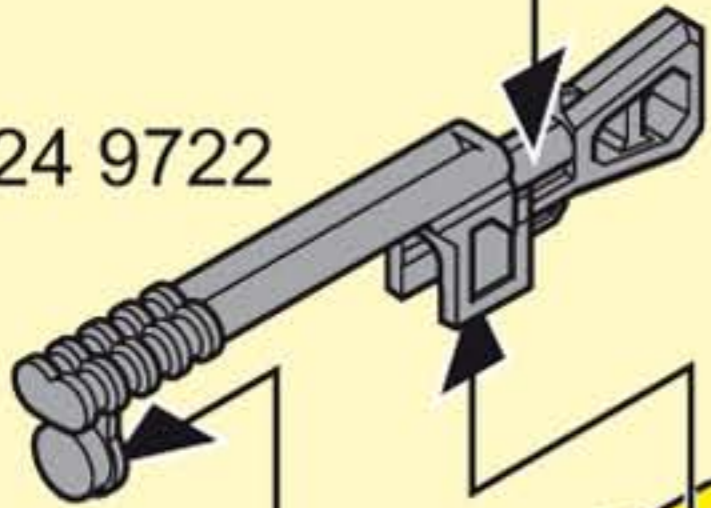

30 24 9712



30 23 7350

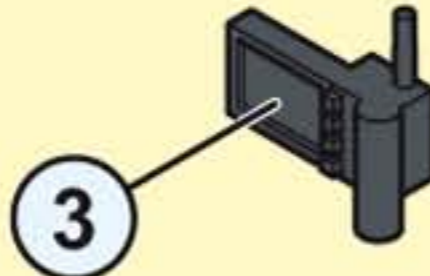



2x 30 07 8330



30 63 6463

30 00 1673



30 24 1010

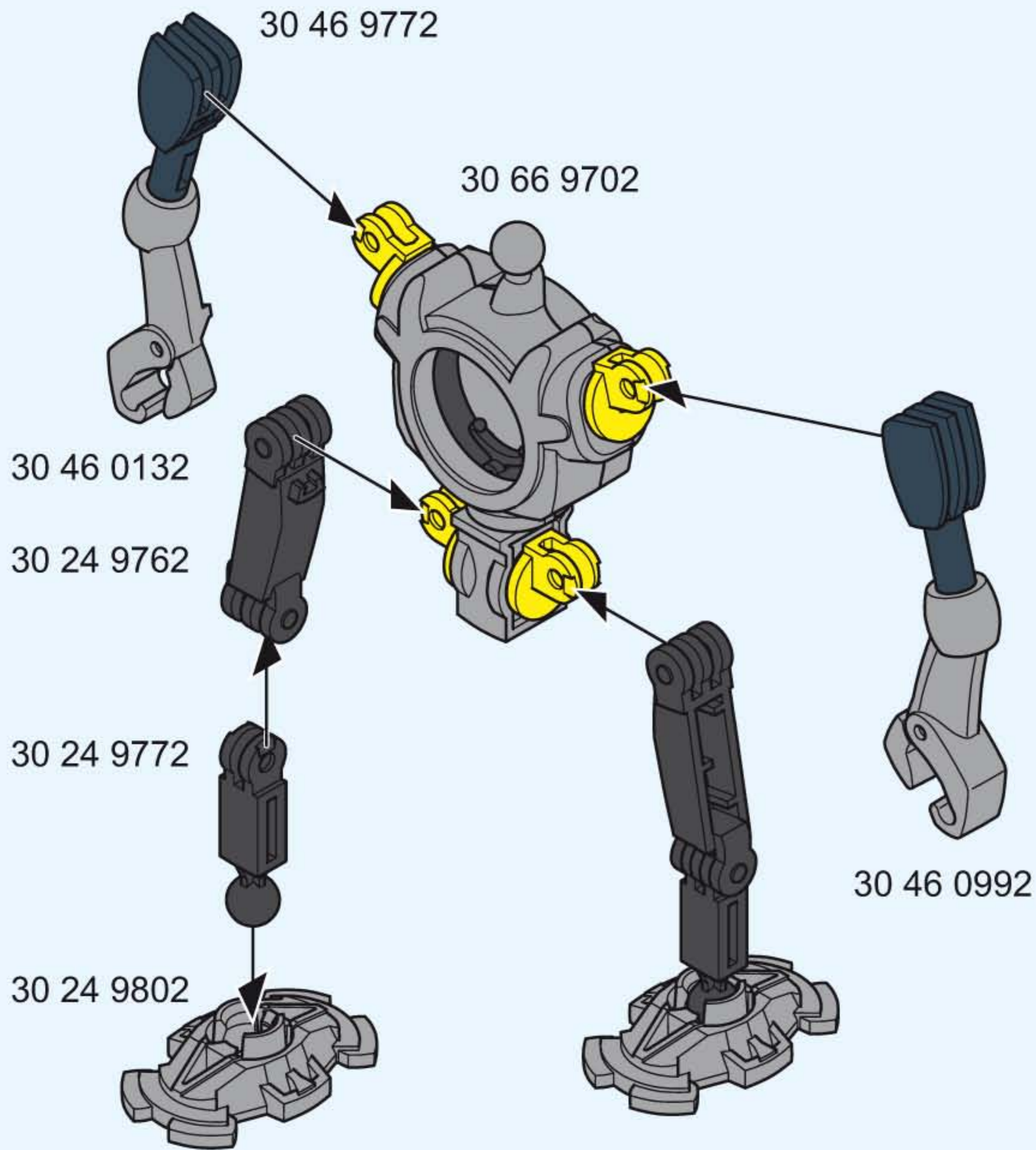

Serviceadressen finden Sie in allen Playmobil-Prospekten

Addresses of Customer Service Departments are shown in all Playmobil catalogues

L'adresse du service consommateurs est indiquée dans tous les catalogues Playmobil

Troverete gli indirizzi dei centri di assistenza in tutti i cataloghi Playmobil

In alle PLAYMOBIL catalogi vindt u het adres van onze klantendienst.

Las Direcciones de los Departamentos de Servicio al Consumidor se encuentran en todos los catálogos Playmobil

Η διεύθυνση του Γραφείου Εξυπηρέτησεως Πελατών είναι καταχωρημένη σε όλους τους καταλόγους Playmobil

pronounce: plāy-mō-bēēl

© 2012 geobra Brandstätter GmbH & Co.KG,
 POSTBOX 1260, 90511 Zirndorf, Germany.
 No. 30 80 5183 12.12