

playmobil®

5276



WARNING: CHOKING HAZARD

Small parts. Not for children under 3 years.

"Ne concerne que les USA"

Wichtige Unterlagen, bitte sorgfältig aufbewahren!
Important: Please keep these instructions for future reference!
Documents importants, à conserver soigneusement!
Belangrijke documenten, bewaar deze zorgvuldig!

5159
7350

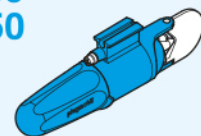

- Nachrüstbar mit Unterwassermotor
- Compatible with the underwater motor (sold separately)
- Monteur submersible, vendu séparément, s'adapte sur ce bateau

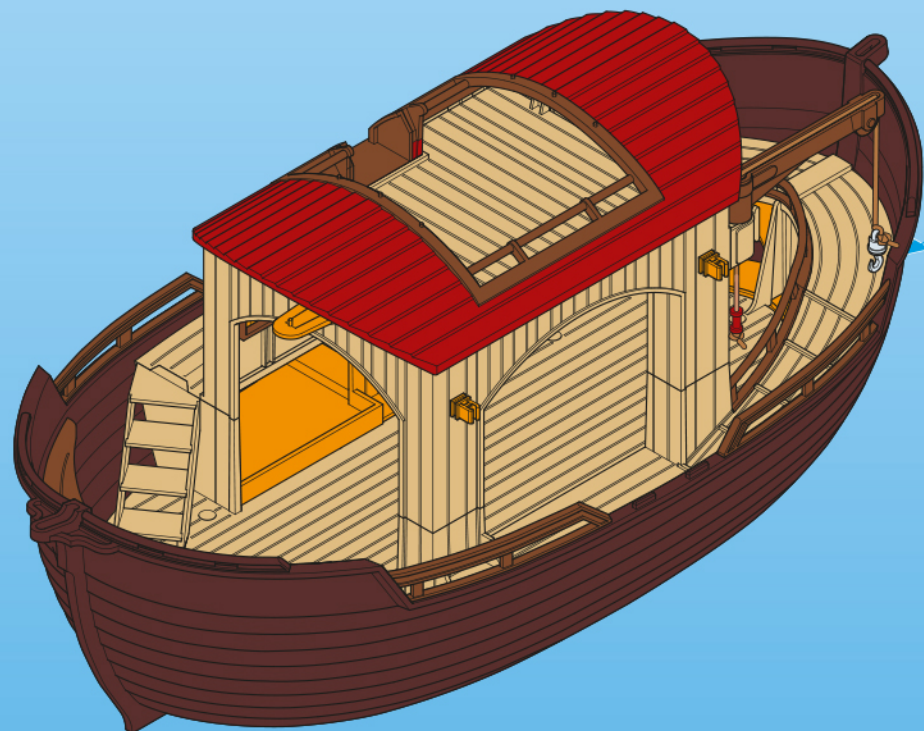

- (D) (A) (CH) (L) (B) **ACHTUNG!** Nur im flachen Wasser unter Aufsicht von Erwachsenen verwenden.
- (USA) (GB) (CDN) (M) (IRL) **WARNING!** Only to be used in water in which the child is within its depth and under adult supervision.
- (F) (CDN) (B) (L) (CH) **ATTENTION!** À n'utiliser qu'en eau où l'enfant a pied et sous la surveillance d'un adulte.
- (E) (MEX) **ADVERTENCIA!** Utilizar sólo en agua donde el niño pueda permanecer de pie y bajo vigilancia de un adulto.
- (NL) (B) **WAARSCHUWING!** Gebruiken in water waar kinderen kunnen staan en onder toezicht van volwassenen.
- (I) (CH) **ATTENZIONE!** Da utilizzare unicamente in acqua dove il bambino tocca il fondo con i piedi e sotto la sorveglianza di un adulto.
- (P) **AVISO!** Só utilizar em água onde a criança tenha pé e sob vigilância de adultos.
- (DK) **ADVARSEL!** Må kun anvendes under opsyn af en voksen og på vanddybder, hvor barnet kan bunde.
- (N) **ADVARSEL!** Skal kun brukes i vann som ikke er for dypt for barnet, og der barnet er under tilsyn.
- (S) (FIN) **WARNING!** Får endast användas i vatten där barnet bottnar och under tilsyn av en vuxen.
- (FIN) **VAROITUS!** Lelua saa käyttää vain aikuisen valvonnassa vedessä, jossa lapsi ylettyy pohjaan.
- (H) **FIGYELMEZTETÉS!** Csak a gyermek magasságához képest biztonságos sekély vízben és felnőtt felügyelete mellett szabad használni!
- (CZ) **VAROVÁNÍ!** Používat pouze ve vodě takové hloubky, kde dítě stačí, a pouze pod dohledem dospělé osoby.
- (EST) **HOIATUS!** Kasutada ainult täiskasvanu järelevalve all vees, kus laps ulatub jalgadega põhja.
- (LV) **BRIDINĀJUMS!** Lietot tikai seklā ūdenī un pieaugušo uzraudzībā.
- (LT) **DĖMESIO!** Naudoti tik vaikai tinkamame gylyje ir prižiūrint suaugusiųsiems.
- (SLO) **OPOZORILO!** Uporabljajte samo v vodi, primerno plitvi za otroka in pod nadzorom odrasle osebe.
- (SK) **UPOZORNENIE!** Používať len vo vode, v ktorej dieťa dočiahne na dno, a pod dohľadom dospelšej osoby.
- (PL) **UWAGA!** Do używania jedynie w wodzie na głębokości, na której dziecko wyczuwa dno pod nogami oraz pod nadzorem osoby dorosłej.
- (TR) (CY) **ΔΙΚΚΑΤ!** Sadece denetim altında ve sadece alçak sularda kullanın.
- (GR) (CY) **ΠΡΟΣΟΧΗ!** Να χρησιμοποιείται μόνο σε νερά όπου πατώνει το παιδί και υπό την επίβλεψη ενηλίκου.
- (RO) **AVERTIZARE!** A se utiliza numai acolo unde copilul poate sta în picioare în apă și este sub supraveghere.
- (BG) **ПРЕДУПРЕЖДЕНИЕ!** Да се използва само във вода, която е дълбока до нормалния ръст на детето, и под надзора на възрастен.
- (HR) **PAŽNJA!** Koristiti samo u plitkoj vodi pod nadzorom odraslih.
- (CN) **警告!** 可供孩子在水中使用，但必须在有人监护的情况下。

1

2x

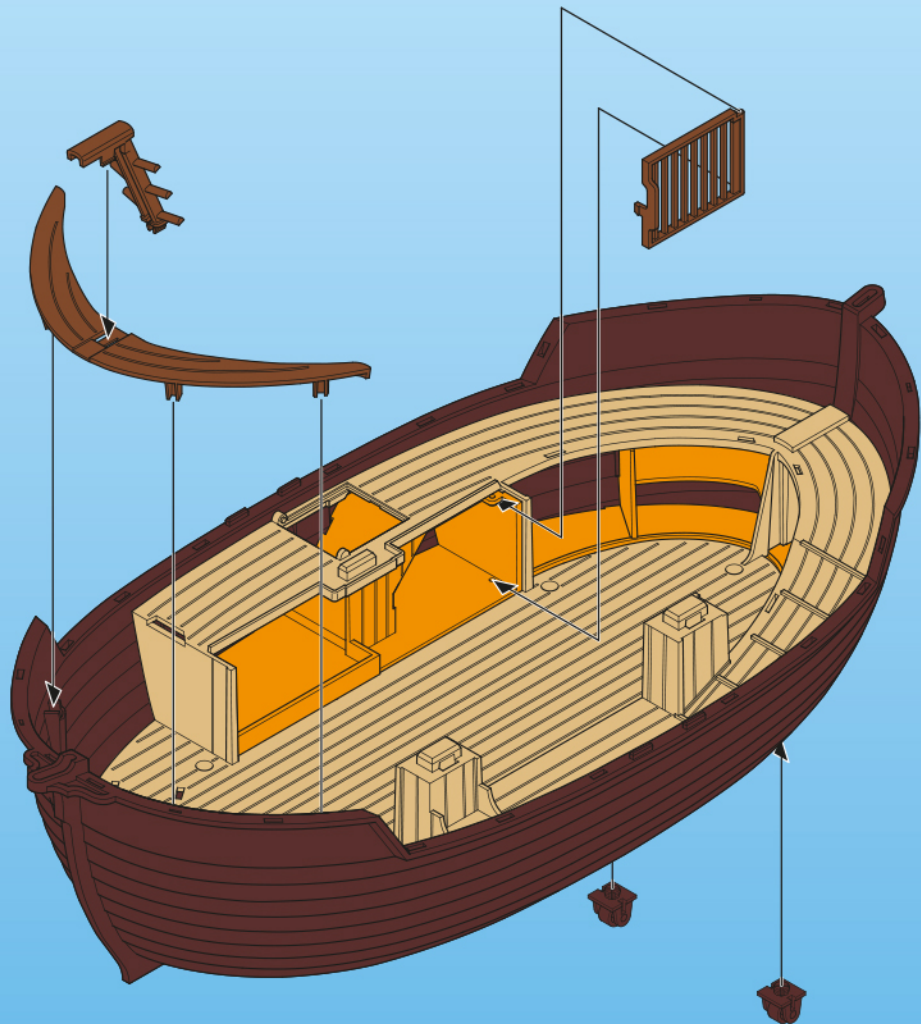

2

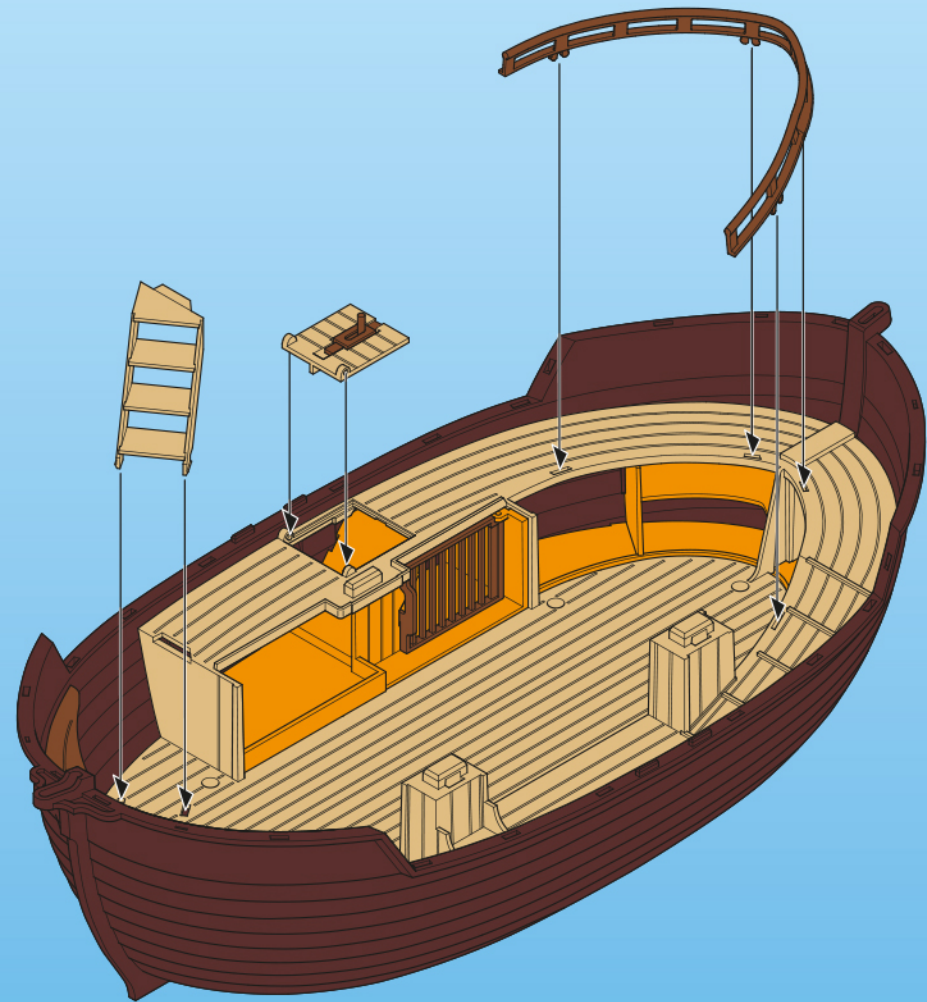
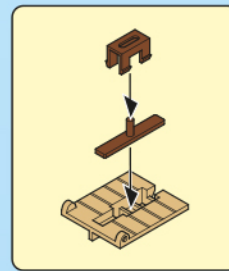

3

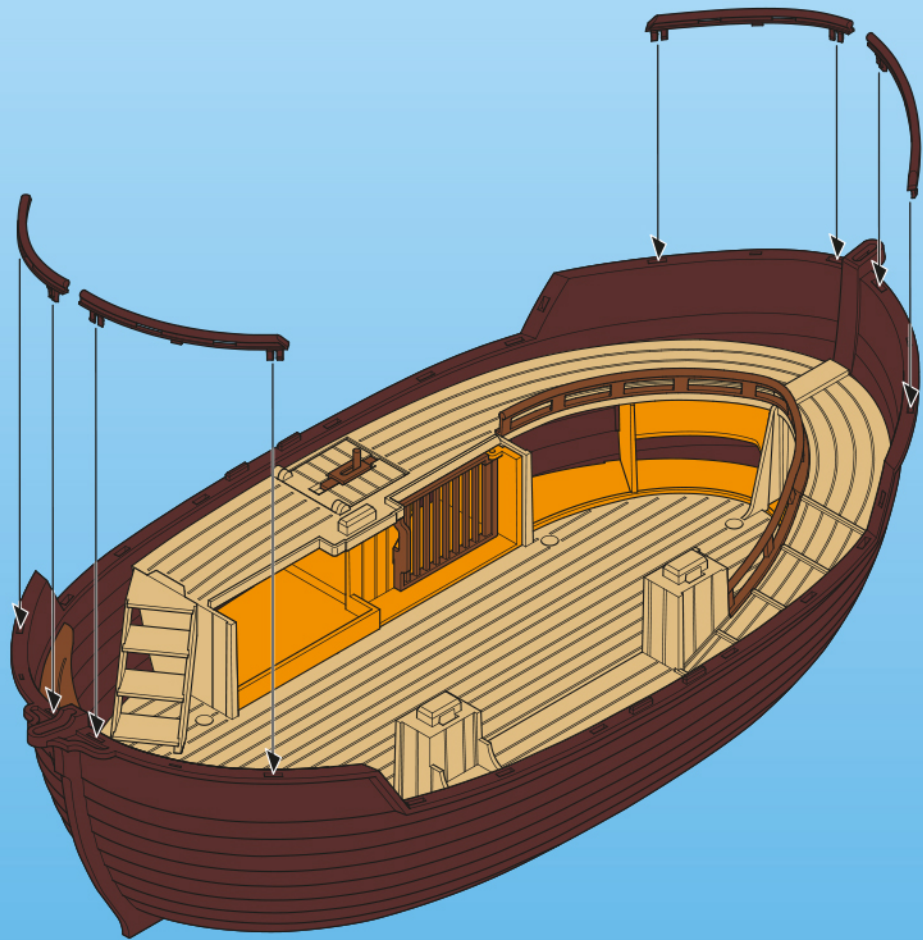

4

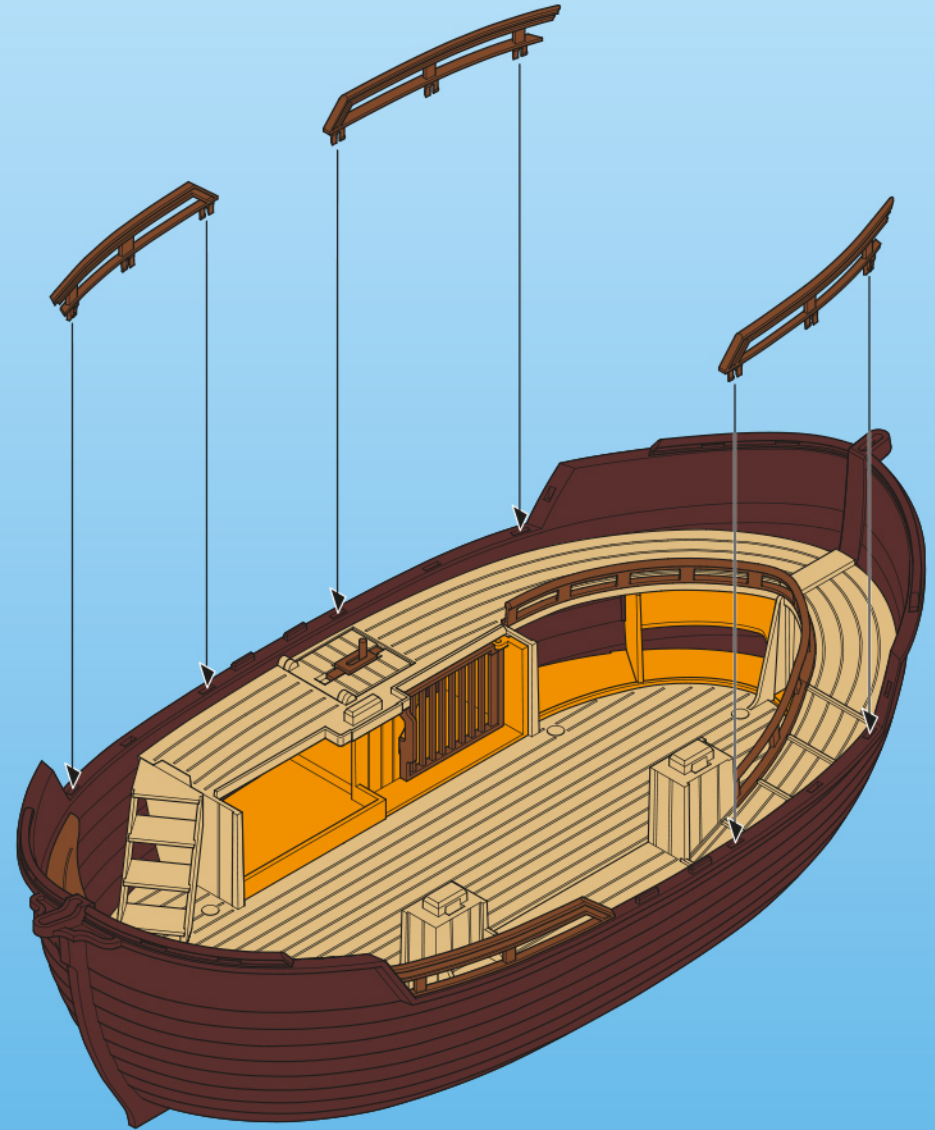

5

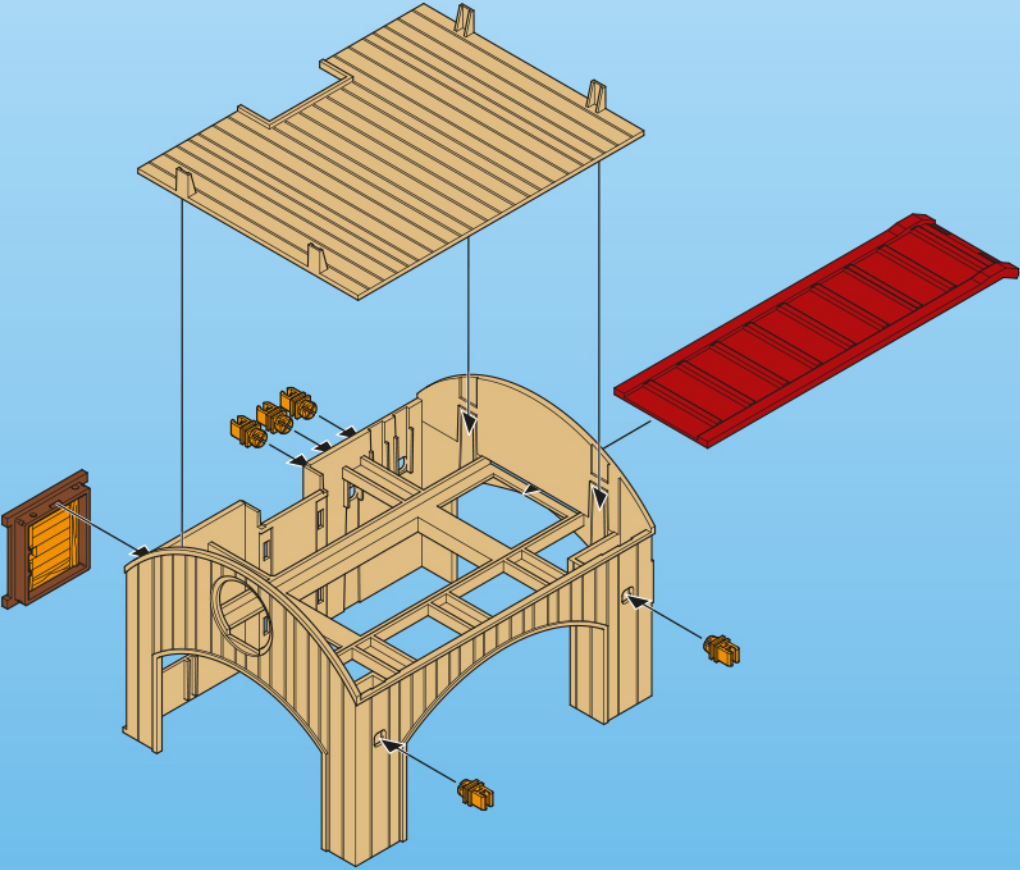
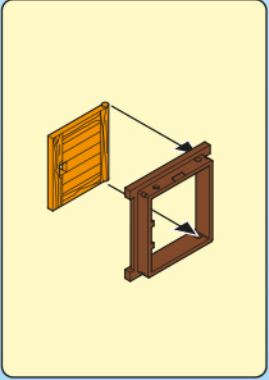

6

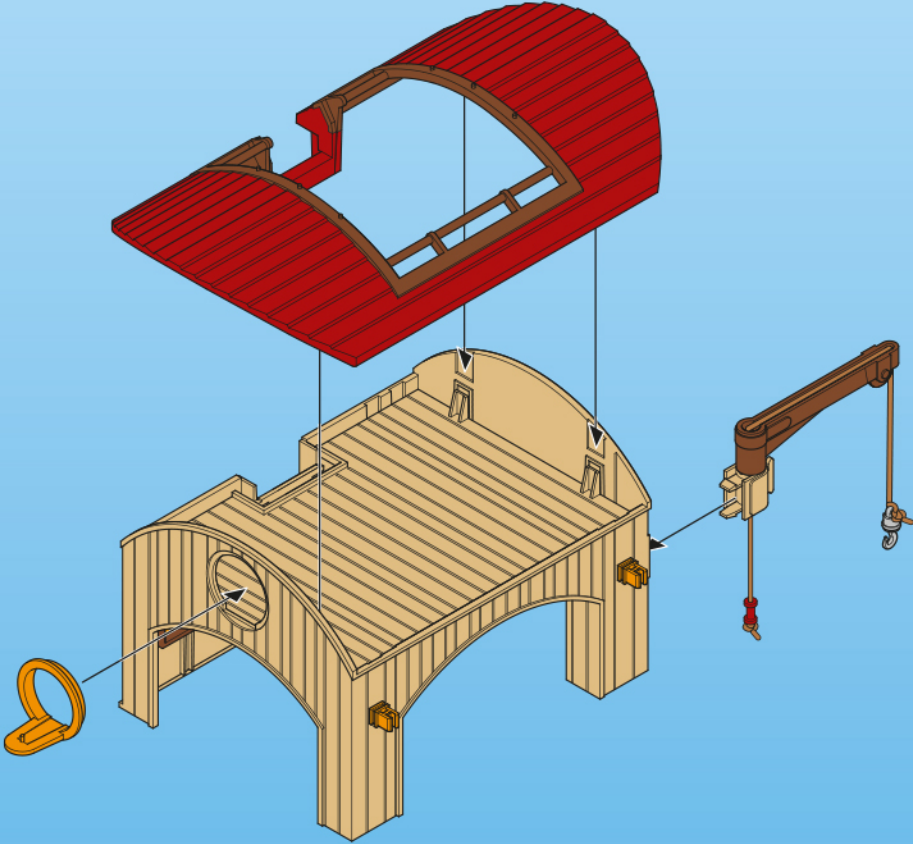
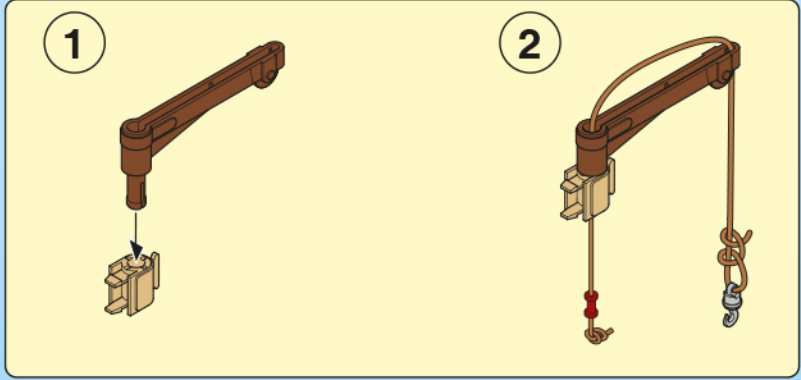

7

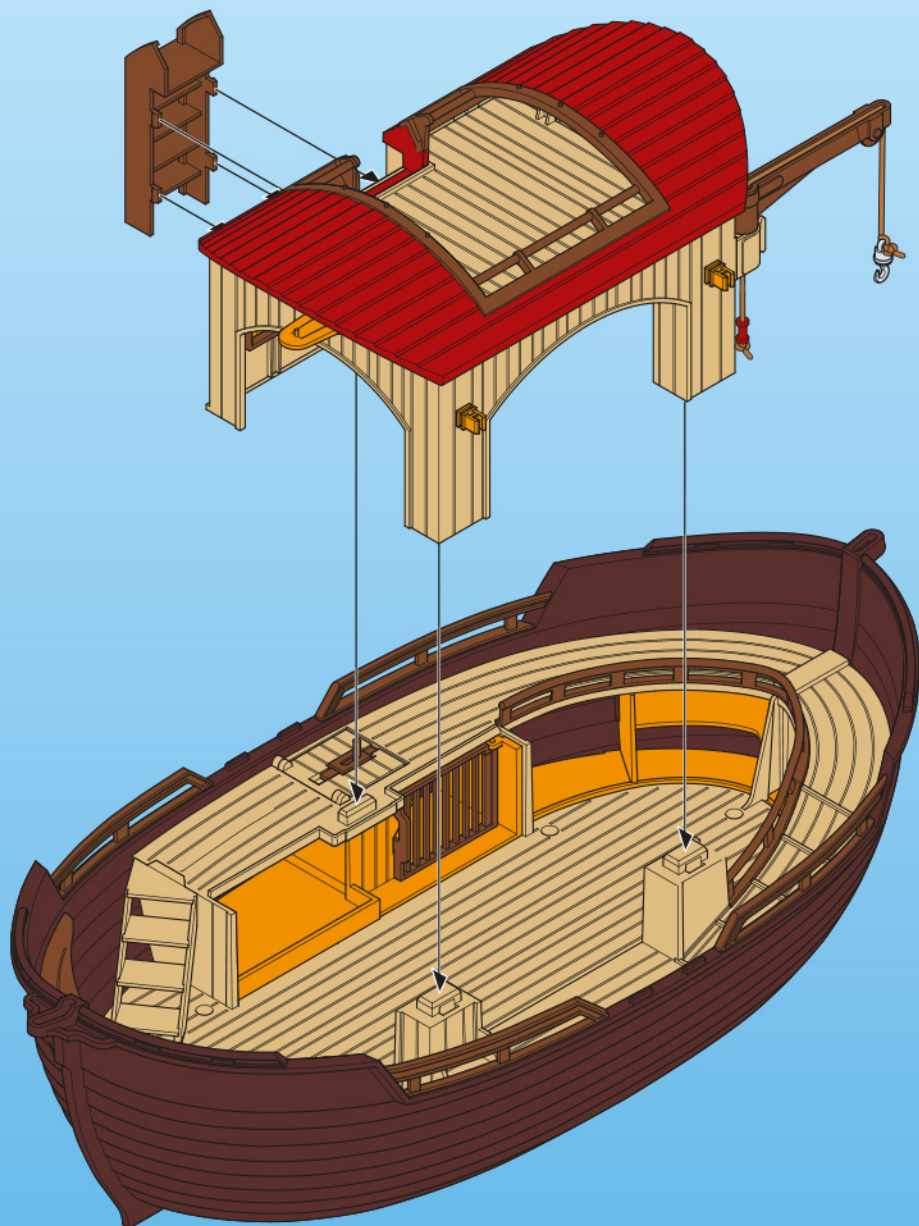

- (D) (A) (CH) (L) (B) Anbaumöglichkeiten des RC-UW-Motors finden Sie unter:
RC-Motor.playmobil.com
- (USA) (GB) (CDN) (M) (IRL) For RC UW motor attachment possibilities, visit:
RC-Motor.playmobil.com
- (F) (CDN) (B) (L) (CH) Vous trouverez des informations complémentaires sur le site
Internet: RC-Motor.playmobil.com
- (E) (MEX) Las posibilidades de montaje del motor submarino RC se pueden consultar
en: RC-Motor.playmobil.com
- (NL) (B) Aanbouwmogelijkheden van de RC-Onderwatermotor vindt u op: RC-Motor.playmobil.com
- (I) (CH) Le possibilità di montaggio del motore RC-UW sono descritte al sito:
RC-Motor.playmobil.com
- (P) As possibilidades de montagem do motor RC subaquático pode ser consultadas
em: RC-Motor.playmobil.com
- (DK) Montagemuligheder for RC-UW-motoren finder du på: RC-Motor.playmobil.com
- (N) Monteringsmuligheter for RC-UW-motoren finner du under: RC-Motor.playmobil.com
- (S) (FIN) RC-undervattensmotorns monteringsmöjligheter hittar du på: RC-Motor.playmobil.com
- (FIN) Vedenalaisen RC-mootorin asennusmahdollisuuksia löytyy osoitteesta:
RC-Motor.playmobil.com
- (H) Az RC-UW- Motor hozzáépítési lehetőségeiről az RC-Motor.playmobil.com alatt
talál anyagot.
- (CZ) Možnosti instalace lodního motoru s dálkovým ovládáním najdete na internetové
adrese RC-Motor.playmobil.com
- (EST) RC-UW-Motor'i paigaldusjuhised leiate aadressil: RC-Motor.playmobil.com
- (LV) Informāciju par RC-UVV motora montāžas iespējām skati vietnē: RC-Motor.playmobil.com
- (LT) RC UW variklio pritvirtinimo galimybes pateikiamos tokiame internetiniame
puslapyje: RC-Motor.playmobil.com
- (SLO) Možni načini namestitve daljinsko krmiljenega (RC) podvodnega (UW) motorja so na voljo
na naslovu: RC-Motor.playmobil.com
- (SK) Možnosti inštalácie lodného motora s diaľkovým ovládaním nájdete na internetovej
adrese RC-Motor.playmobil.com
- (PL) Możliwości zastosowania podwodnego silnika RC znajdują się na stronie:
RC-Motor.playmobil.com
- (TR) (CY) Uzaktan kumandalı su altı motorunun montaj kılavuzu RC-Motor.playmobil.com
sayfasında gösterilmiştir
- (GR) (CY) Οδηγίες συναρμολόγησης του τηλεκατευθυνόμενου μοτέρ με υπέρυθρες ακτίνες θα
βρείτε στην ηλεκτρονική διεύθυνση: RC-Motor.playmobil.com
- (RO) Posibilități de montare a motorului submersibil cu telecomandă se găsesc pe site-ul:
RC-Motor.playmobil.com
- (BG) Възможности за допълнително оборудване на RC-електромотора за под вода можете
да намерите на адрес: RC-Motor.playmobil.com
- (HR) Mogućnosti dogradnje RC-UW-Motora ćete pronaći pod: RC-Motor.playmobil.com
- (CN) 了解红外线水下电机的安装方法请访问以下网
站: RC-Motor.playmobil.com

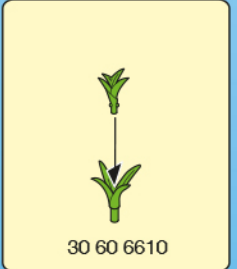
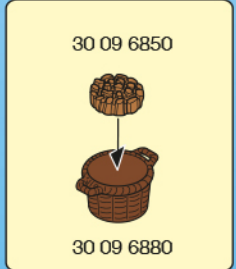
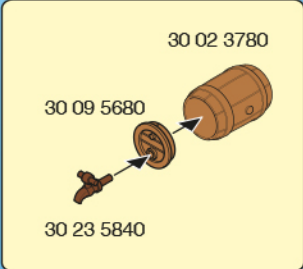
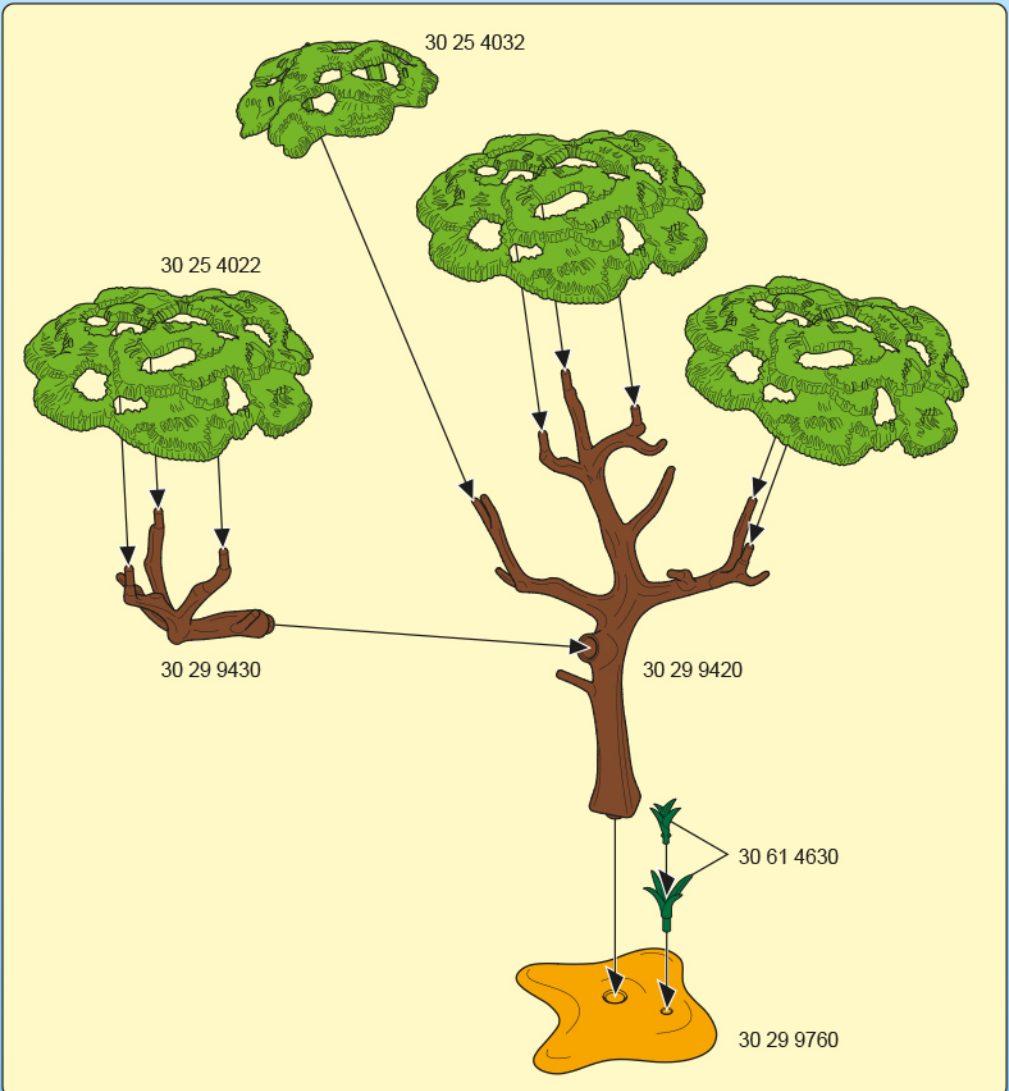

2x 30 83 0010



2x 30 83 0190



30 65 7162



30 83 0250



30 65 7152



30 83 0260



30 00 0242



30 14 2140

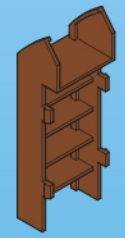

30 23 5970



30 23 6100



30 23 6020

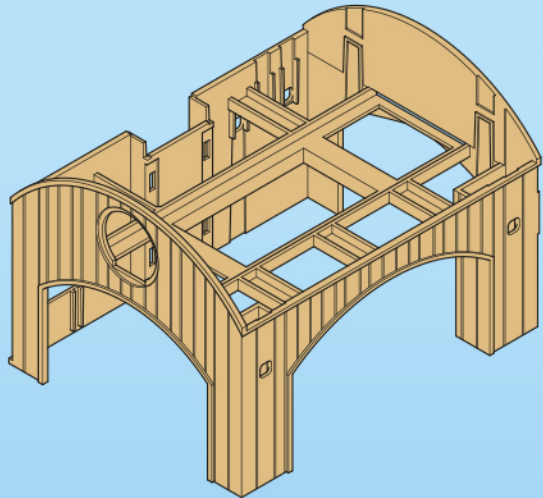

30 23 6000

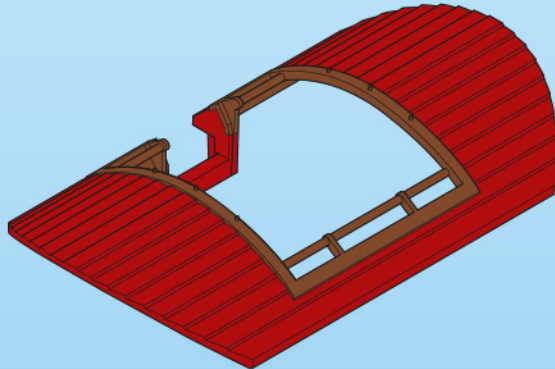

30 23 6040

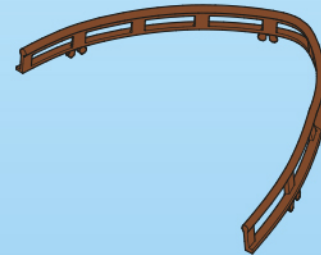

30 23 6060

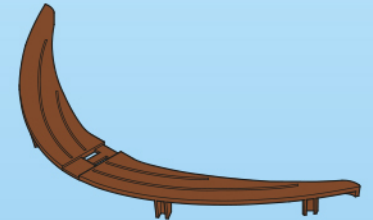

30 23 5980

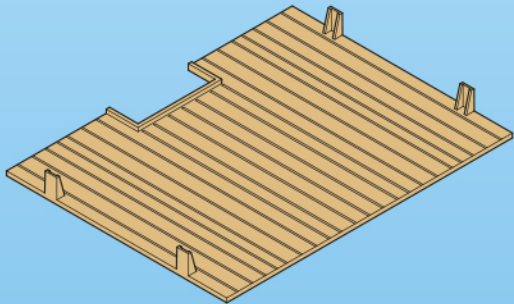

30 23 6050

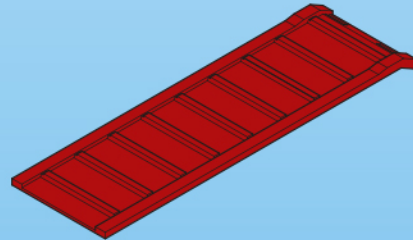

30 25 4012

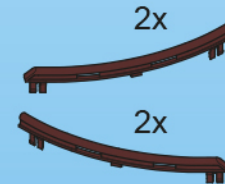

2x

2x

30 51 1632

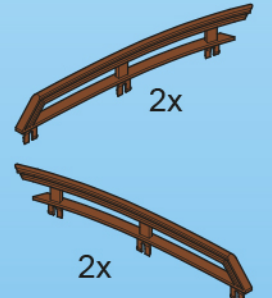

2x

2x

30 51 2170

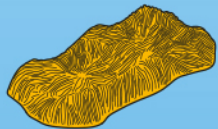

2x 30 23 6120



30 07 0940

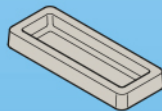

30 21 1730



30 23 5830



30 06 0020



30 05 8820



30 65 0220



30 23 5820



2x 30 04 1780



30 25 6530



30 23 8470



30 23 8460



30 26 1870



2x 30 09 6780



30 09 6840



2x 30 09 6830



2x 30 08 1260



30 80 0133



30 83 0350

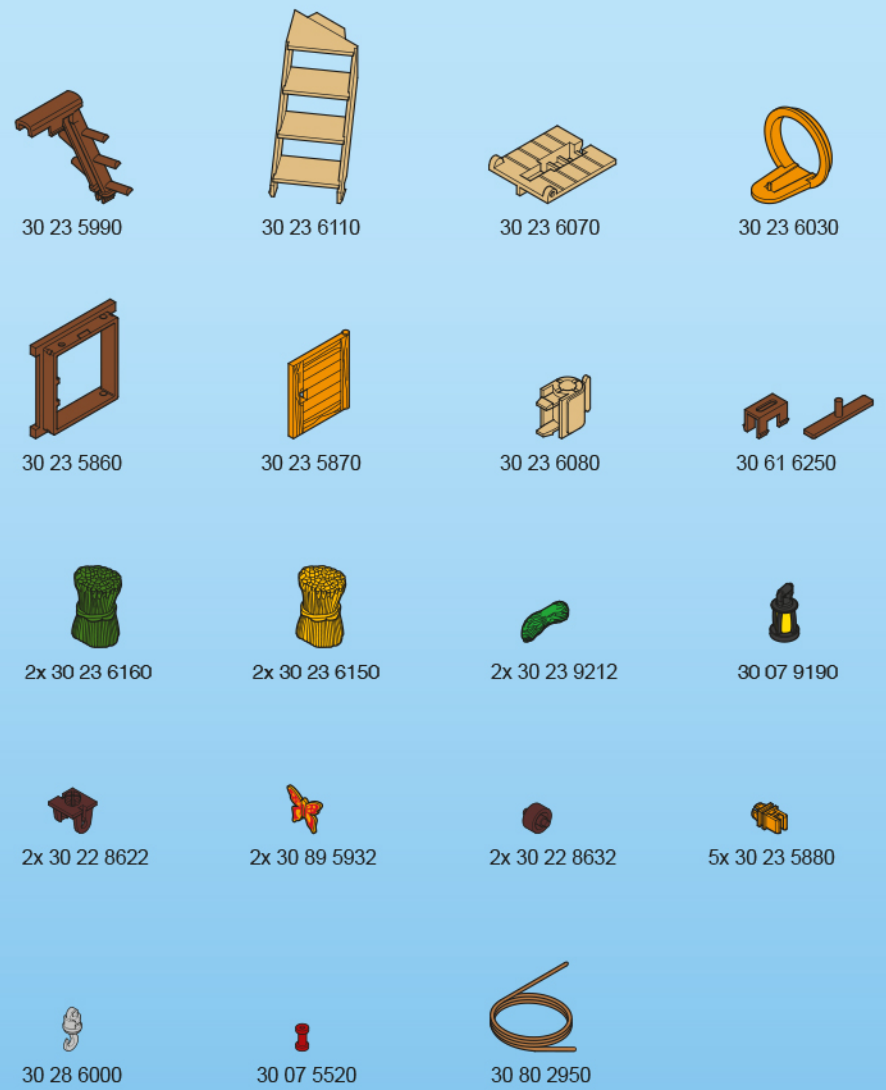
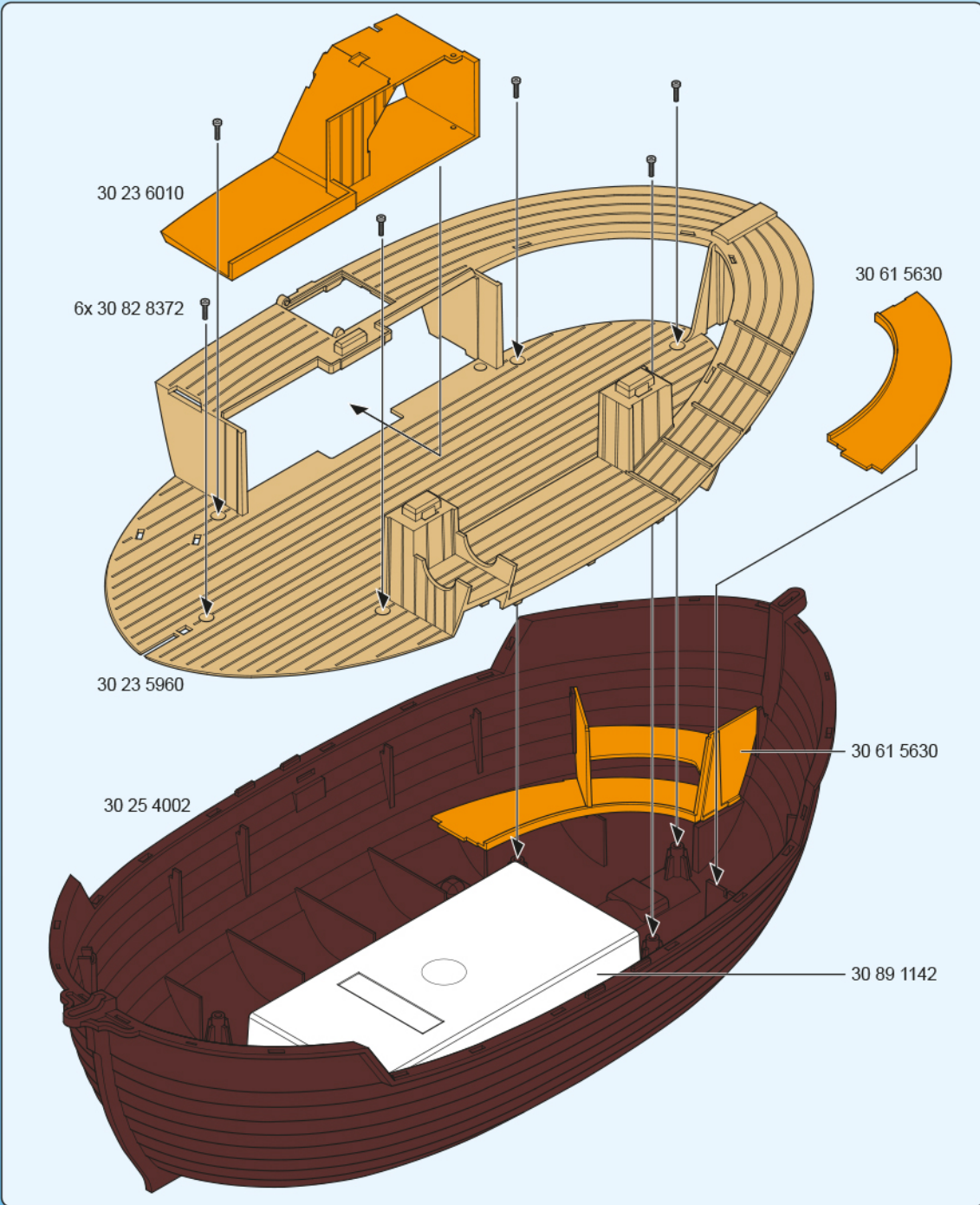

Serviceadressen finden Sie in allen Playmobil-Prospekten

Addresses of Customer Service Departments are shown in all Playmobil catalogues

L'adresse du service consommateurs est indiquée dans tous les catalogues Playmobil

Troverete gli indirizzi dei centri di assistenza in tutti i cataloghi Playmobil

In alle PLAYMOBIL catalogi vindt u het adres van onze klantendienst.

Las Direcciones de los Departamentos de Servicio al Consumidor se encuentran en todos los catálogos Playmobil

Η διεύθυνση του Γραφείου Εξυπηρέτησης Πελατών είναι καταχωρημένη σε όλους τους καταλόγους Playmobil

pronounce: plāy-mō-bēil