

playmobil®
4139



WARNING:
CHOKING HAZARD

Small parts. Not for children under 3 years.

"Ne concerne que les USA"

Wichtige Unterlagen, bitte sorgfältig aufbewahren!
Important documents keep carefully!
Documents importants conservez avec soin!
Belangrijke documenten, bewaar deze zorgvuldig!



1

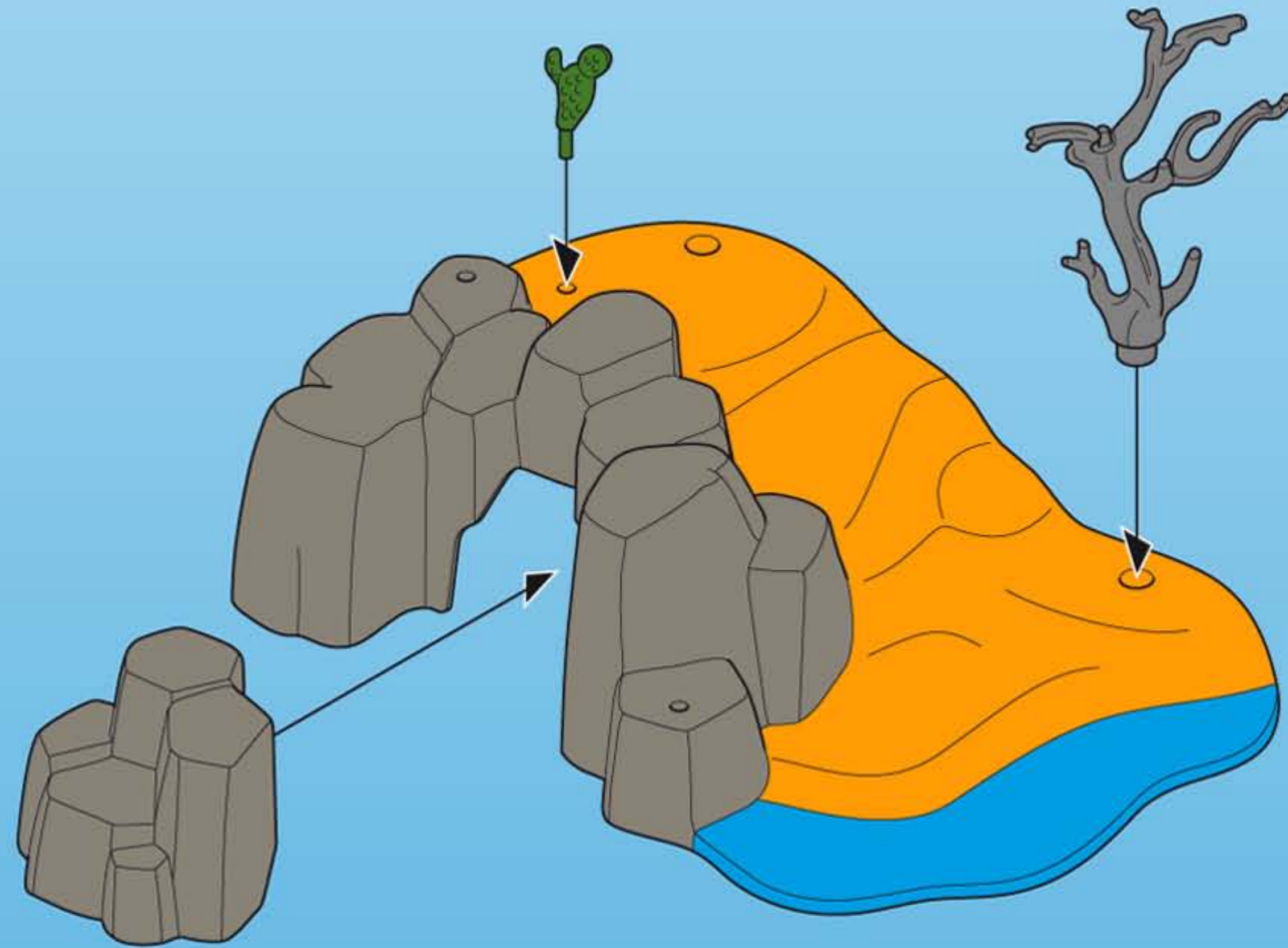

2

2



3

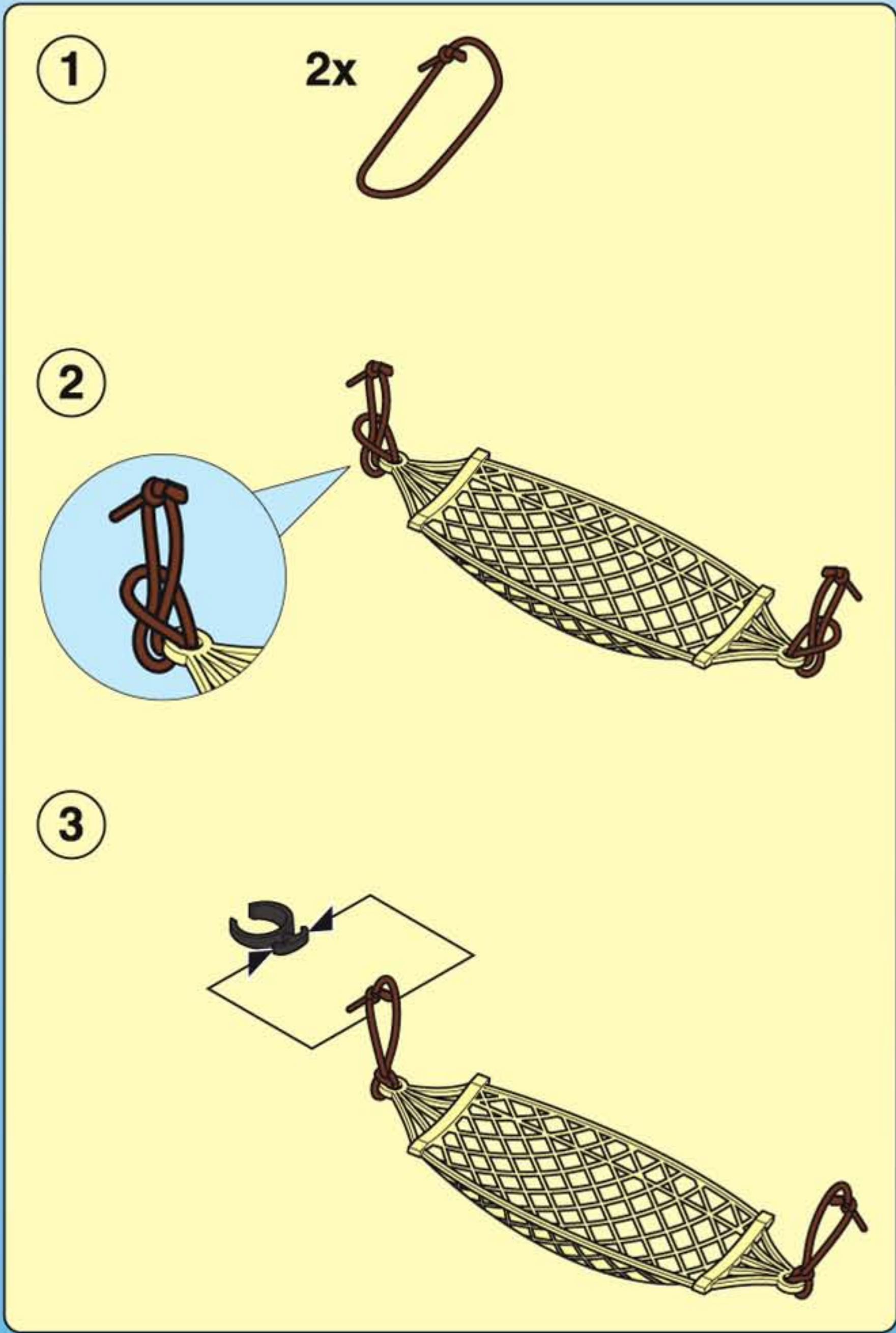

4

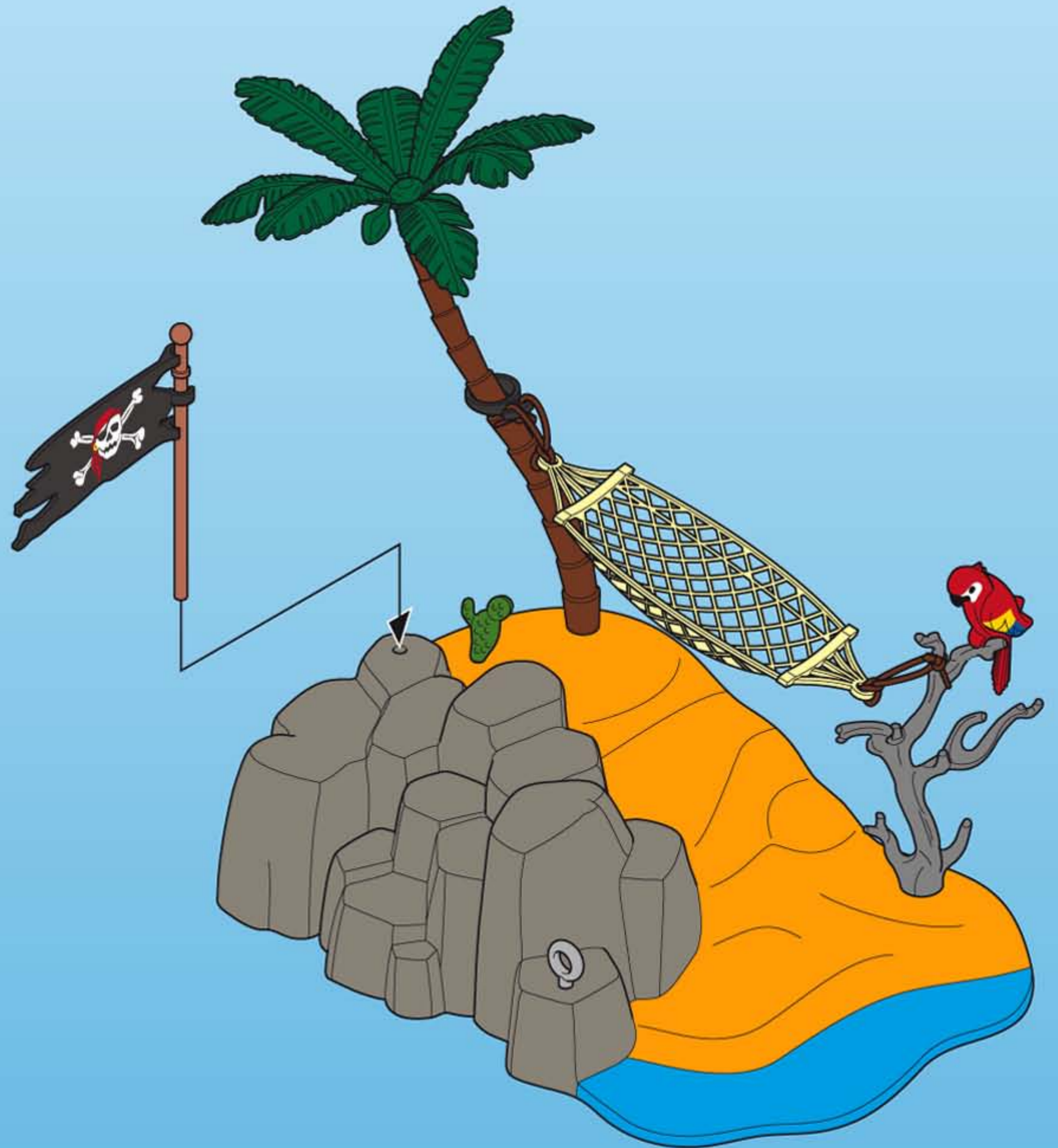

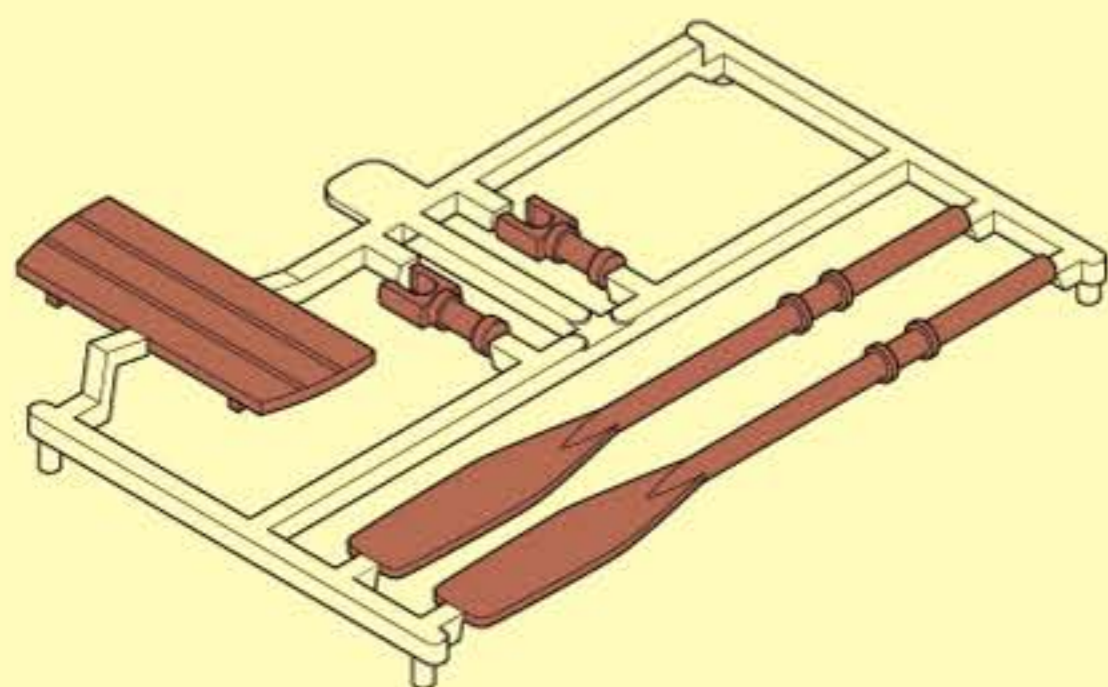

30 60 8150

1

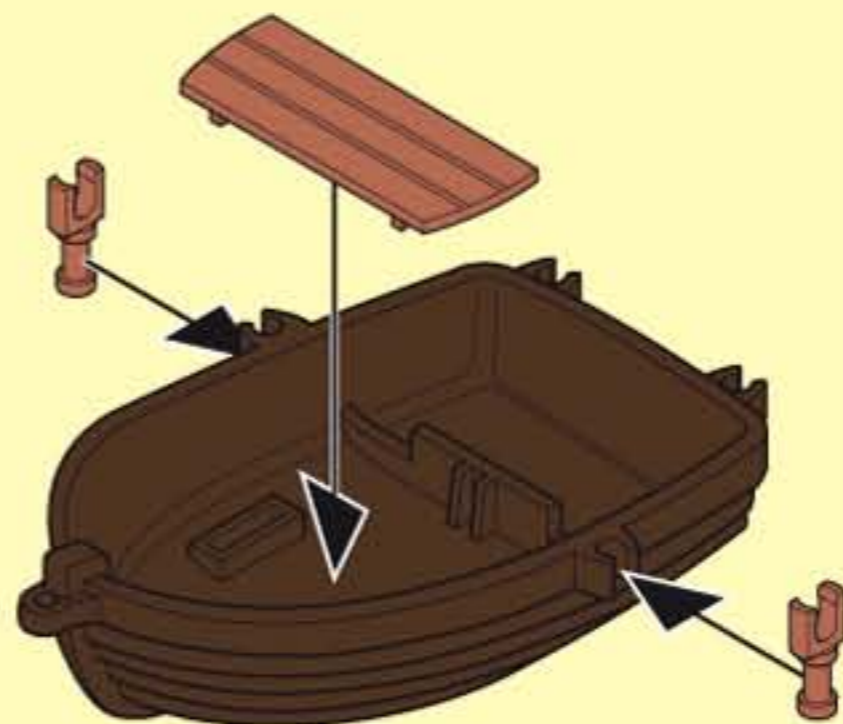

30 05 8060

2

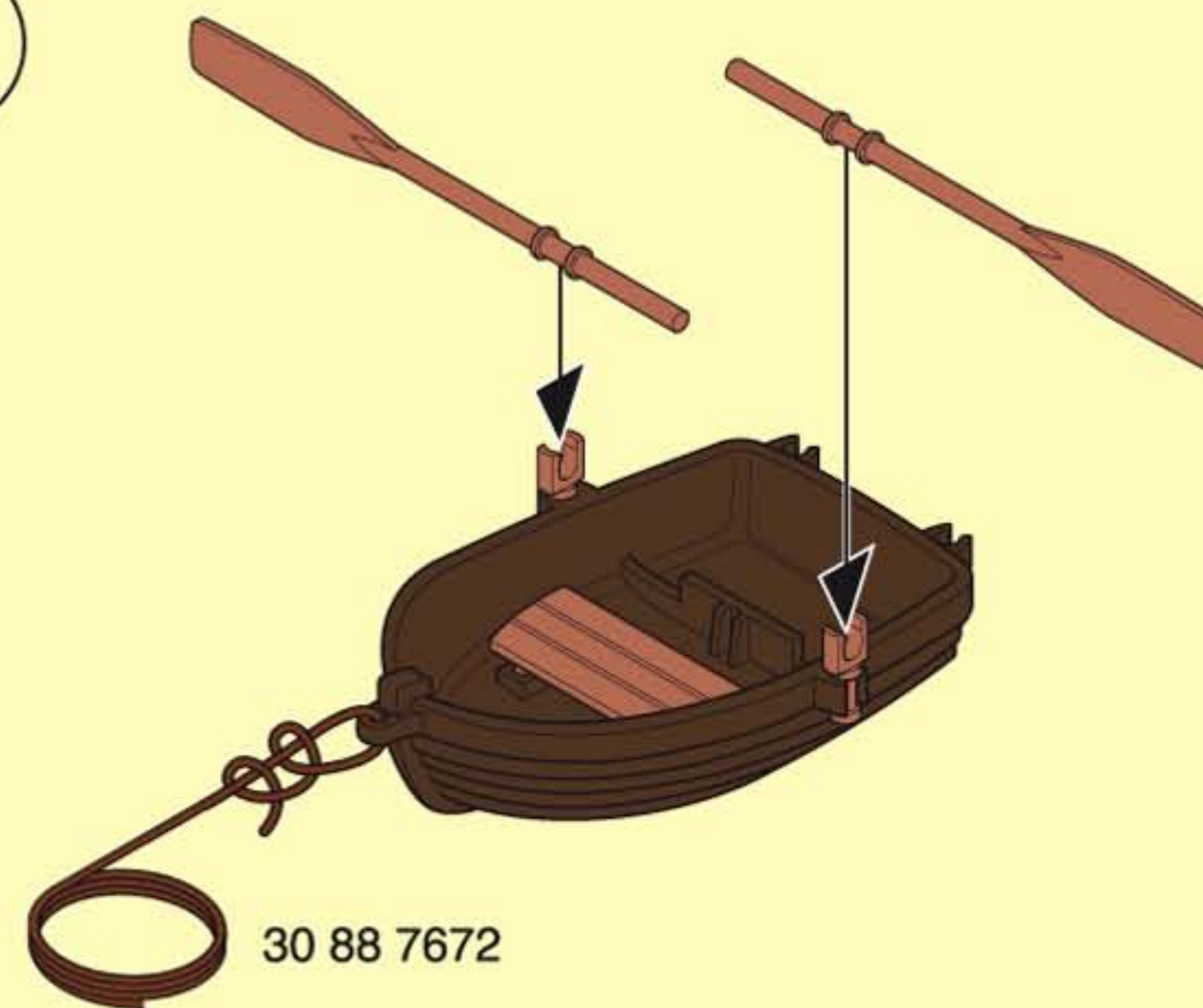

30 88 7672

(D) (A) (CH) (L) (B) ACHTUNG! Nur unter Aufsicht und nur in flachem Wasser benutzen.

(USA) (GB) (CDN) (M) (IRL) WARNING! Only to be used in water in which the child is within depth and under supervision

(F) (CDN) (B) (L) (CH) ATTENTION! À n'utiliser qu'en eau où l'enfant a pied et sous surveillance.

(E) (MEX) | ADVERTENCIA! Se deberá utilizar solamente en el agua, donde el niño haga pie y bajo vigilancia.

(NL) (B) WAARSCHUWING! Alleen gebruiken onder toezicht, in water waarin het kind kan staan.

(I) (CH) ATTENZIONE! Utilizzare solo in acque dove il bambino tocca con i piedi e sotto sorveglianza.

(P) AVISO! Utilizar apenas em águas em que a criança tenha pé e sob vigilância.

(DK) ADVARSEL! Må kun anvendes under opsyn og på vanddybder, hvor barnet kan bunde.

(N) ADVARSEL! Skal kun brukes i vann som ikke er for dypt for barnet, og der barnet er under tilsyn.

(S) (FIN) VARNING! Får endast användas på grunt vatten och under uppsikt av vuxen.

(FIN) VAROITUS! Käytetään ainoastaan matalassa vedessä, jossa lapsi voi seistä ja on aikuisen valvonnassa.

(H) FIGYELMEZTETÉS! Mély vízben nem használható! Kérjük, kizárólag szülői felügyelettel használja kis vízben!

(CZ) VAROVÁNÍ! Používat pouze v mělké vodě a pod dohledem!

(EST) HOIATUS! Kasutamiseks ainult vees, kus lapse jalad ulatuvad põhja ja täiskasvanu järelevalve all.

(LV) BRĪDINĀJUMS! Lietojams tikai sekļā ūdenī un uzraudzībā.

(LT) DĖMESIO! Naudoti prižiūrint suaugusiesiems ir tokiame gylyje, kur vaikas gali stovėti.

(SLO) OPOZORILO! Uporabljeni samo v plitvi vodi in pod nadzorom.

(SK) UPOZORNENIE! Používať len vo vode primerane hĺbokej dieťaťu a pod dohľadom.

(PL) UWAGA! Tylko do użytku w wodzie płytkiej i pod nadzorem.

(TR) (CY) ΔΙΚΚΑΤ! Sadece denetim altında ve sadece alçak sularda kullanın.

(GR) (CY) ΠΡΟΣΟΧΗ! Να χρησιμοποιείται μόνο σε νερά όπου πατώνει το παιδί και κάτω από επίβλεψη.

(RO) AVERTIZARE! Se folosește doar sub supraveghere și doar în apă mică.

(BG) ПРЕДУПРЕЖДЕНИЕ! Да се използва само под наблюдение и в плитки води.

(CN) 警告! 可供孩子在水中使用，但必须在有人监护的情况下。

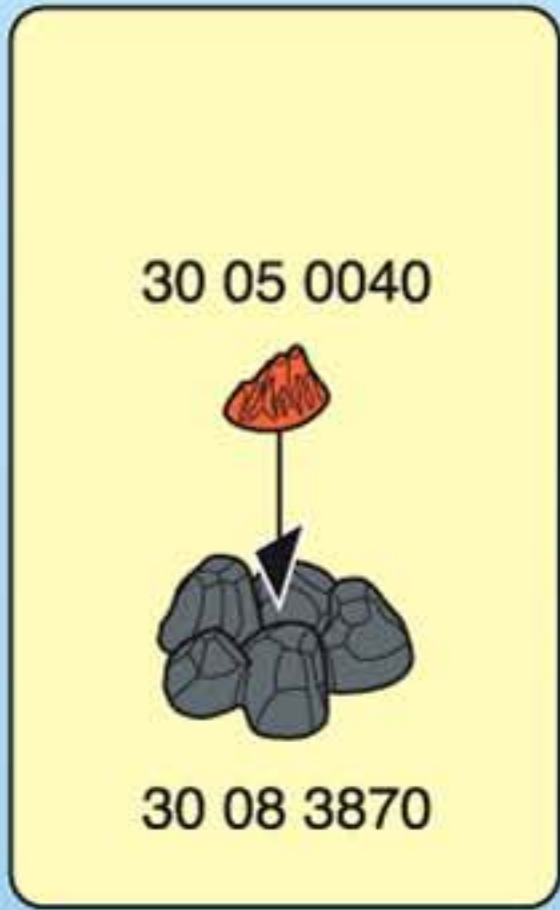

30 02 6020



30 00 4662

30 88 4932



30 10 2270

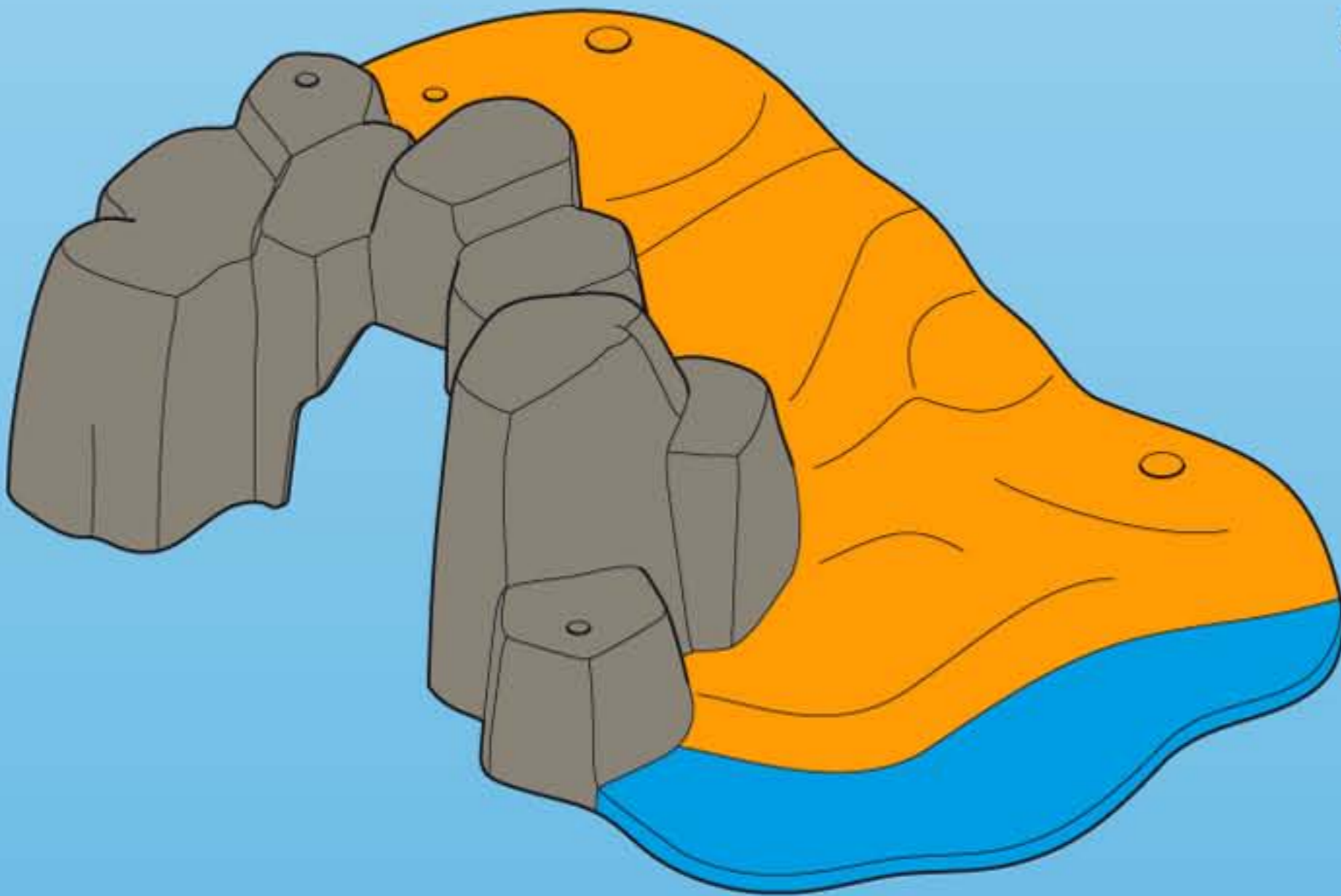

30 63 8812

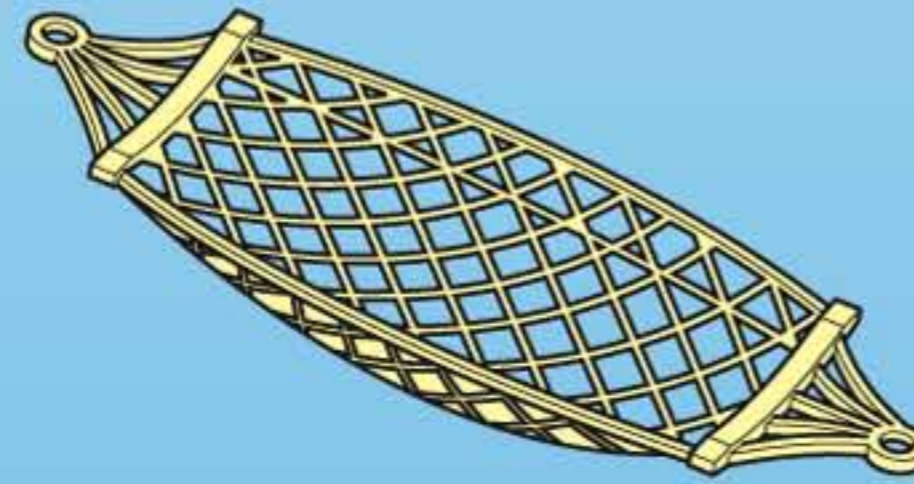

30 06 5800

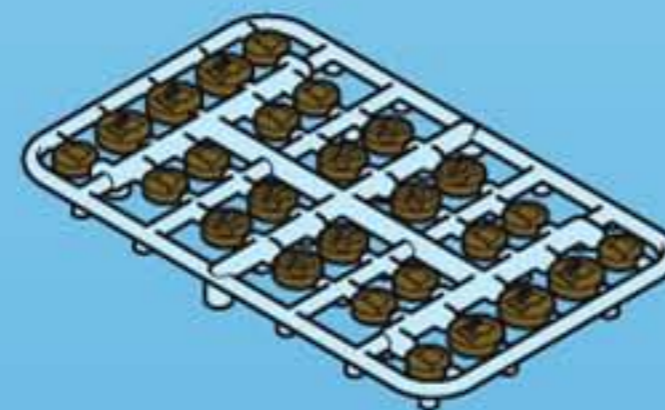

30 61 3730



30 28 4370



30 25 9290



30 21 9240



30 63 8792



30 20 5680



2x 30 88 7672



30 28 4830



30 21 9230



30 21 9250



30 83 0350



30 21 5520



30 09 7060



30 09 5340



30 24 1990

Serviceadressen finden Sie in allen Playmobil-Prospekten	In alle PLAYMOBIL catalogi vindt u het adres van onze klantendienst.
Addresses of Customer Service Departments are shown in all Playmobil catalogues	Las Direcciones de los Departamentos de Servicio al Consumidor se encuentran en todos los catálogos Playmobil
L'adresse du service consommateurs est indiquée dans tous les catalogues Playmobil	Η διεύθυνση του Γραφείου Εξυπηρέτησης Πελατών είναι καταχωρημένη σε όλους τους καταλόγους Playmobil
Troverete gli indirizzi dei centri di assistenza in tutti i cataloghi Playmobil	pronounce: plāy-mō-bēēl