

playmobil®

4073

WARNING:
CHOKING HAZARD
Contains a small ball and small parts.
Not for children under 3 years.

Ne concerne que les USA

Wichtige Unterlagen, bitte sorgfältig aufbewahren!
Important documents keep carefully!
Documents importants conservez avec soin!



1

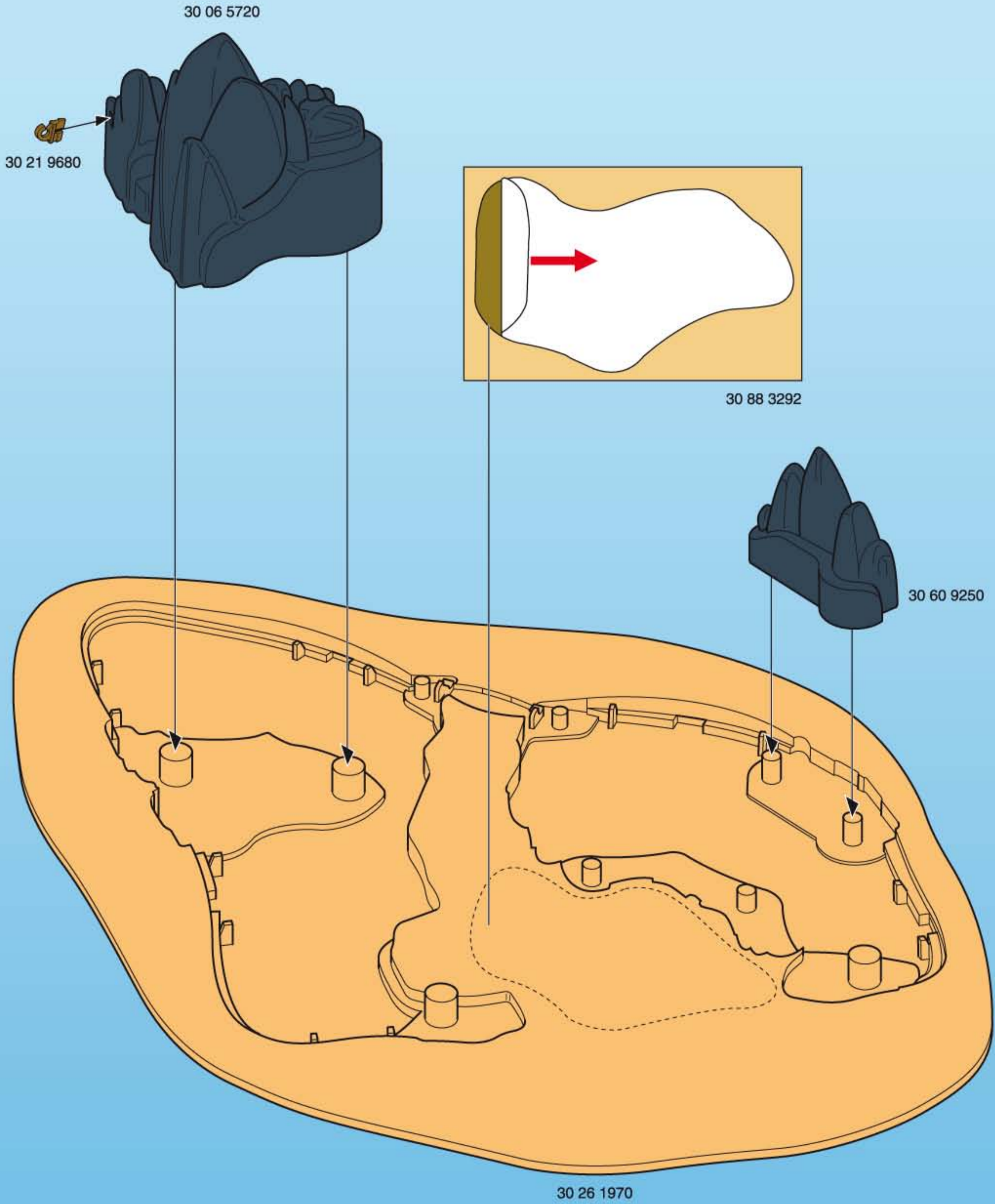

2

1

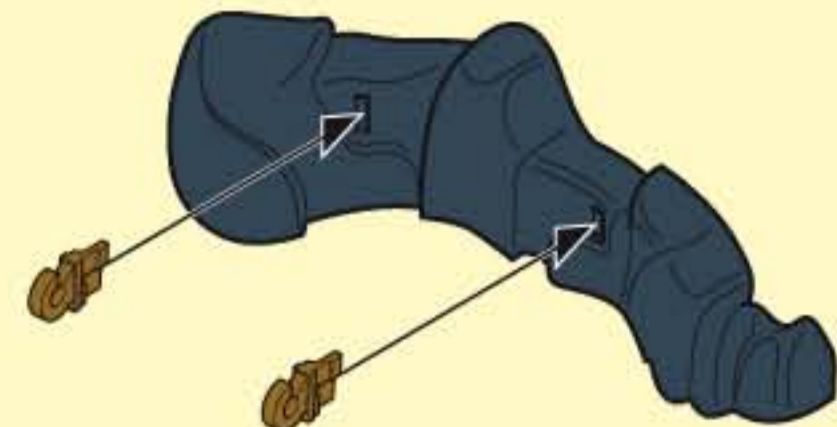

30 60 9250

2

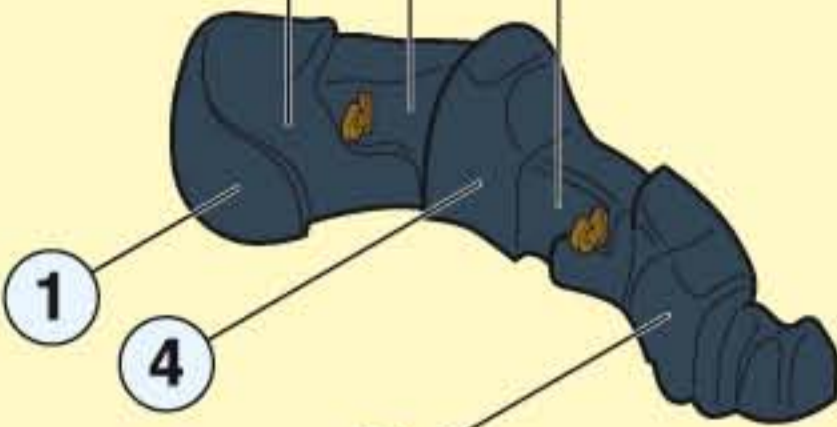

30 88 3302

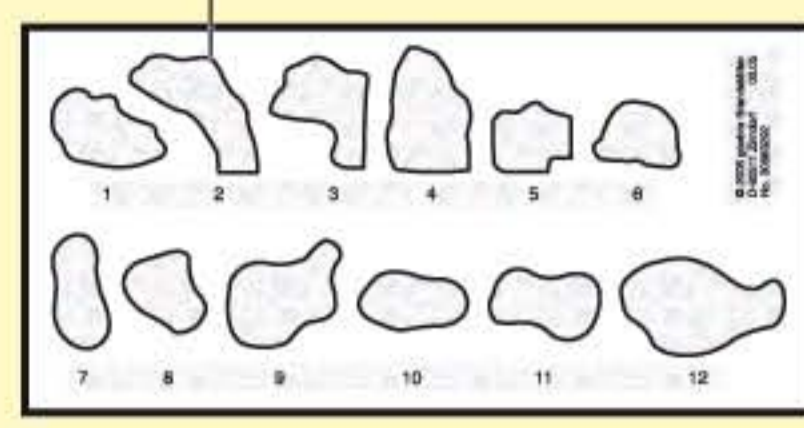

1 2 3 4 5 6
7 8 9 10 11 12

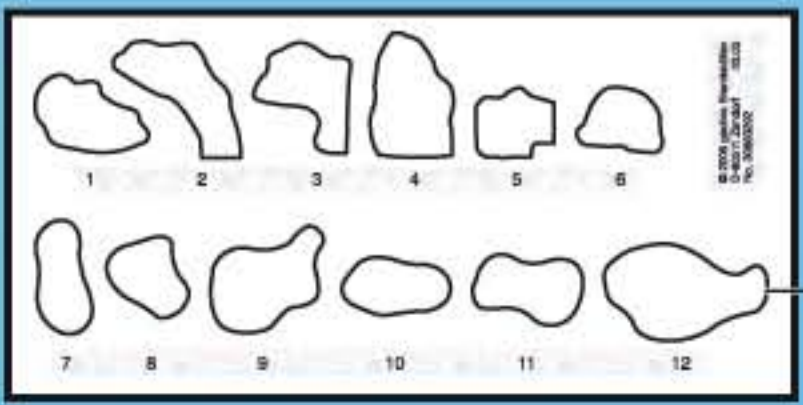
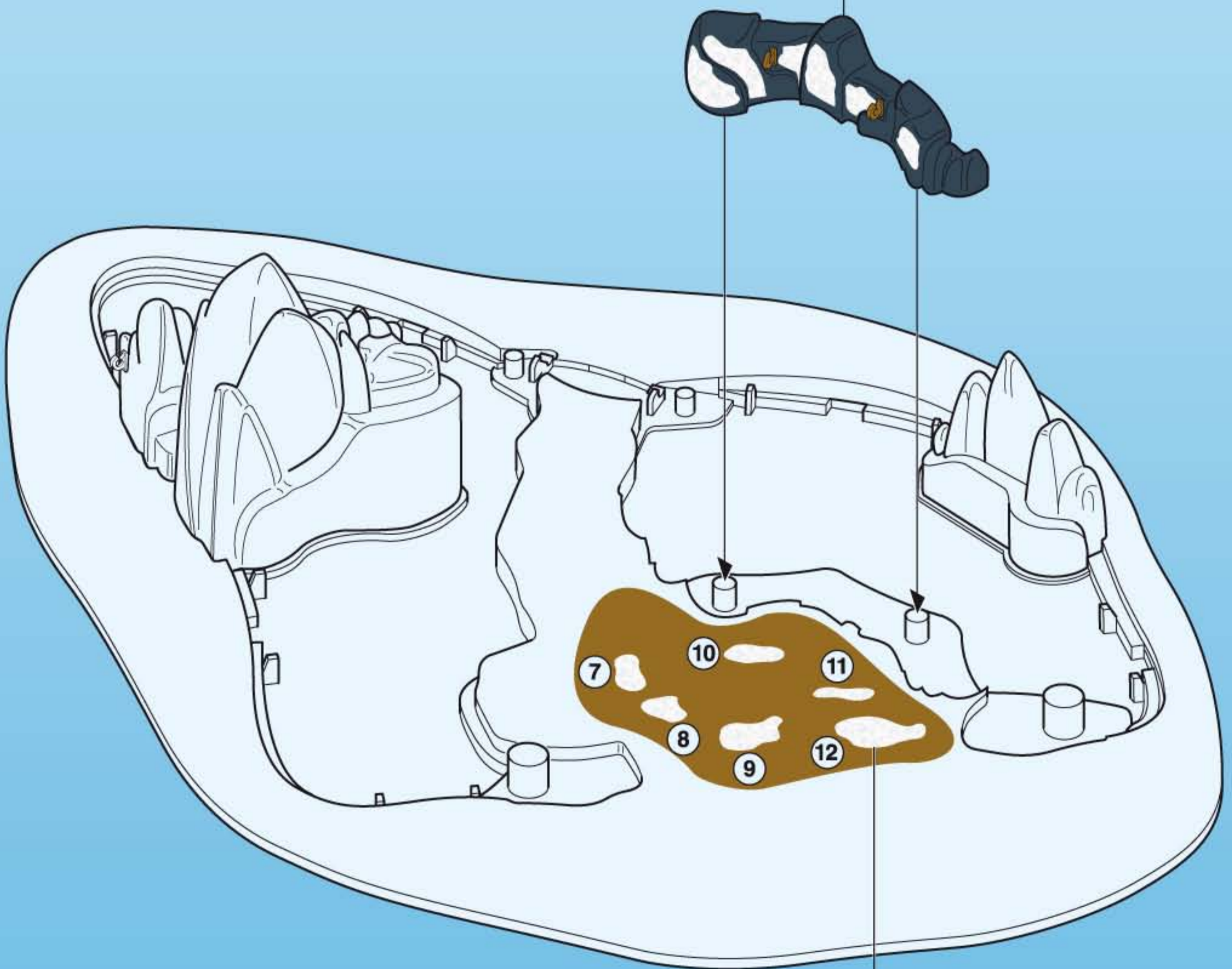

3

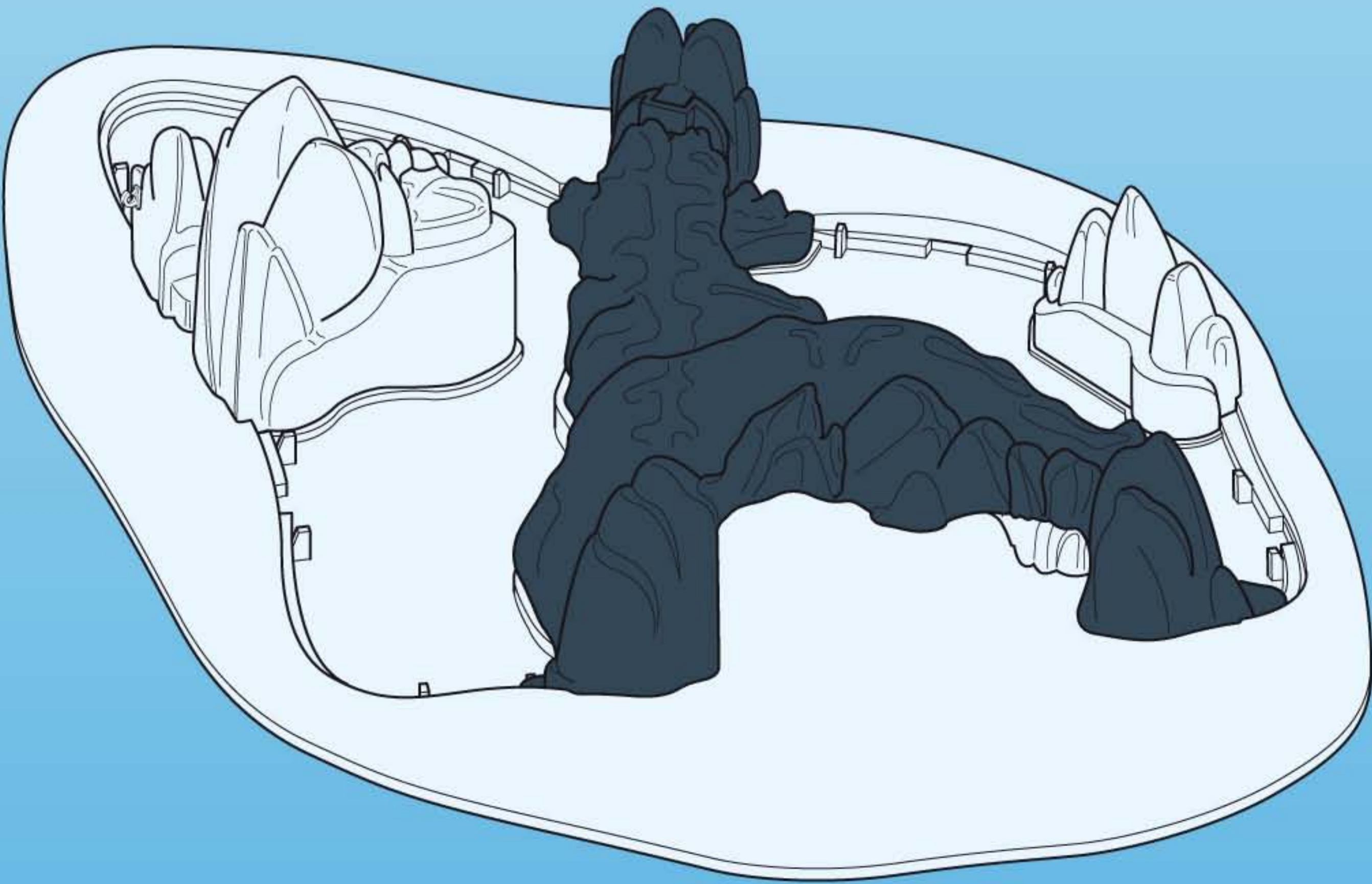
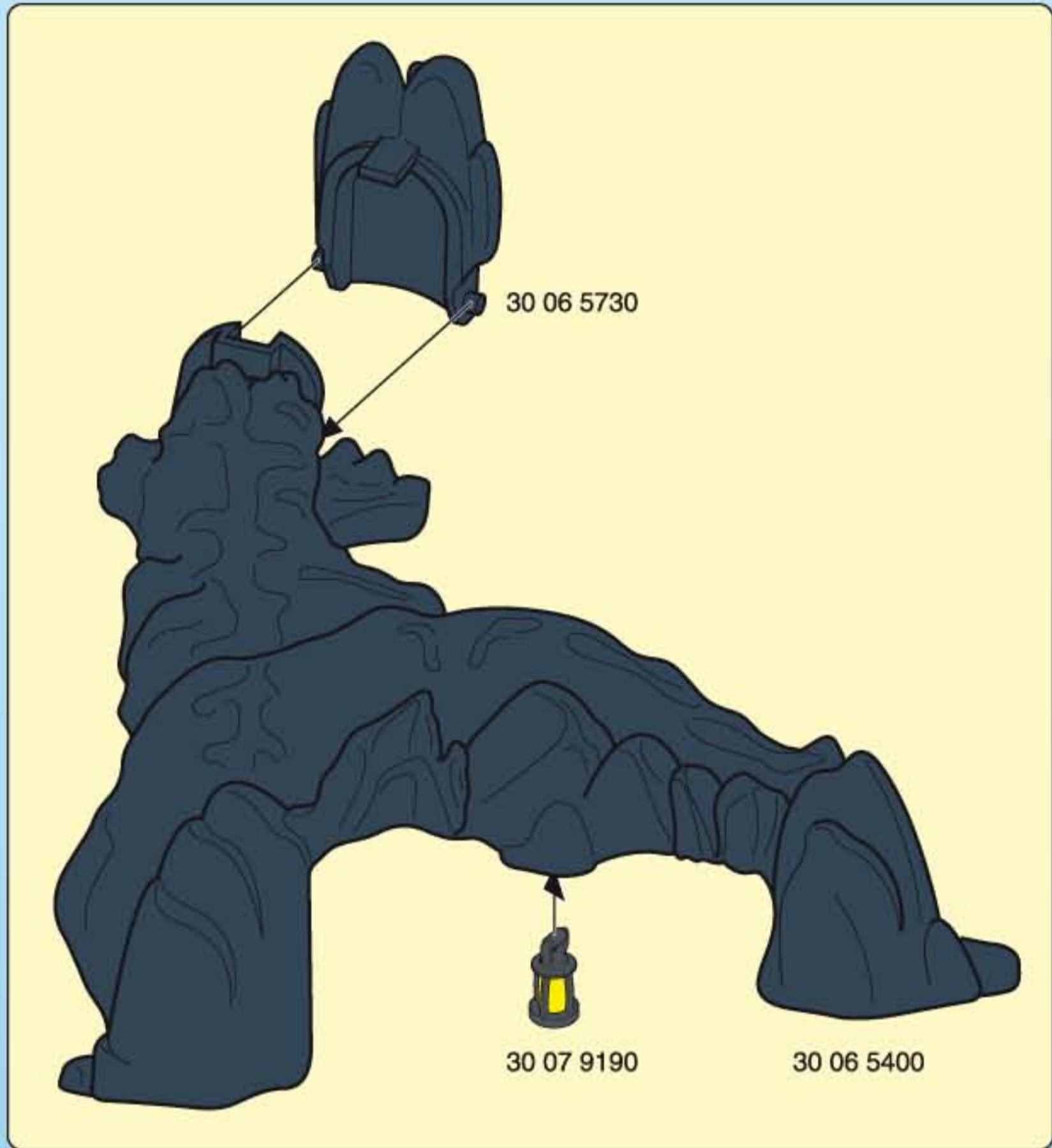

4

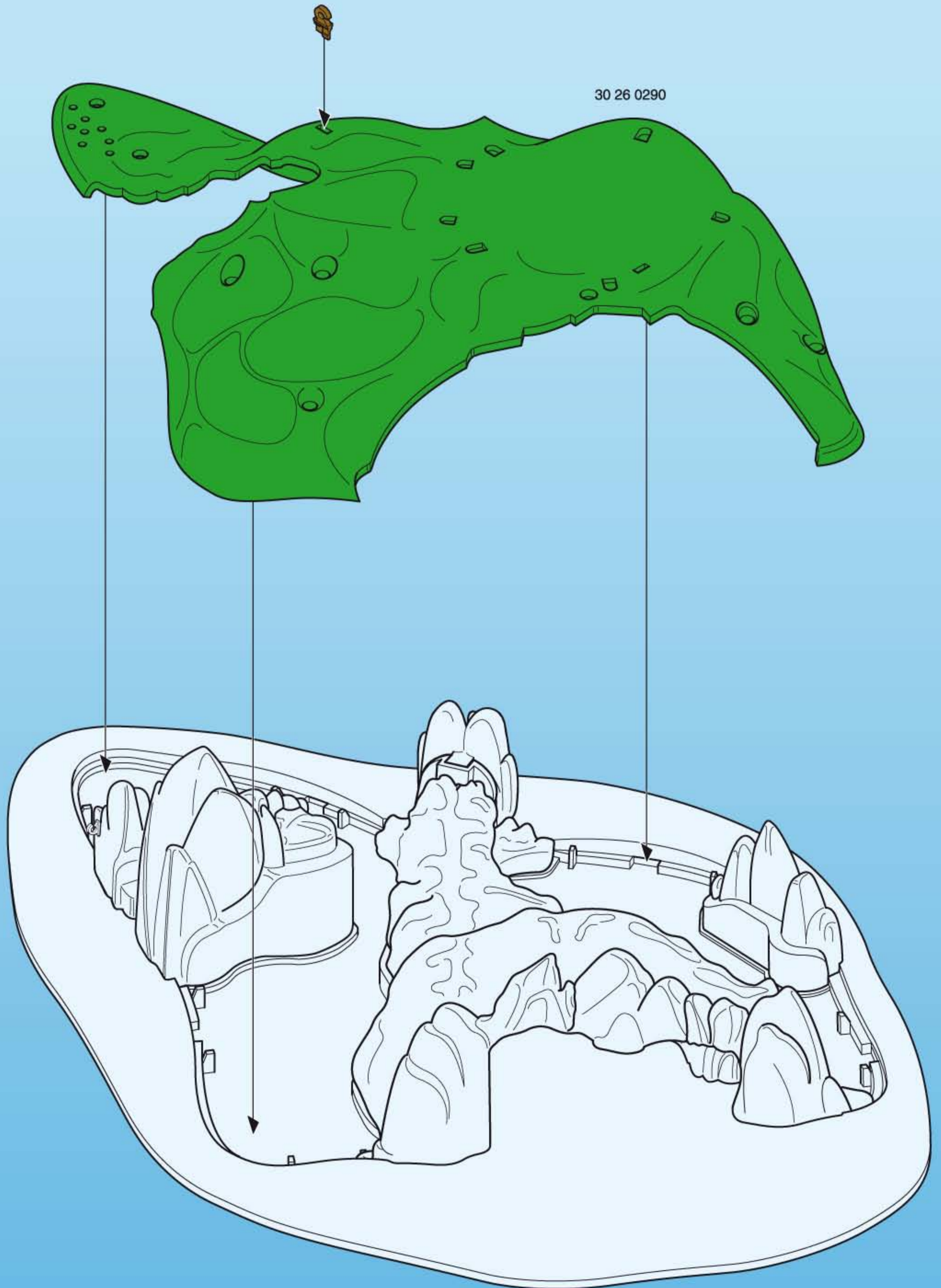

1

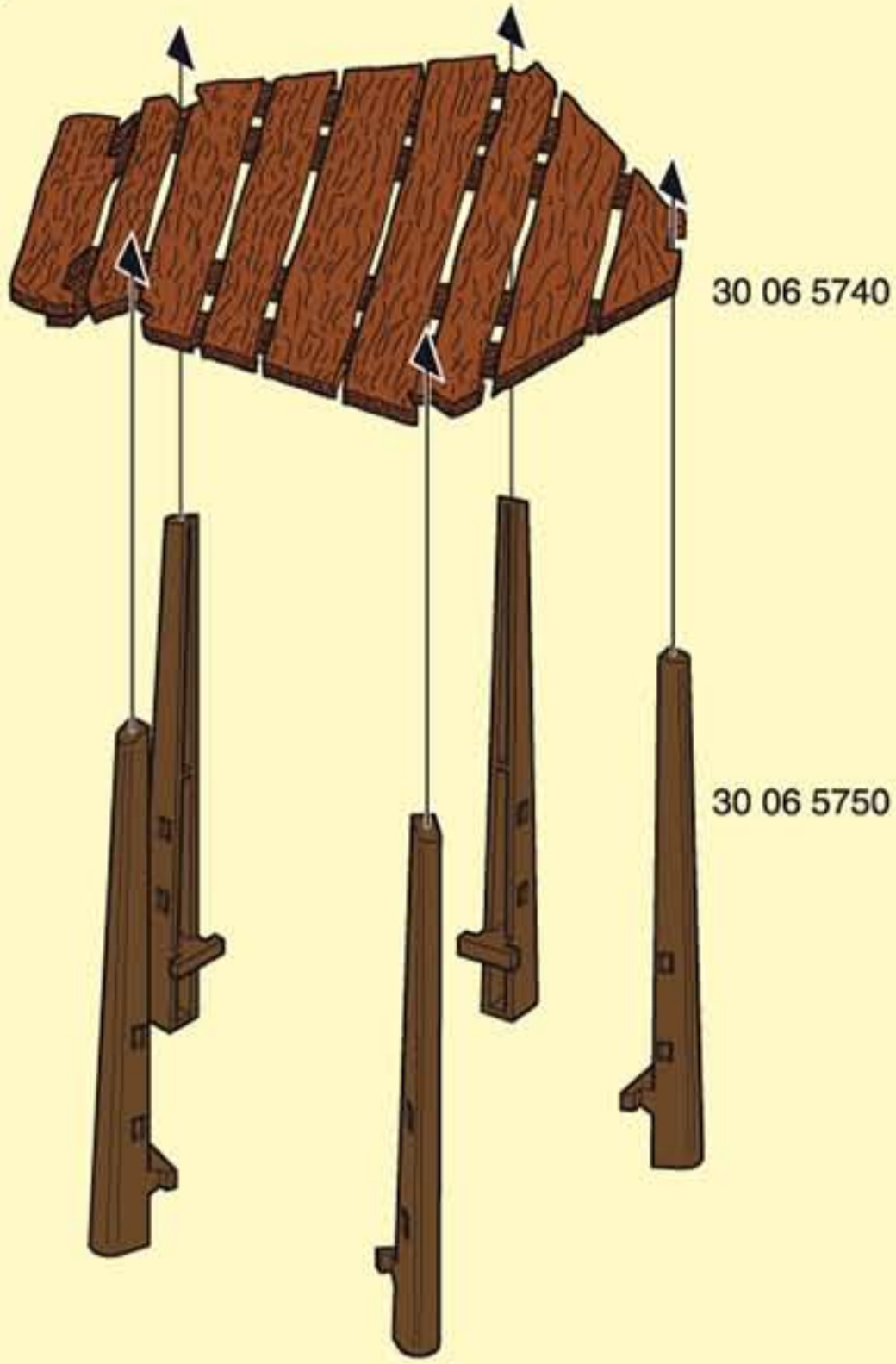

2

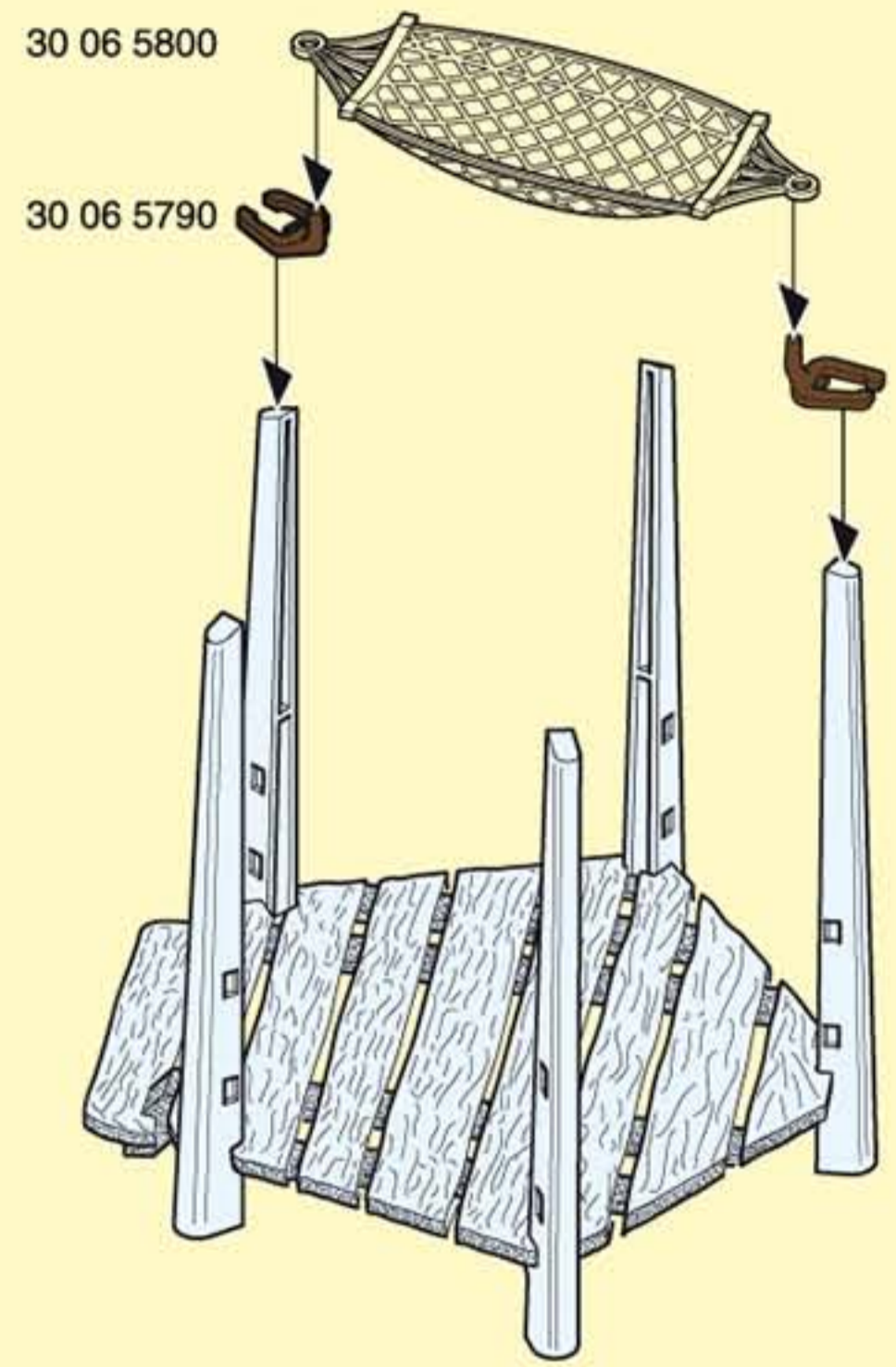

6

3

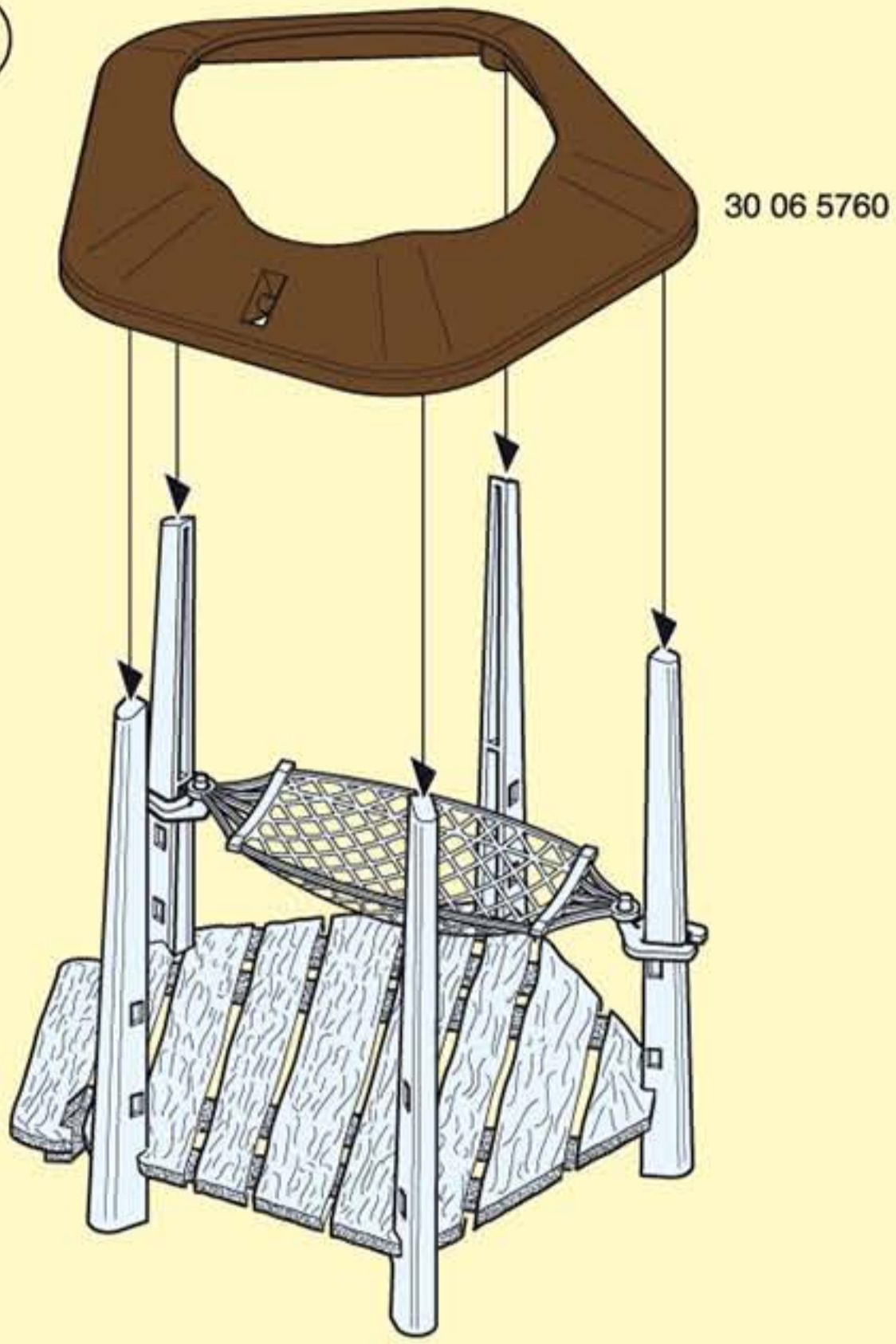

4

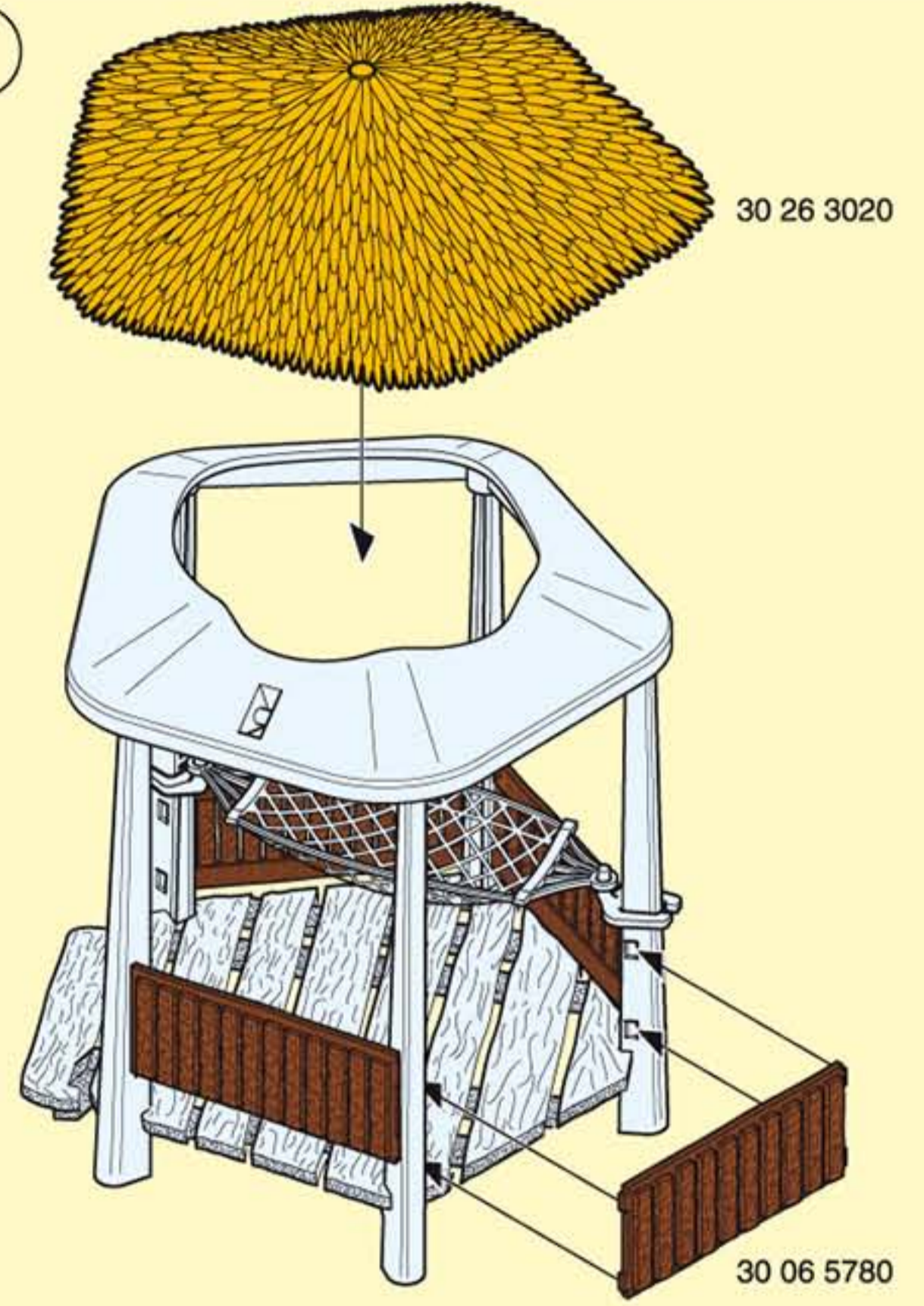

30 22 3510 30 08 9940
30 23 8420

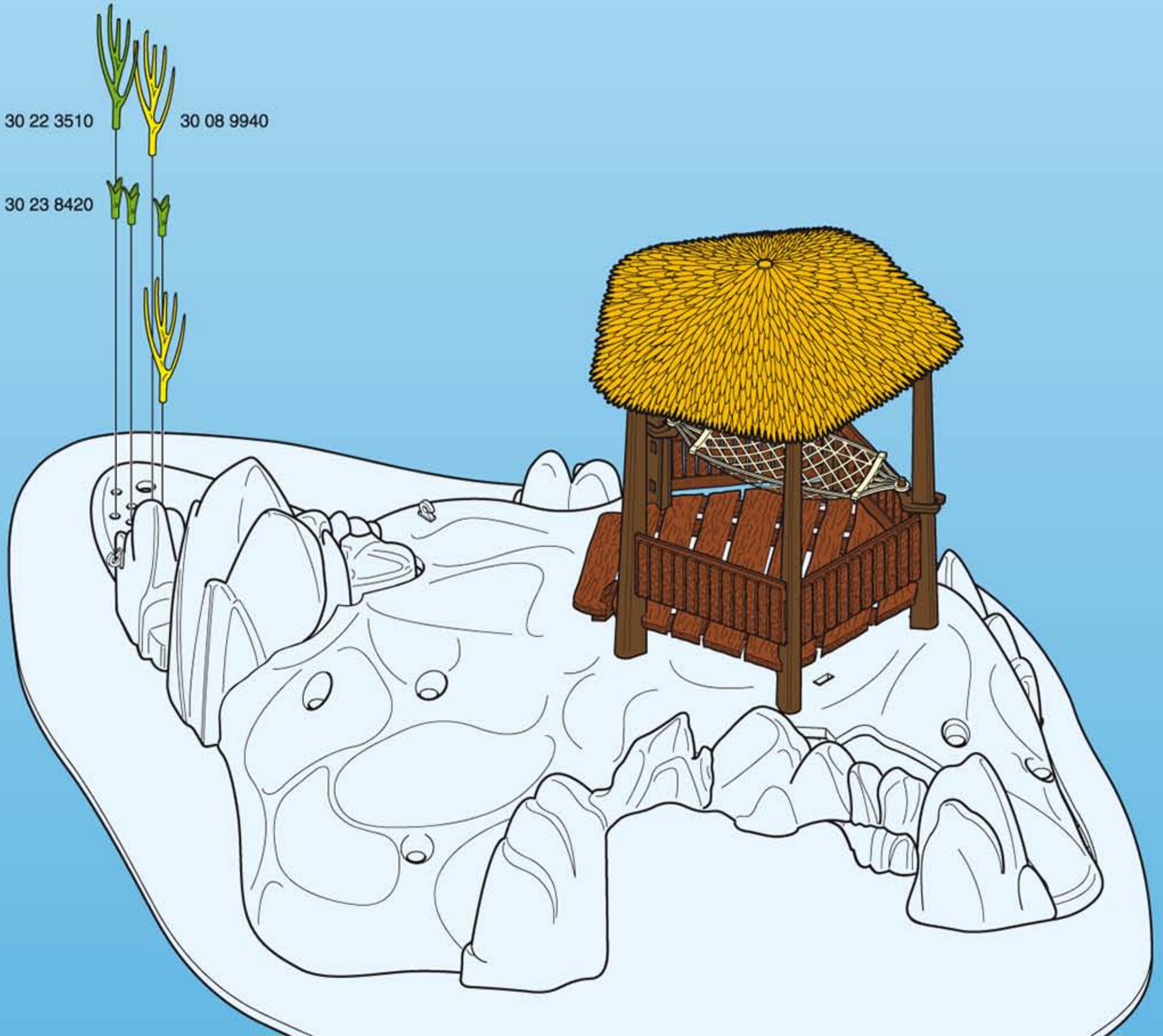

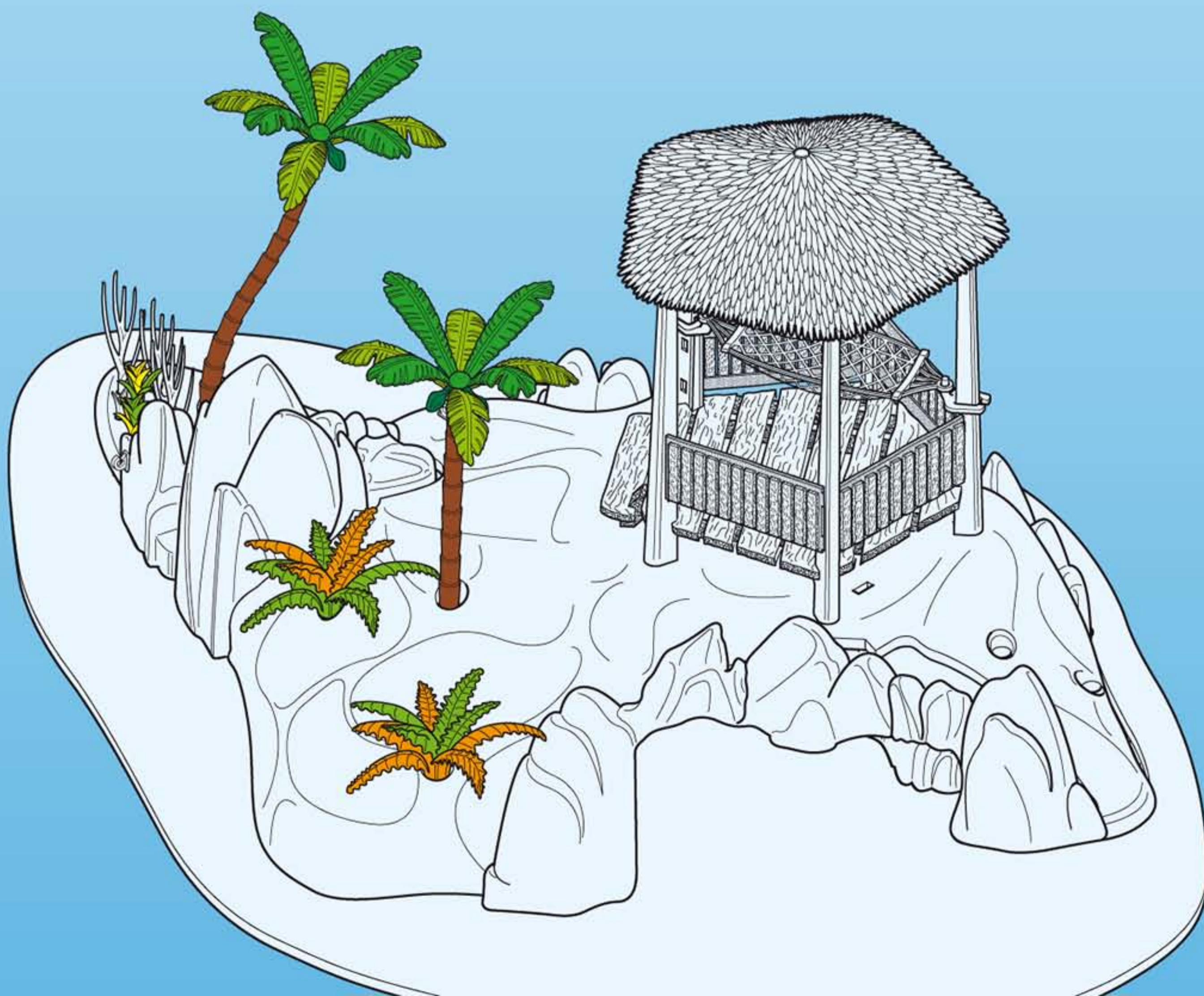
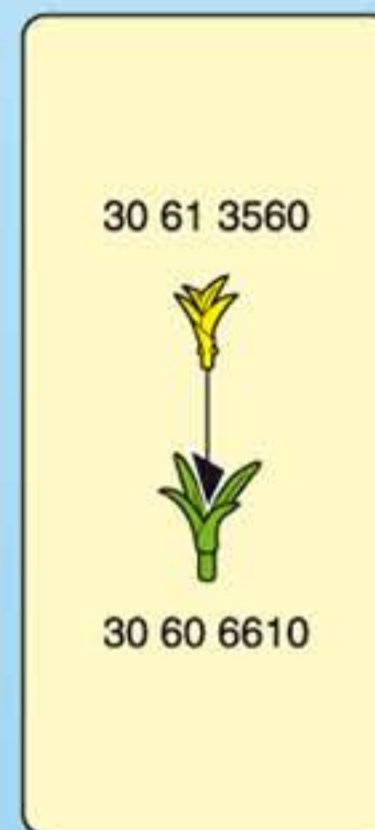
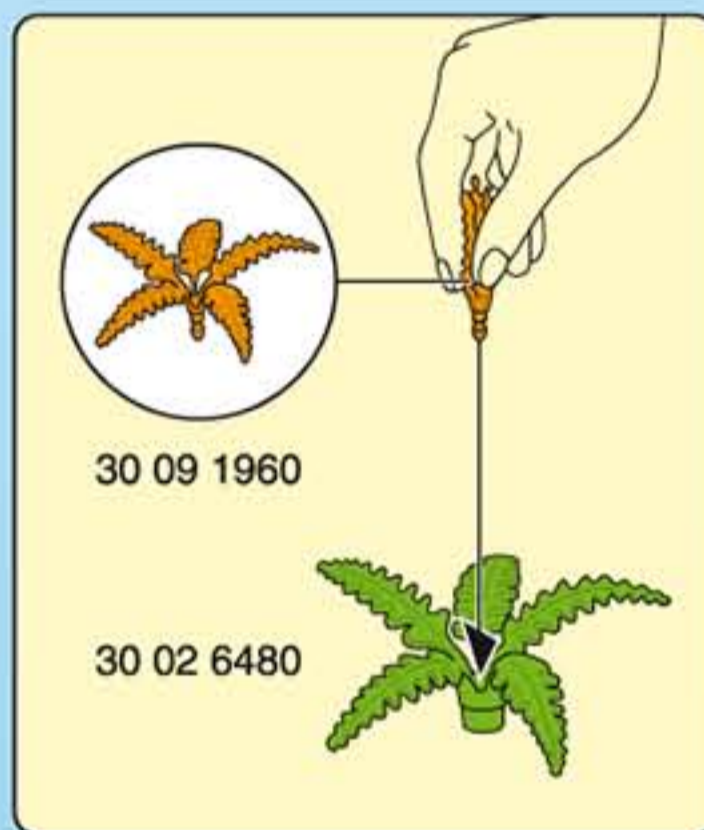
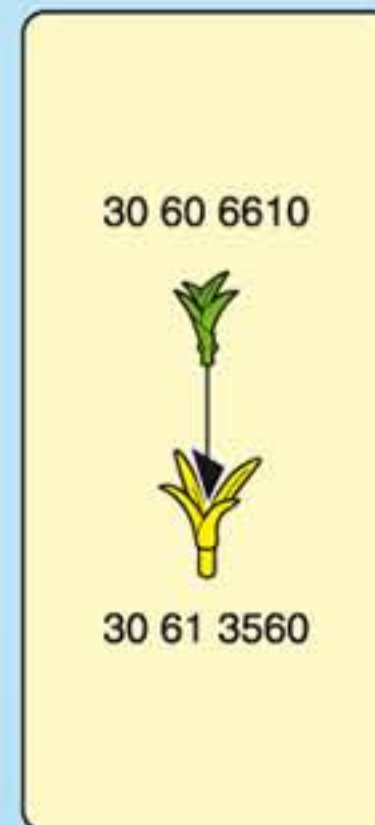
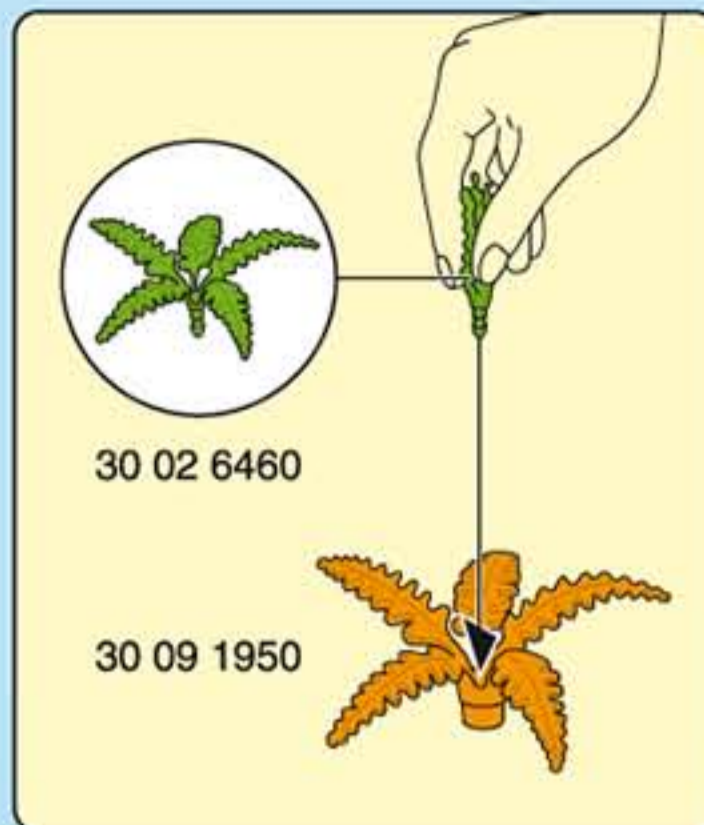
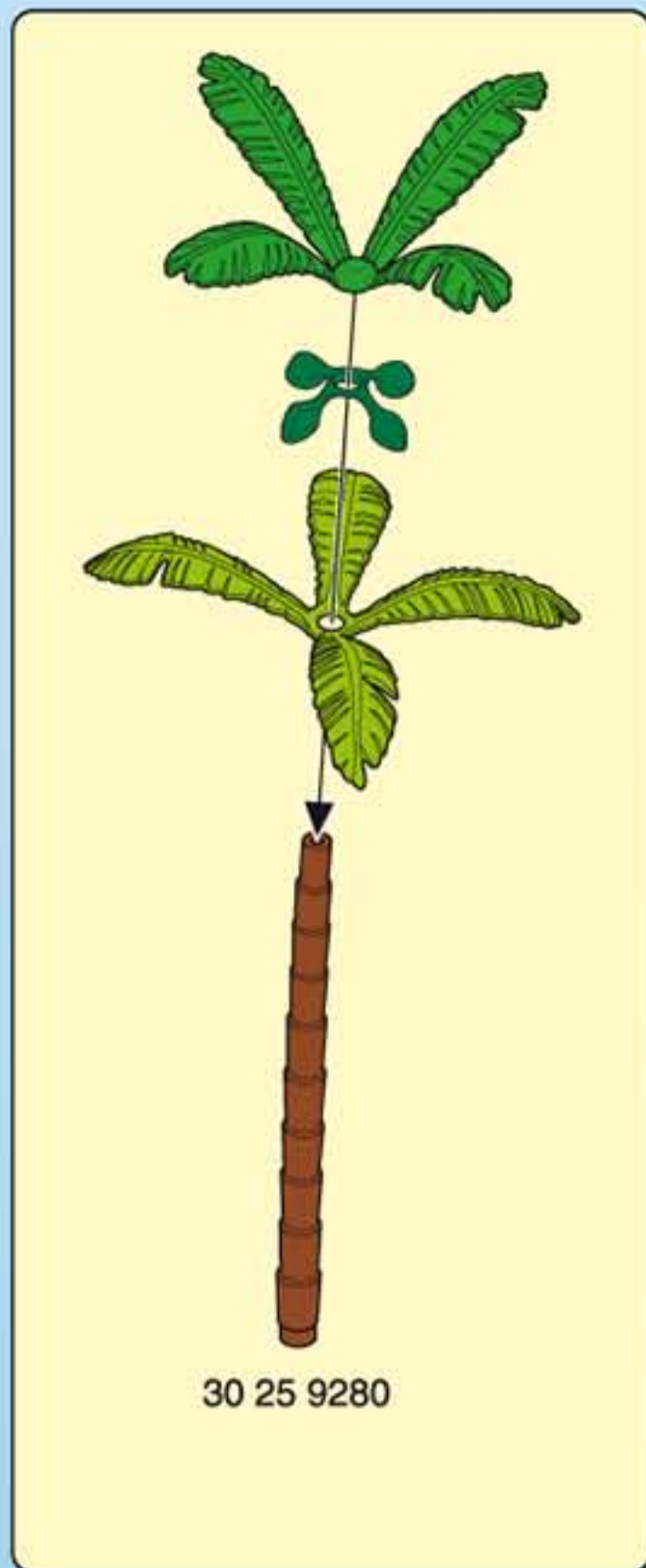
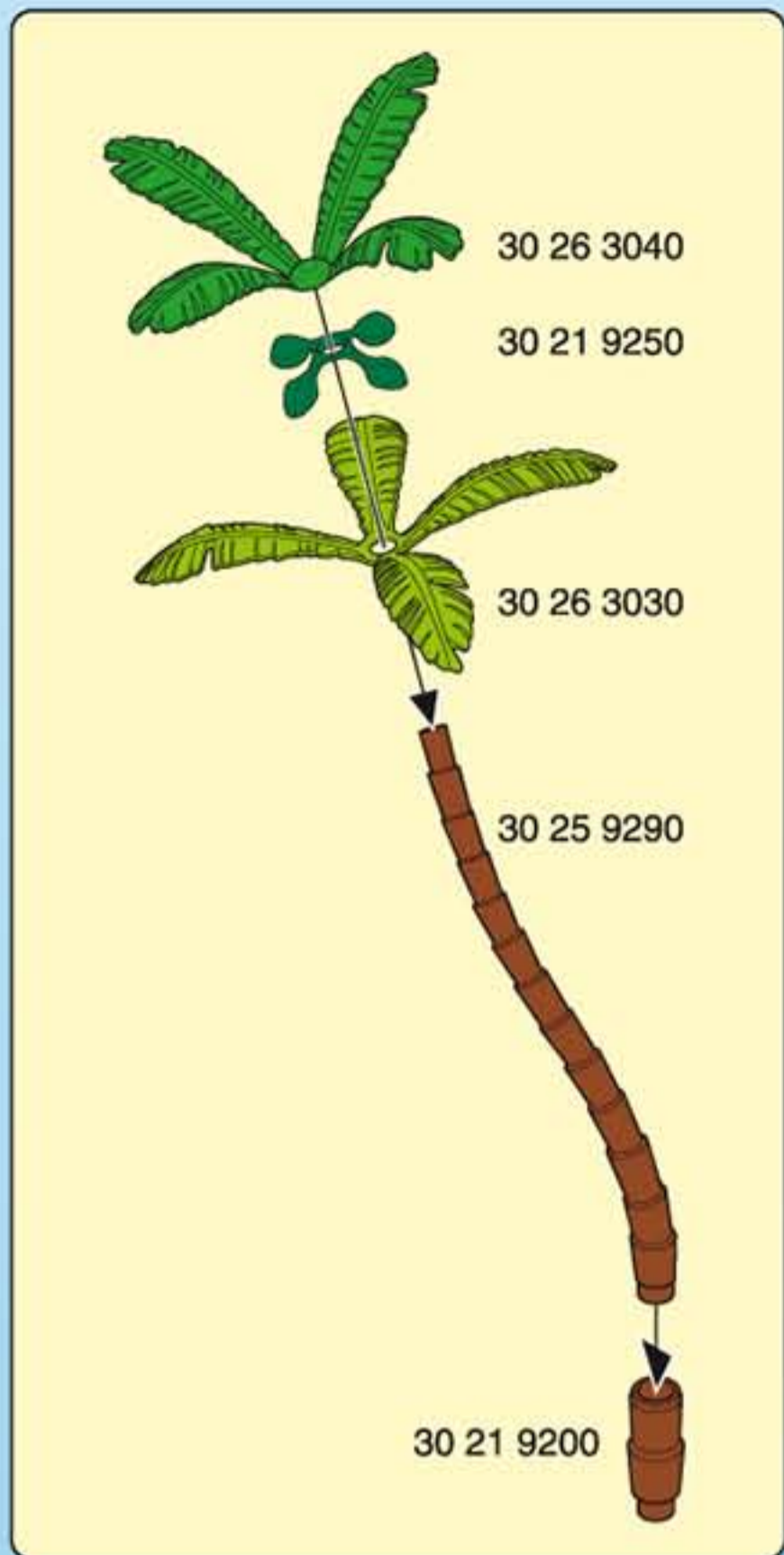

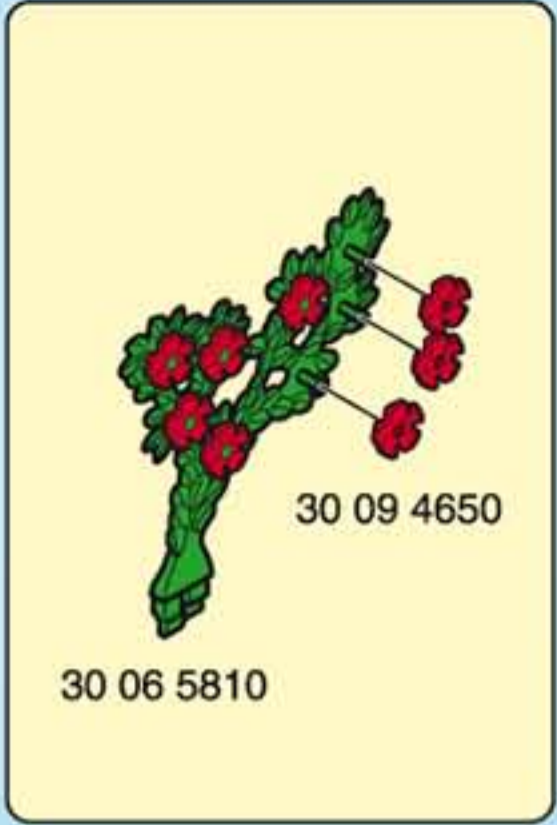
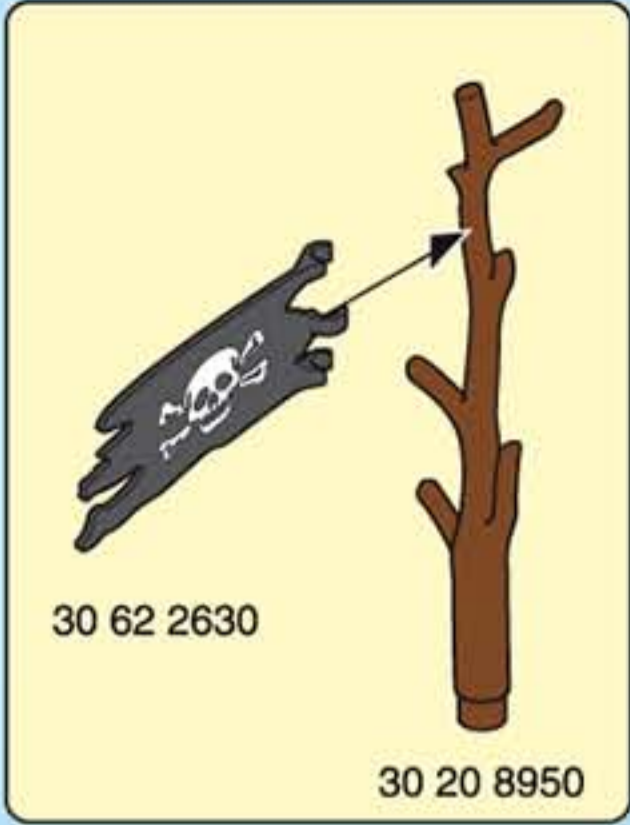
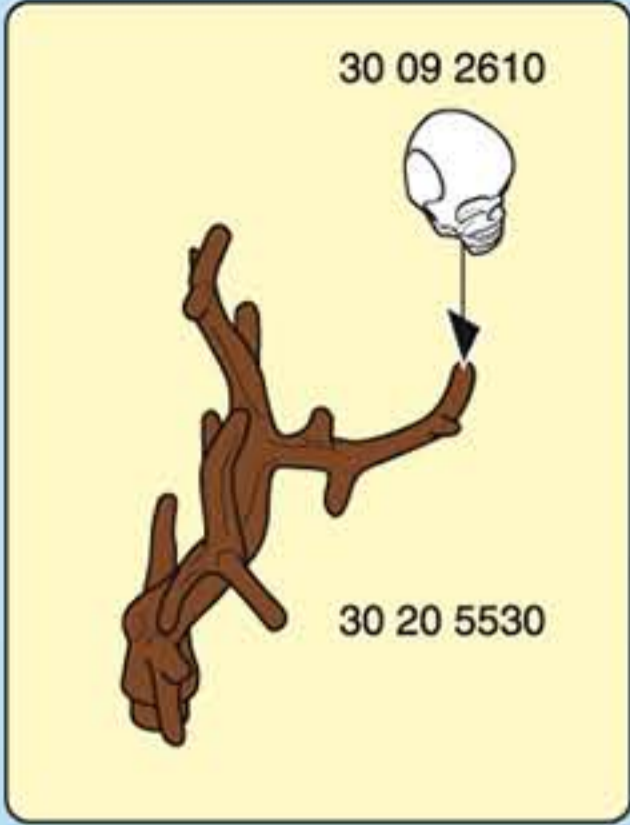

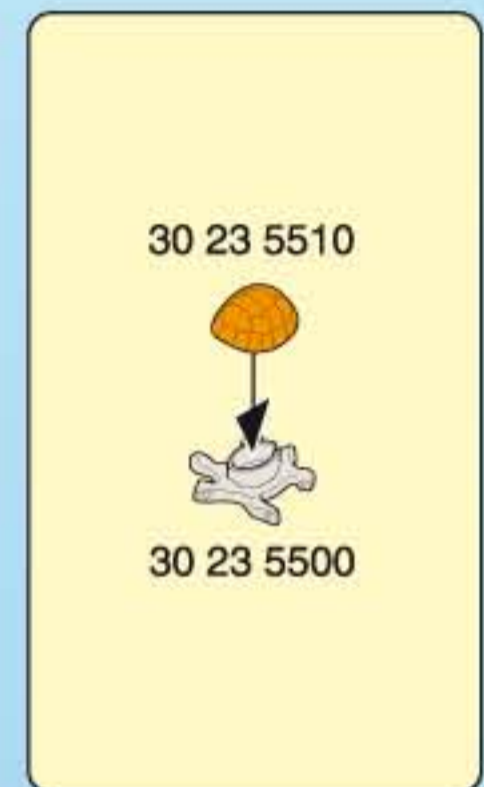
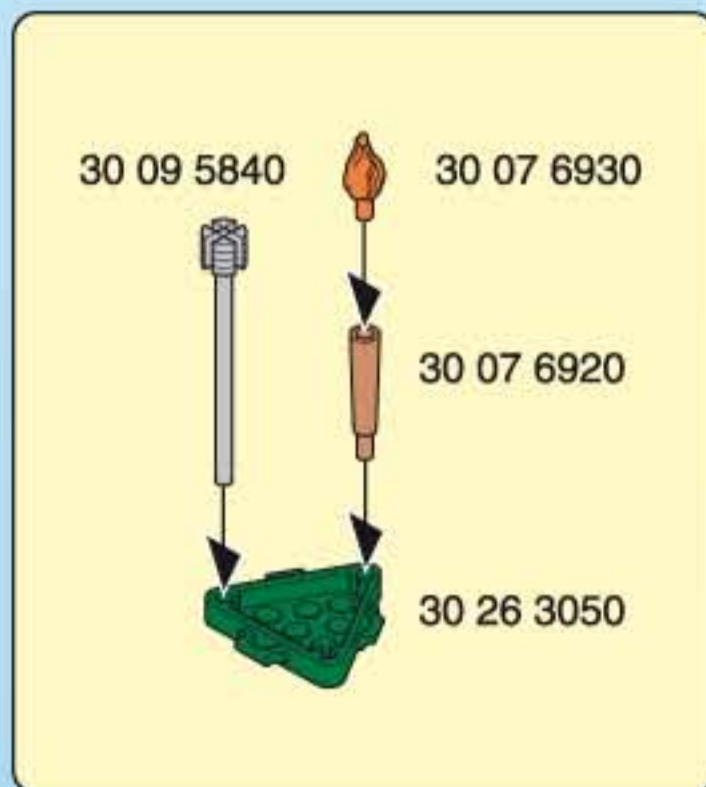
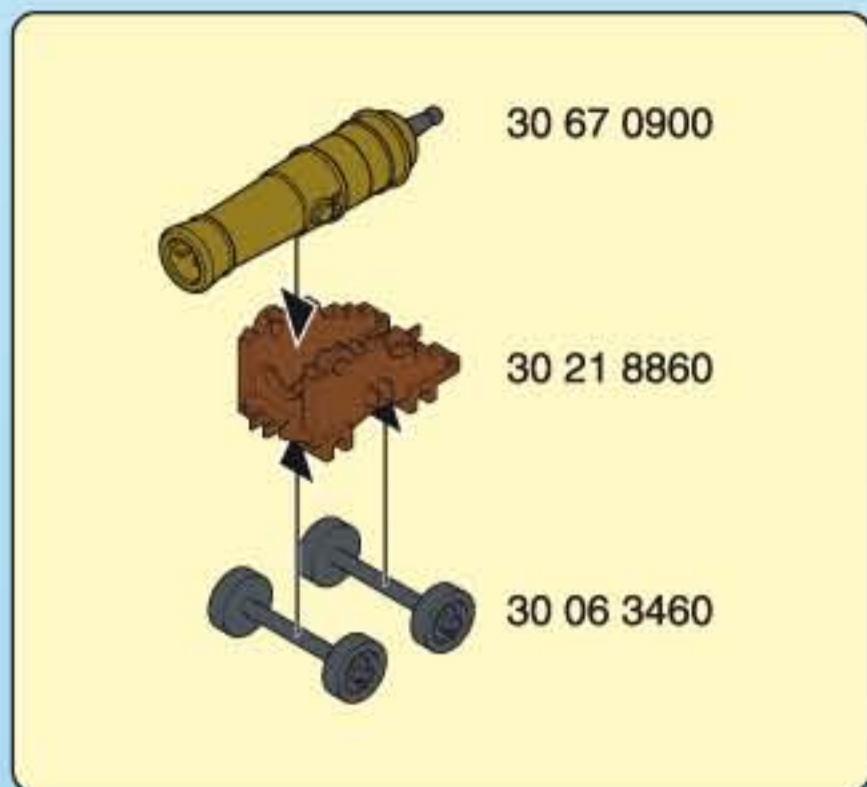
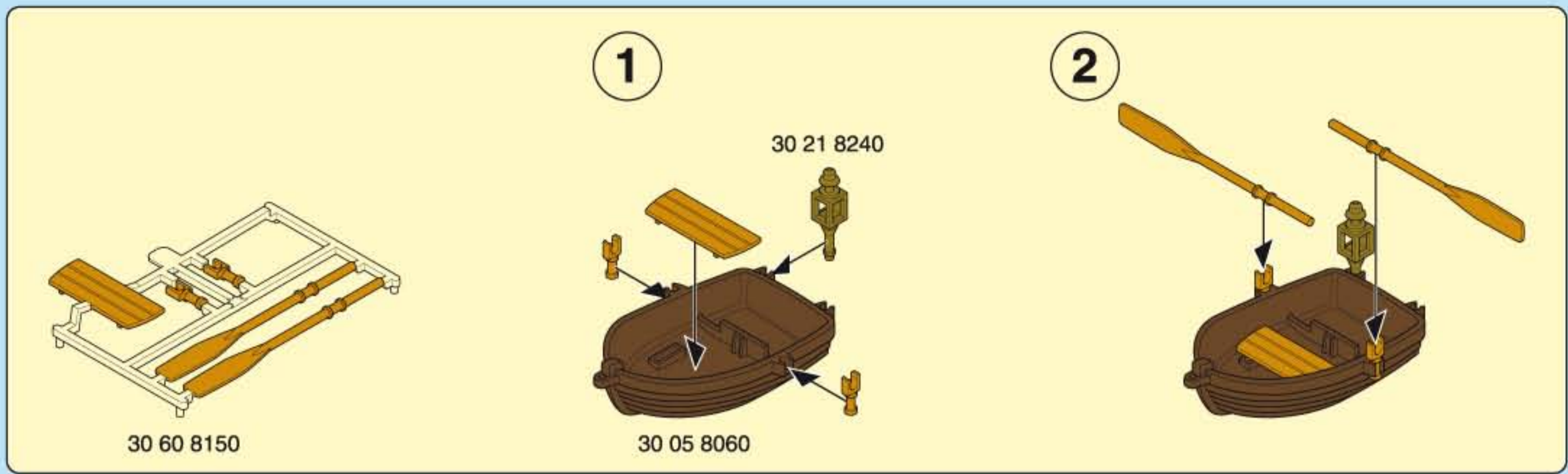

(D) (A) (CH) (L) WARNUNG!
 - Nur unter Aufsicht und nur in flachem Wasser benutzen.
 - NUR PLAYMOBIL - KANONENKUGELN VERWENDEN - NICHT AUS UNMITTLBARER NÄHE AUF JEMANDEN ZIELEN !

(USA) (GB) (CDN) (M) WARNING!
 - Only to be used in water in which the child is within depth and under supervision
 - ONLY USE PLAYMOBIL CANNON BALLS ! NEVER AIM THEM AT ANOTHER PERSON.

(F) (CDN) (B) (L) (CH) ATTENTION!
 - À n'utiliser qu'en eau où l'enfant a pied et sous surveillance.
 - ATTENTION ! NE PAS UTILISER D'AUTRES PROJECTILES QUE LES BOULETS DE CANON PLAYMOBIL - NE PAS TIRER À BOUT PORTANT.

(E) (MEX) ; ADVERTENCIA!
 - Se deberá utilizar solamente en el agua, donde el niño haga pie y bajo vigilancia.
 - UTILIZAR SOLAMENTE PROYECTILES DEL CAÑON PLAYMOBIL. NO APUNTAR NUNCA A LAS PERSONAS.

(NL) (B) WAARSCHUWING!
 - Alleen gebruiken onder toezicht, in water waarin het kind kan staan.
 - ALLEEN DE PLAYMOBIL - KOGELS GEBRUIKEN. NOOIT OP IEMAND RICHTEN !

(I) (CH) ATTENZIONE!
 - Utilizzare solo in acque dove il bambino tocca con i piedi e sotto sorveglianza.
 - USARE SOLO PROIETTILI DA CANNONE PLAYMOBIL. NON SPARARE NELLE DIRETTE VICINANZE DI PERSONE.

(P) AVISO!
 - Utilizar apenas em águas em que a criança tenha pé e sob vigilância.
 - UTILIZE SEMPRE BALAS DE CANHÃO PLAYMOBIL. NUNCA AS ATIRE CONTRA QUEM QUER QUE SEJA.

(DK) ADVARSEL!
 - Må kun anvendes under opsyn og på vanddybder, hvor barnet kan bunde.
 - ANVEND KUN PLAYMOBIL KANONKUGLER. SIGT ALDRIG PÅ NOGEN I UMIDDELBAR NÆRHED.

(N) ADVARSEL!
 - Skal kun brukes i vann som ikke er for dypt for barnet, og der barnet er under tilsyn.
 - BRUK KUN PLAYMOBIL KANONKULER - IKKE BRUK ANDRE LIGNENDE GJENSTANDER OG SIKT IKKE PÅ NOEN I NÆRHETEN.

(S) (FIN) VARNING!
 - Får endast användas på grunt vatten och under uppsikt av vuxen.
 - ANVÄND ENDAST PLAYMOBILS KANONKULOR. SIKTA INIE PÅ NÅGON MÄNNISKA.

(FIN) VAROITUS!
 - Käytetään ainoastaan matalassa vedessä, jossa lapsi voi seistä ja on aikuisen valvonnassa.
 - KÄYTÄ VAIN PLAYMOBIL TYKINLUOTEJA - ÄLÄ KOSKAAN AMMU IHMISIÄ KOHTI.

(GR) (CY) ΠΡΟΣΟΧΗ!
 - Να χρησιμοποιείται μόνο σε νερά όπου πατώνει το παιδί και κάτω από επίβλεψη.
 - Μπορείτε να χρησιμοποιείτε μόνον σφαιρίδια κανονιού Playmobil! Μην τα πετάτε σε ανθρώπους που βρίσκονται σε μικρή απόσταση.

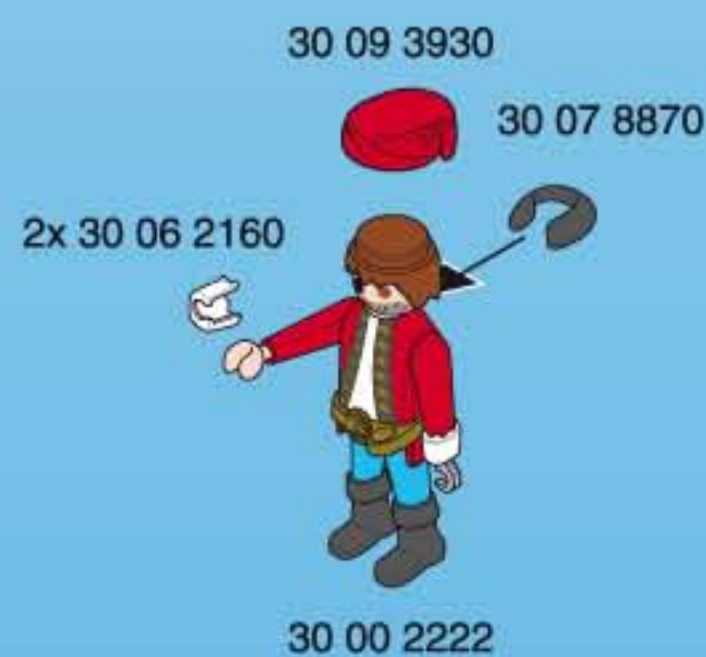

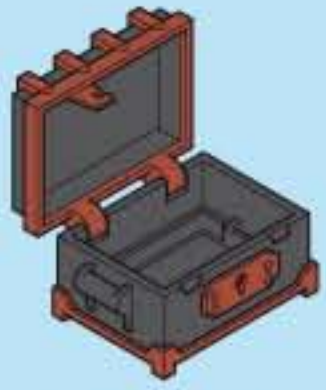

30 66 2370



30 02 2950

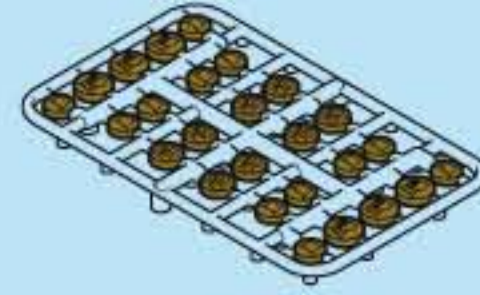

30 89 7572



30 88 0132



30 02 3780



30 21 5510



30 21 7720



30 09 5500



30 23 9810



2x 30 21 0920



30 21 0940



30 21 0950



30 22 8670



30 83 0350



30 02 6260



30 20 6100



30 09 5530



30 20 4490



30 51 0510

Serviceadressen finden Sie in allen Playmobil-Prospekten

Addresses of Customer Service Departments are shown in all Playmobil catalogues

L'adresse du service consommateurs est indiquée dans tous les catalogues Playmobil

Troverete gli indirizzi dei centri di assistenza in tutti i cataloghi Playmobil

Las Direcciones de los Departamentos de Servicio al Consumidor se encuentran en todos los catálogos Playmobil

Η διεύθυνση του Γραφείου Εξυπηρέτησης Πελατών είναι καταχωρημένη σε όλους τους καταλόγους Playmobil

pronounce: plāy-mō-bēəl