

playmobil®
4008



**WARNING:
CHOKING HAZARD**

Small parts. Not for children under 3 years.

"Ne concerne que les USA"

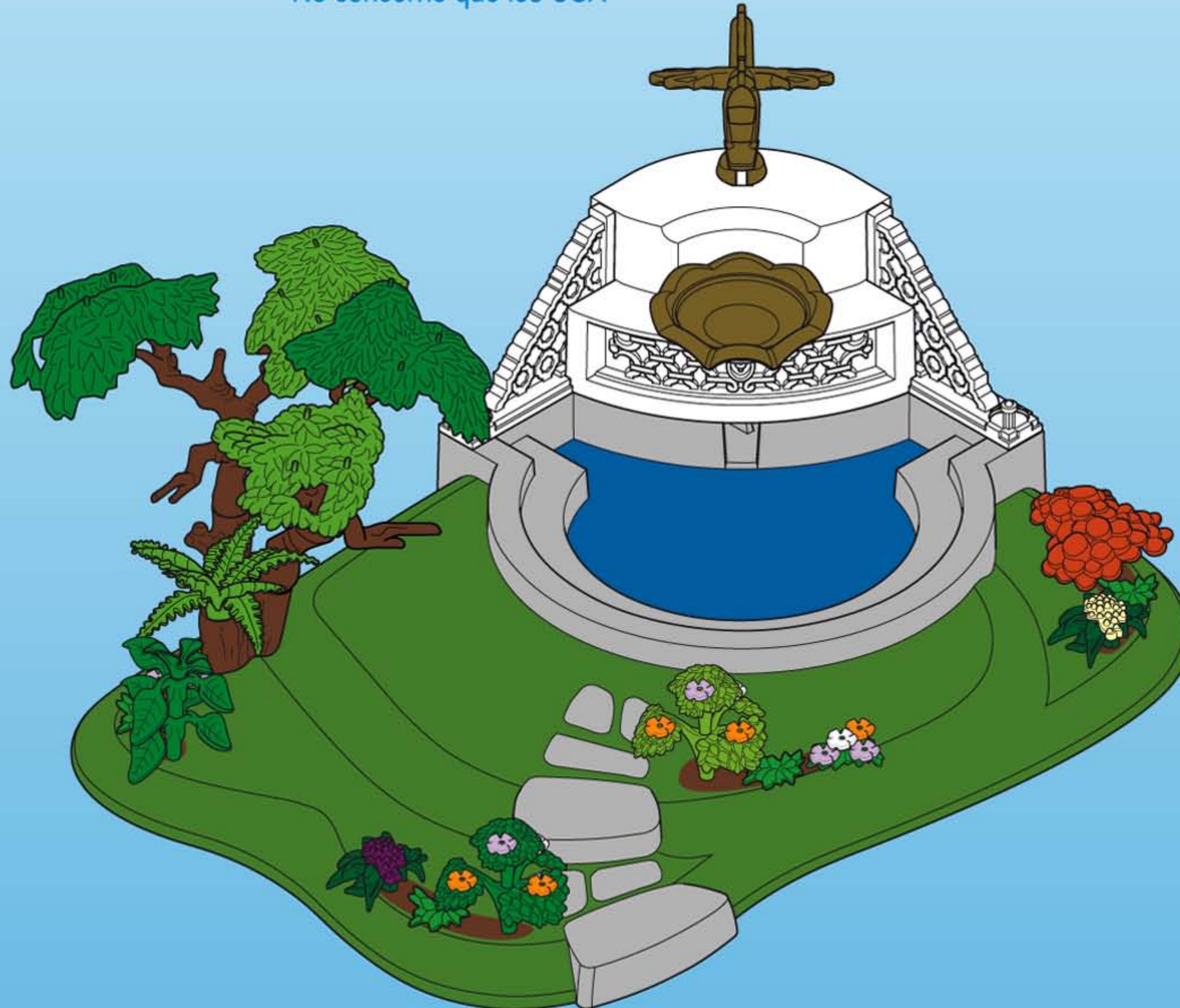

Wichtige Unterlagen, bitte sorgfältig aufbewahren!
Important documents keep carefully!
Documents importants conservez avec soin!
Belangrijke documenten, bewaar deze zorgvuldig!

Serviceadressen finden Sie in allen Playmobil-Prospekten

Addresses of Customer Service Departments are shown in all Playmobil catalogues

L'adresse du service consommateurs est indiquée dans tous les catalogues Playmobil

Troverete gli indirizzi dei centri di assistenza in tutti i cataloghi Playmobil

In alle PLAYMOBIL catalogi vindt u het adres van onze klantendienst.

Las Direcciones de los Departamentos de Servicio al Consumidor se encuentran en todos los catálogos Playmobil

Η διεύθυνση του Γραφείου Εξυπηρέτησης Πελατών είναι καταχωρημένη σε όλους τους καταλόγους Playmobil

pronounce: plāy-mō-bēēl

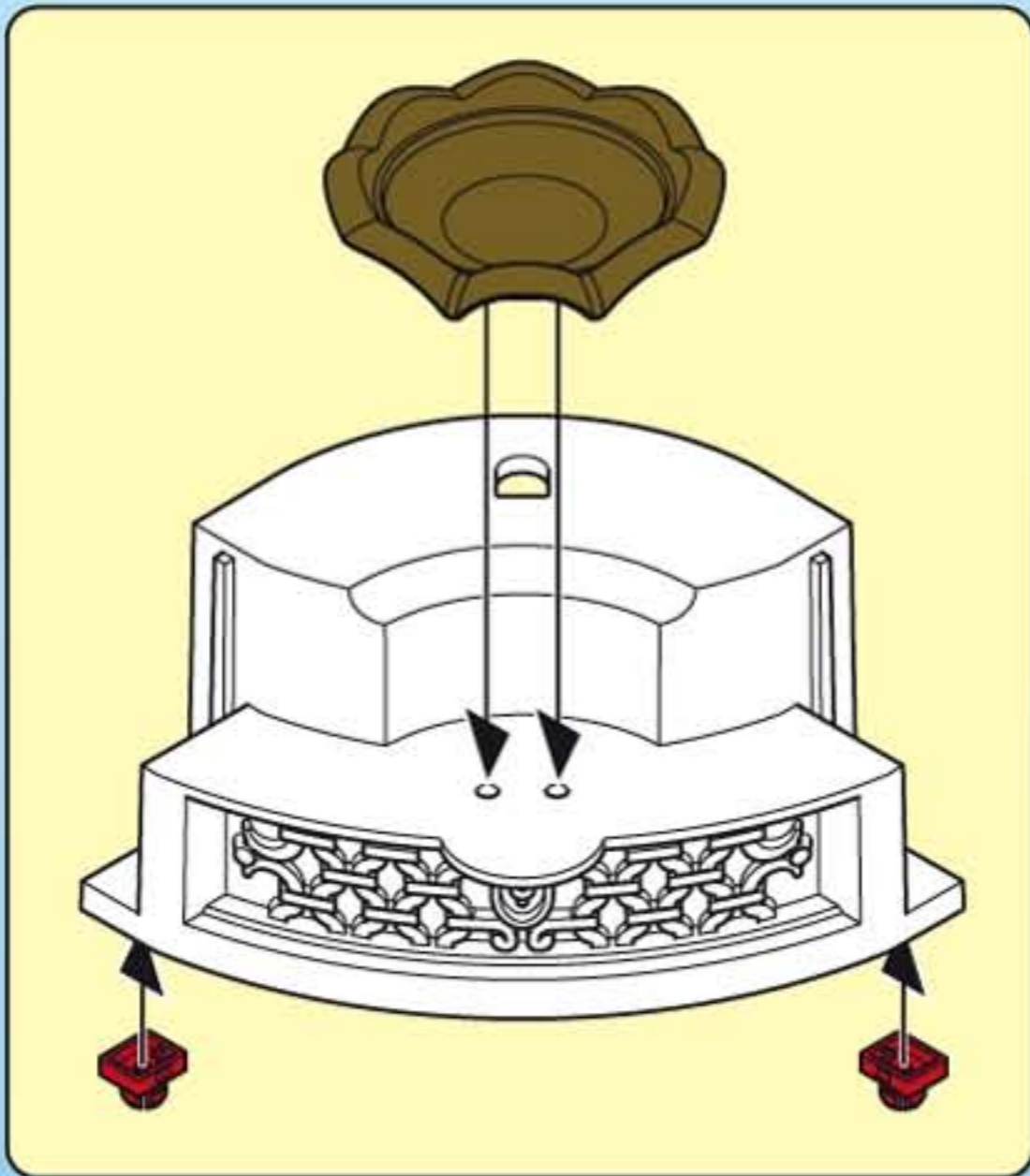
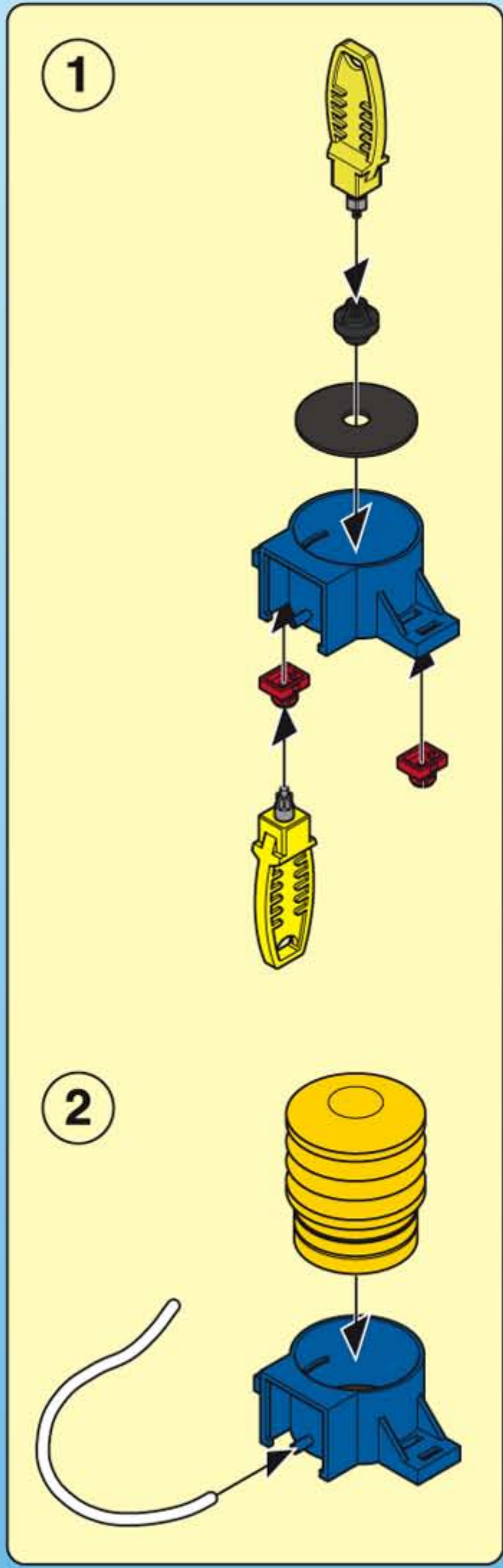

1

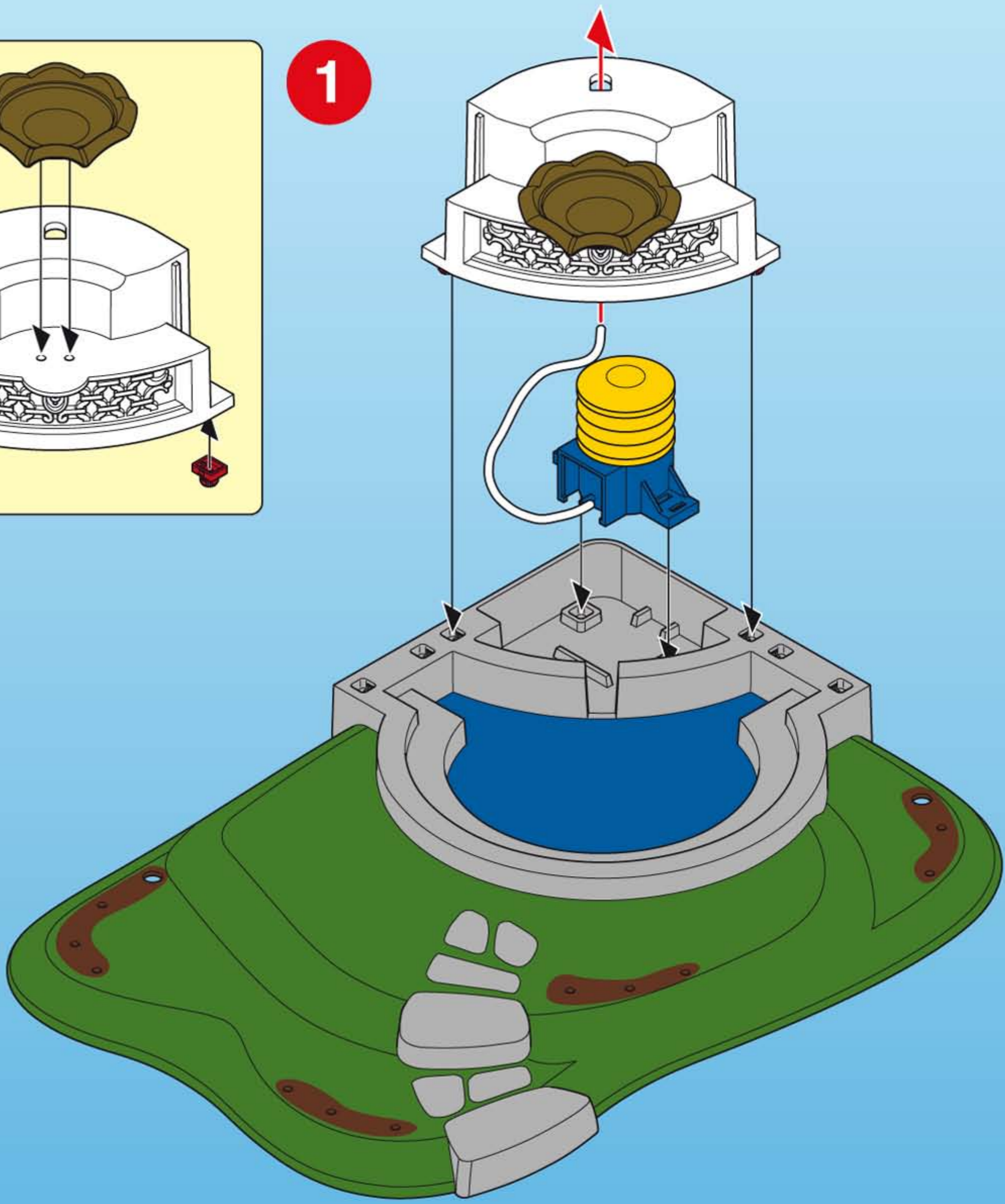

2

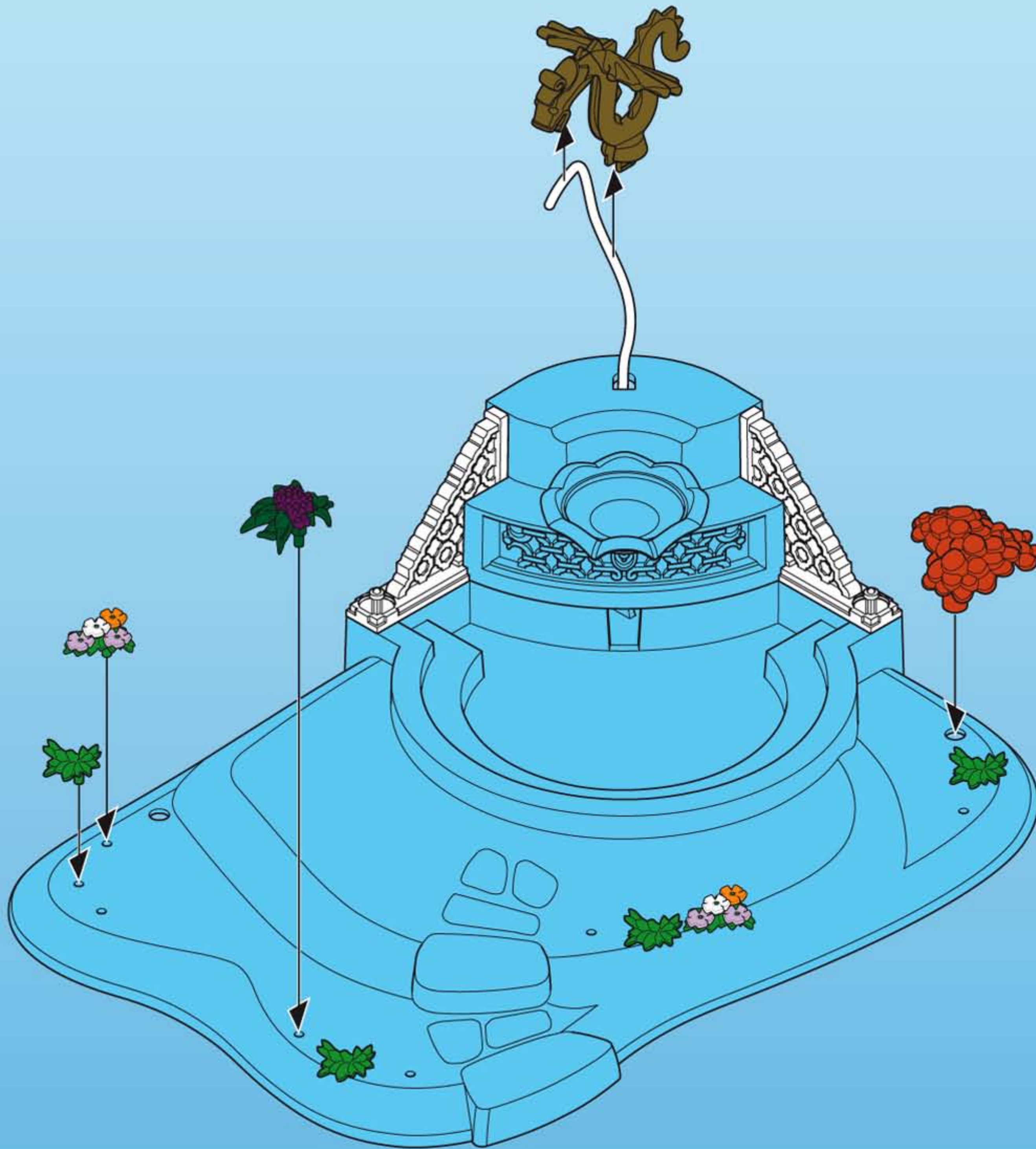
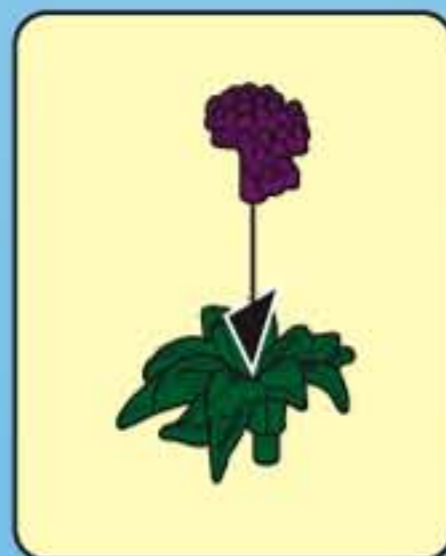
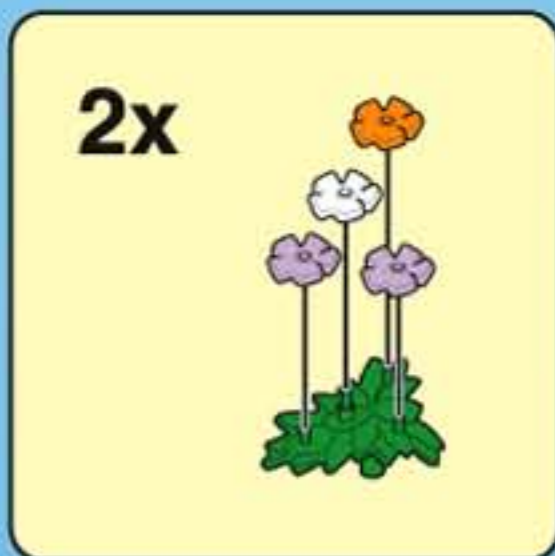
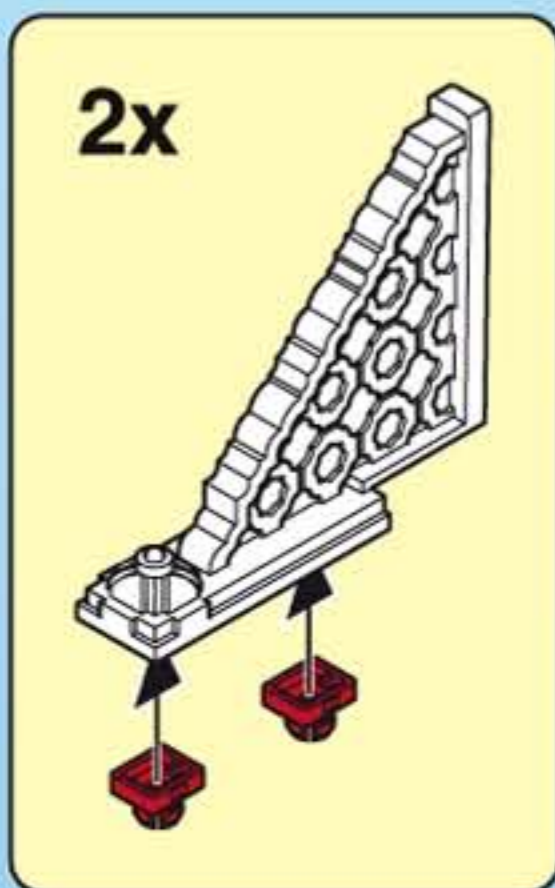

3

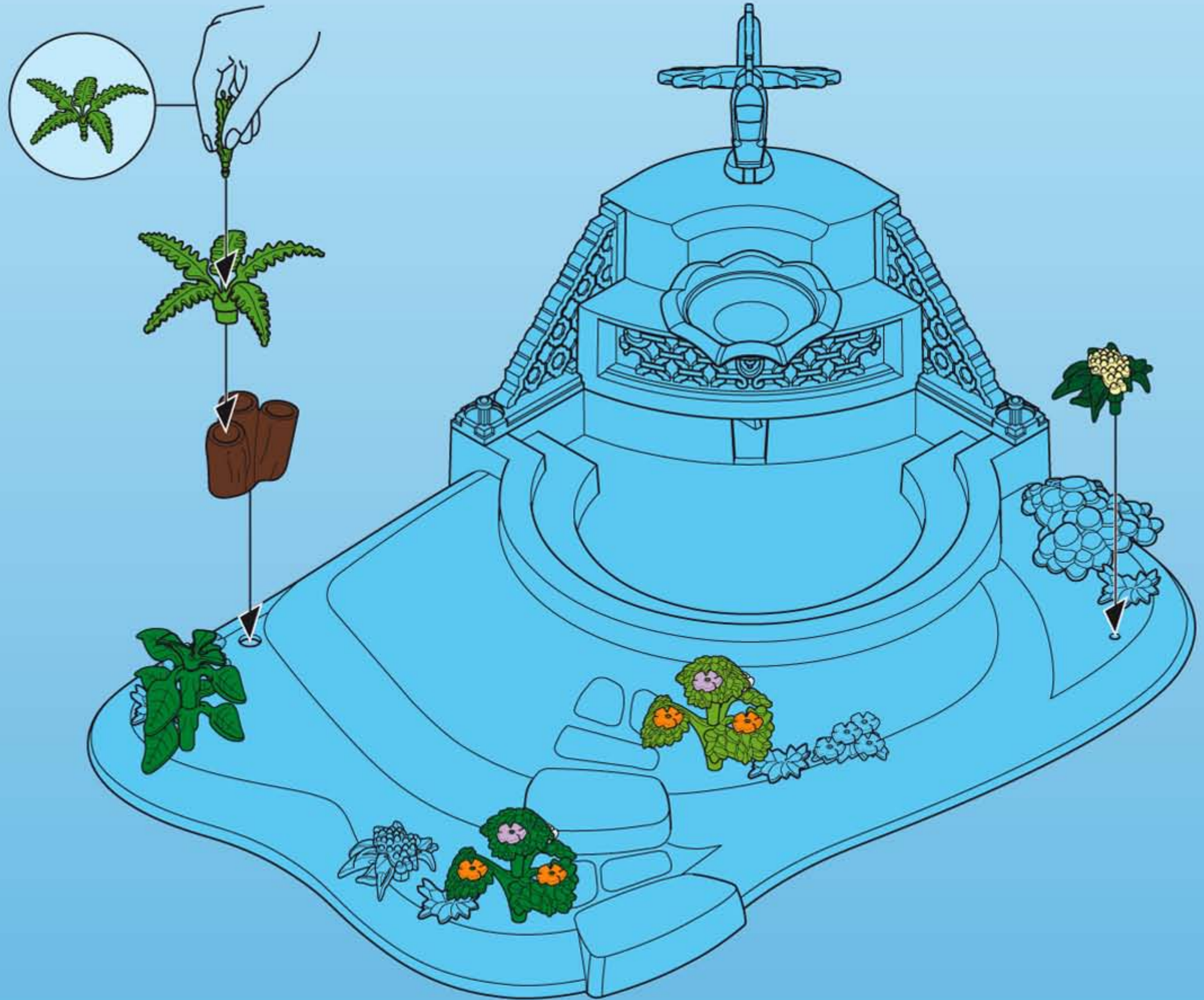
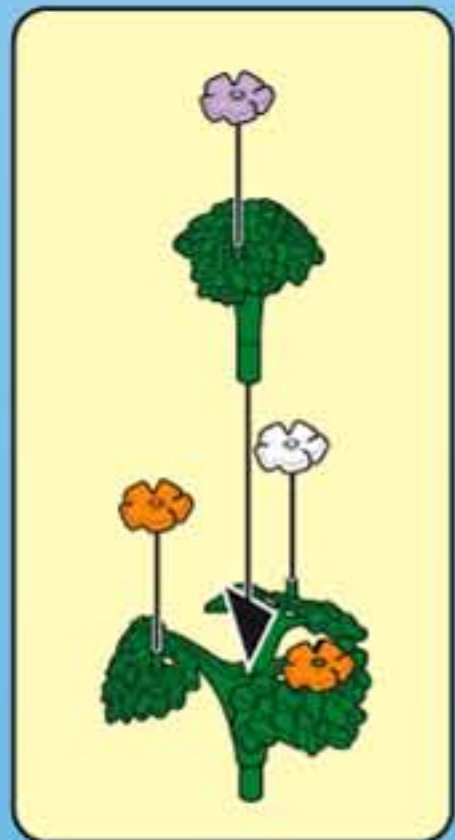
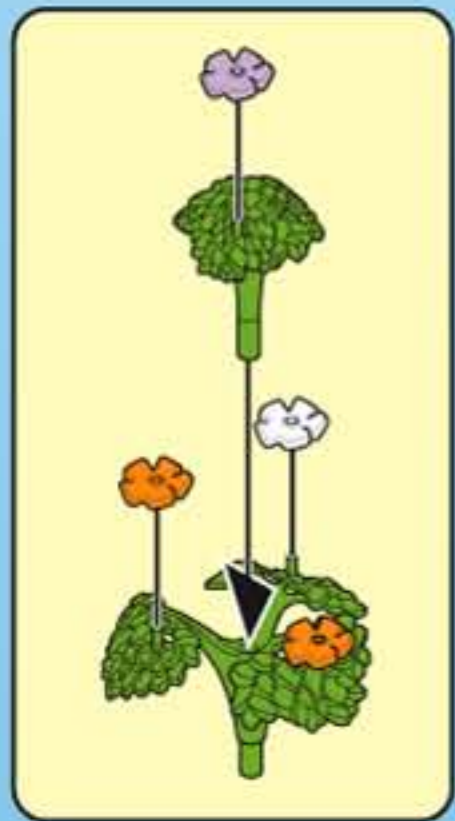
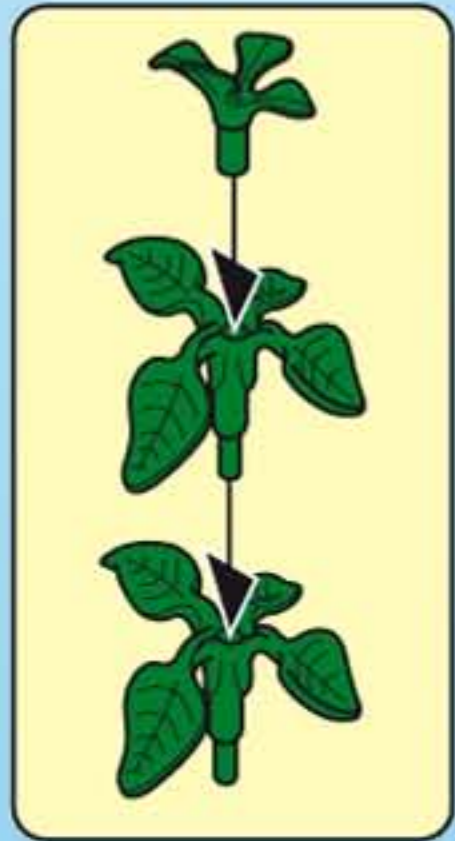

4

4

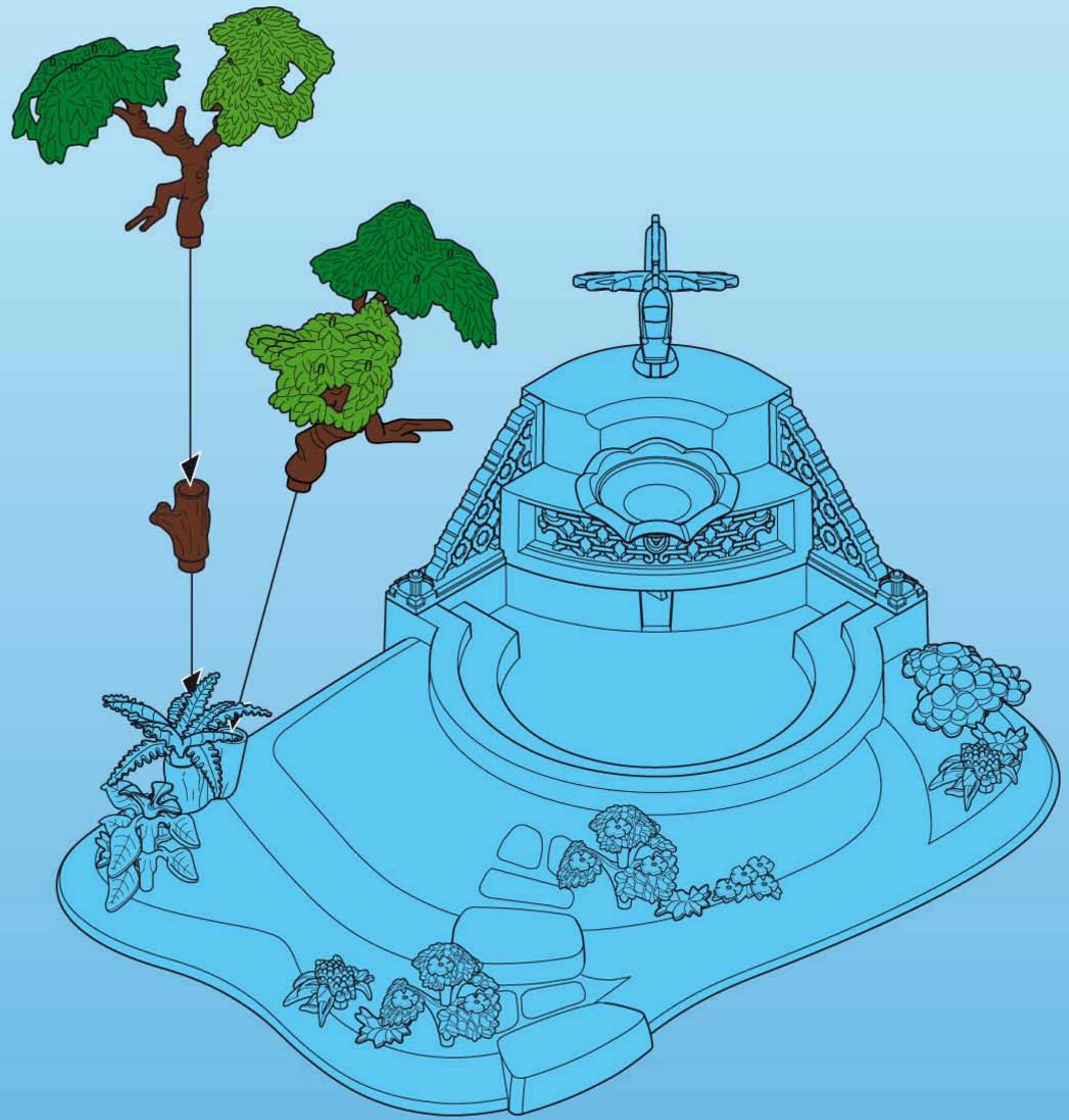
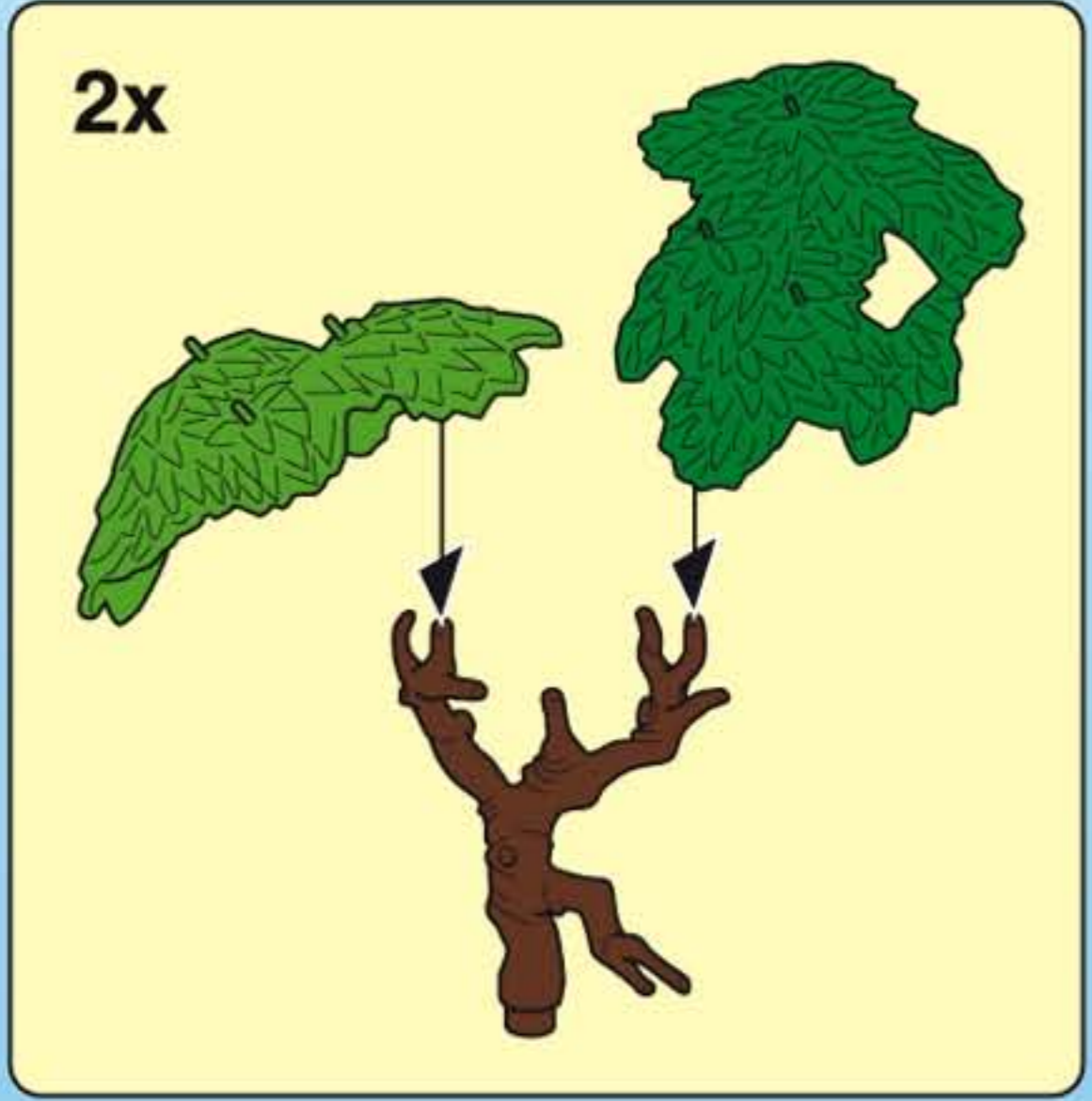

D A CH L B Nur Trinkwasser verwenden. Nach dem Spielen austrocknen lassen.

USA GB CDN M IRL Use only tap water. Dry thoroughly after play.

F CDN B L CH N'utiliser que de l'eau potable. Faire sécher après chaque utilisation.

E MEX Utilizar solamente agua potable. Dejar secar antes de guardar.

NL B Enkel drinkbaar water gebruiken. Na het spelen laten drogen.

I CH Usare solo acqua potabile. Asciugare bene dopo ogni uso.

P Utilizar somente água potável. Deixar secar antes de guardar.

DK Anvend kun drikkevand. Lad det tørre ud når du er færdig med at lege.

N Kun drikkevann skal benyttes. Tørk opp etter at leken er ferdig.

S FIN Använd endast dricksvatten. Låt torka efter användandet.

FIN Käytä ainoastaan juomavettä. Anna kuivua leikin jälkeen.

H Kérjük kizárólag ivóvizet használgjon! Játék után ajánlott a termék kiszáritása!

CZ Používat jen pitnou vodu. Po hraní nechat vyschnout.

EST Kasutada üksnes joogivett! Mängimise järel kuivatada!

LV Izmantot tikai dzeramo ūdeni. Pēc spēlēšanās ļaut nožūt.

LT Naudokite tik geriamąjį vandenį. Pažaidus, išdžiovinkite.

SLO V igračo vlivajte le pitno vodo. Po igri naj se igrača posuši.

SK Používať iba pitnú vodu. Po hre nechať vyschnúť.

PL Używaj tylko wodę pitną. Po zabawie pozostaw do wyschnięcia.

TR CY Sadece içme suyu kullanınız. Oyundan sonra kurumaya bırakın.

GR CY Χρησιμοποιείστε μόνο νερό βρύσης. Μόλις τελειώσετε, αφήστε το παιχνίδι να στεγνώσει εντελώς.

RO Se folosește doar apă potabilă. După joacă se lasă să se usuce.

BG Използвайте само питейна вода. След игра оставете да изсъхне.

CN 仅使用饮用水。玩耍后要干燥。

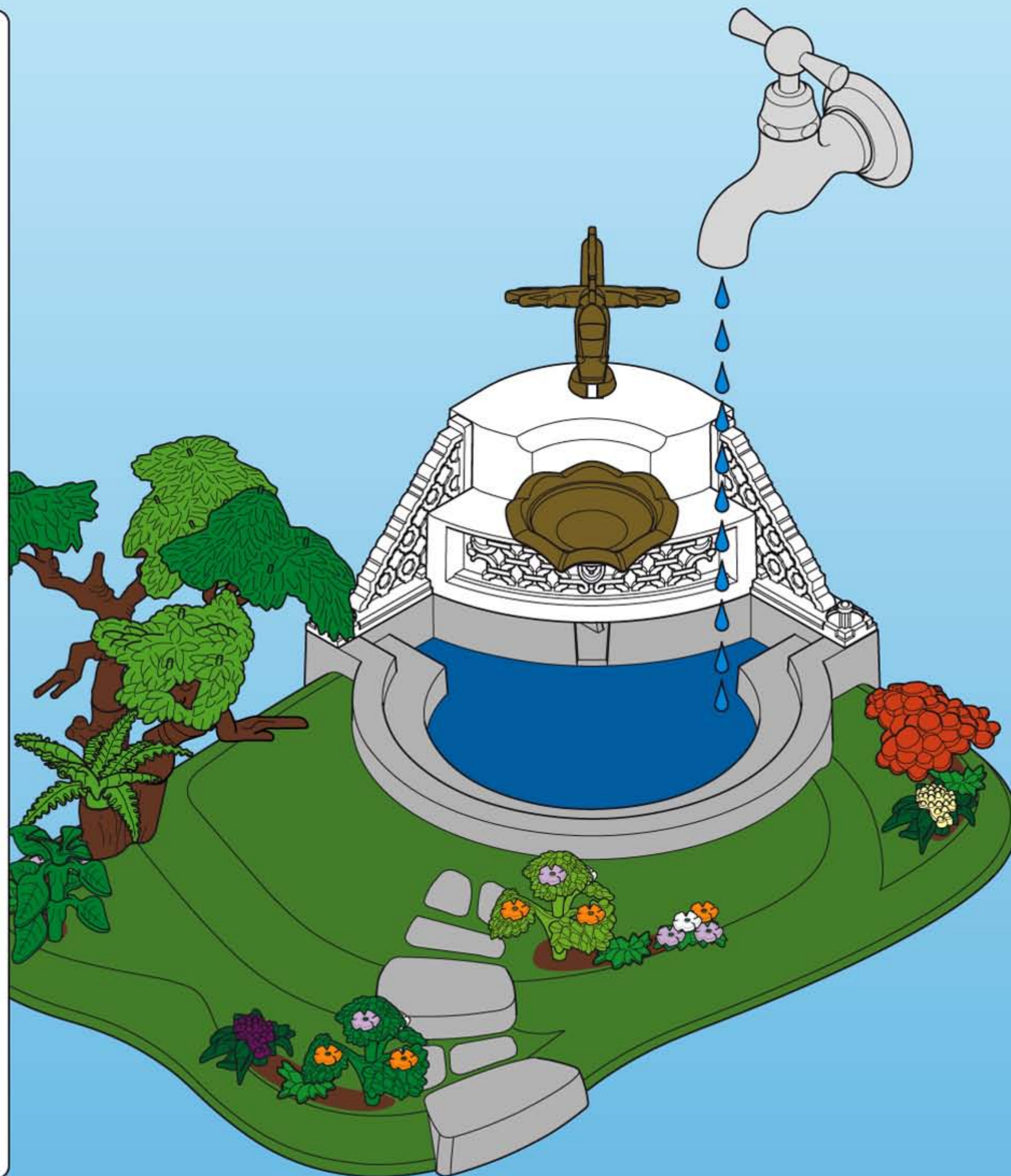

2x

30 20 4450
30 02 6840
30 02 6830

30 28 7530
30 28 7520

30 22 3562
30 22 3572

30 22 3542
30 22 3532

30 20 6072
30 14 4920

2x 30 27 7870
30 28 0370
30 11 1620

30 63 4792

30 02 6270
30 65 5832

30 27 4070

30 51 4420

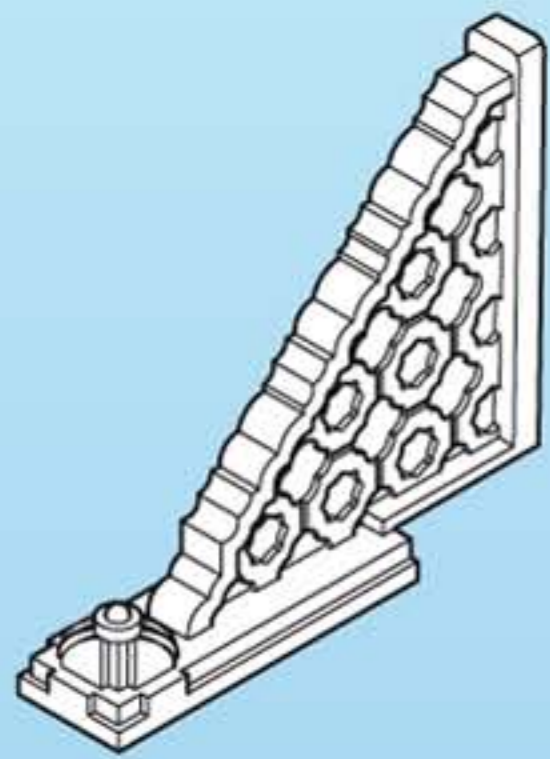

2x 30 27 4080



2x 30 20 7580



2x 30 02 3900



2x 30 02 4260



30 89 0962



30 65 8822



30 23 5030



30 23 8600



30 02 6480



30 02 6460



2x 30 22 0300

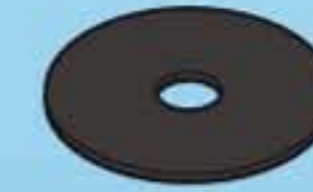

30 89 0982



30 23 7050



30 22 5780



30 23 4950



2x 30 26 0600



30 64 4172



30 22 5790



30 23 4960



30 20 8370



30 66 5950



30 20 5030



2x 30 03 2920



30 89 8940



4x 30 04 2760



30 25 7330



30 02 4130



30 02 4200



3x 30 83 1130



30 26 0380



30 26 0570



30 28 1950



30 02 6640



8x 30 09 6900



6x 30 05 9729

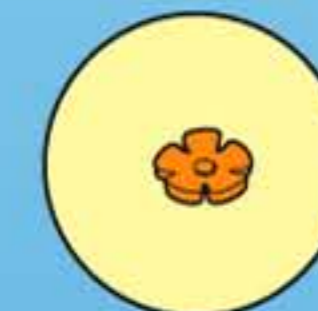

8x 30 24 9820



6x 30 25 3100