

playmobil®

3950

WARNING:
CHOKING HAZARD - SMALL PARTS
Not for children under 3 years.

"Ne concerne que les USA"

Wichtige Unterlagen, bitte sorgfältig aufbewahren !
Important documents keep carefully !
Documents importants conservez avec soin !



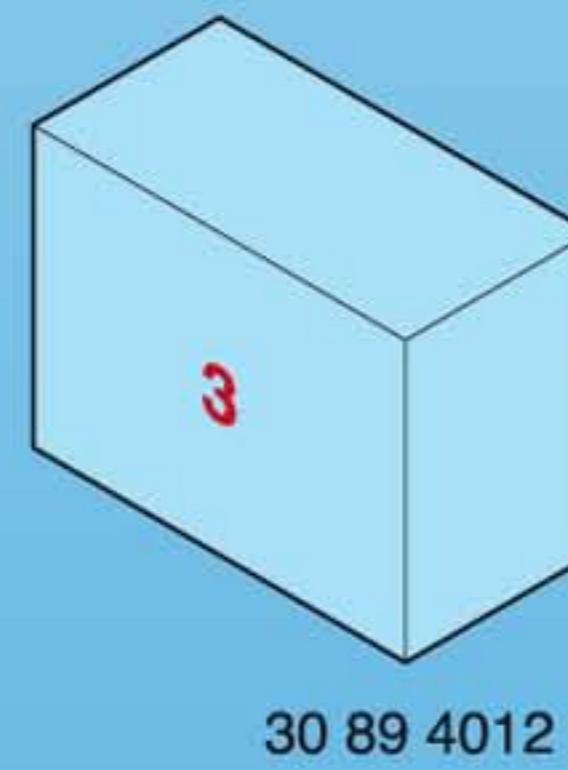
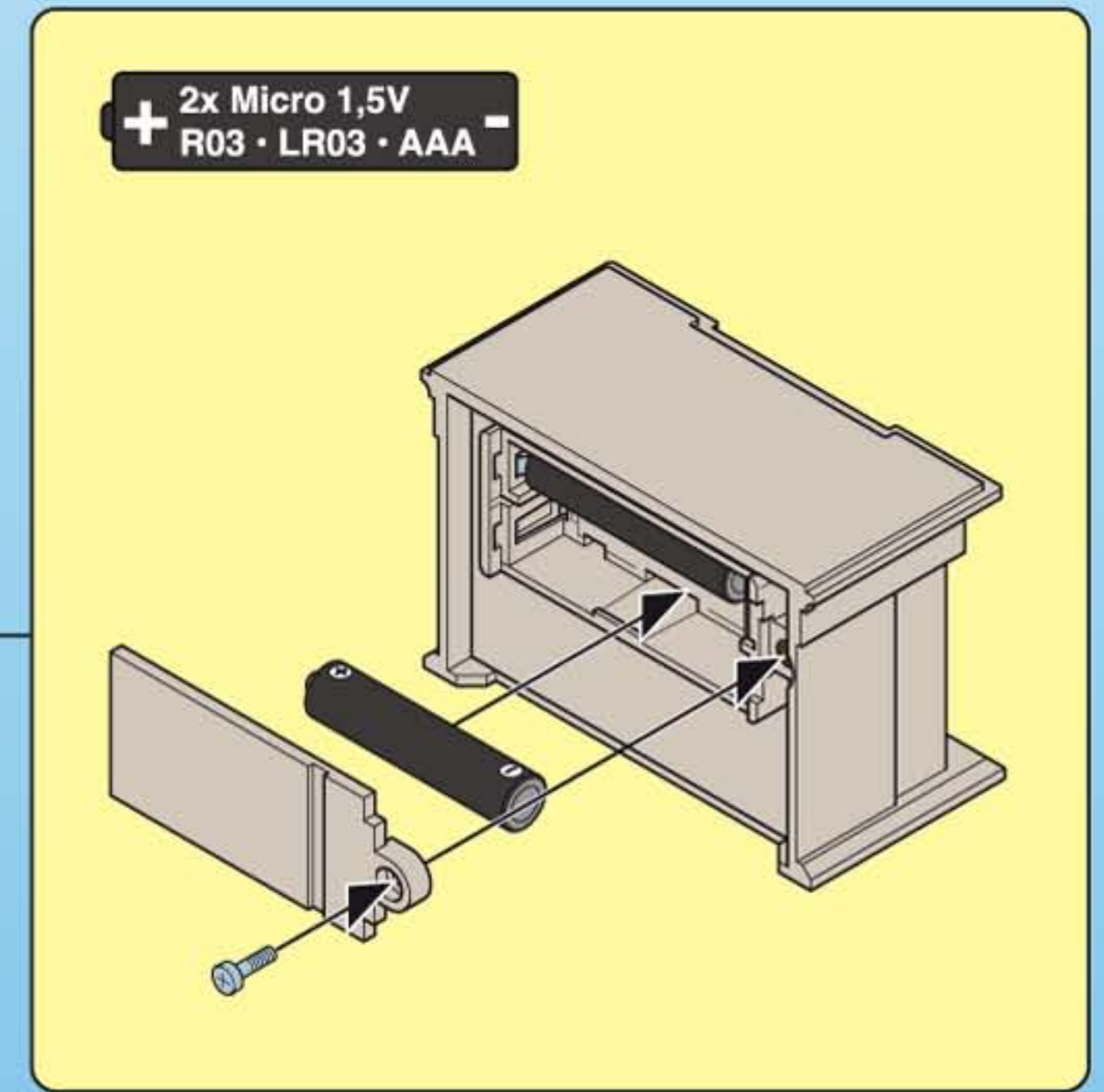
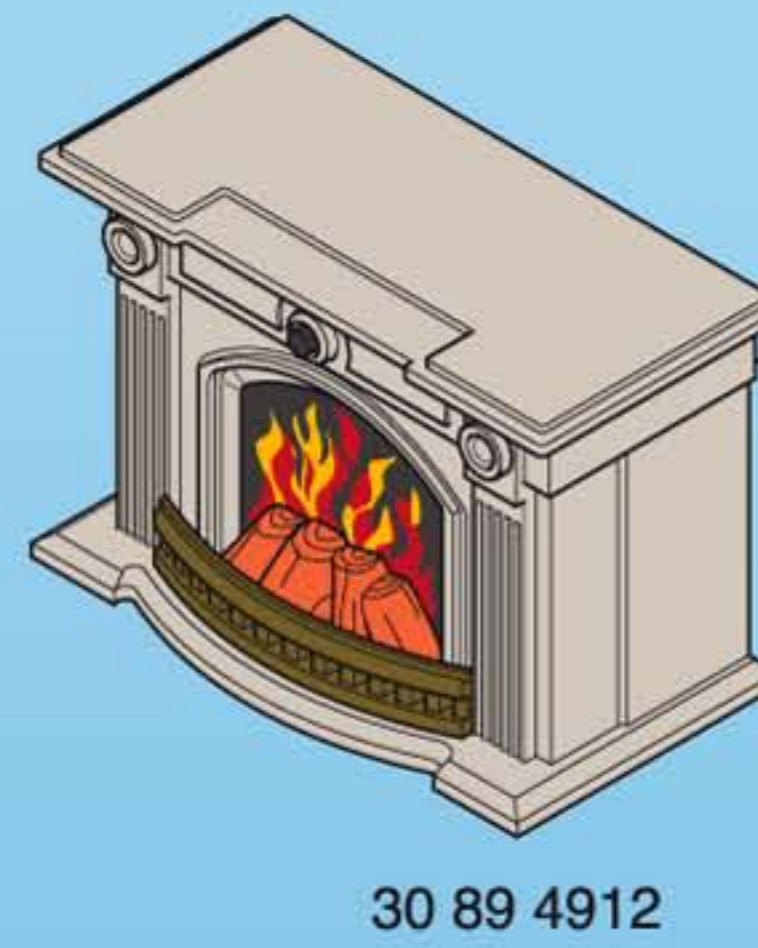
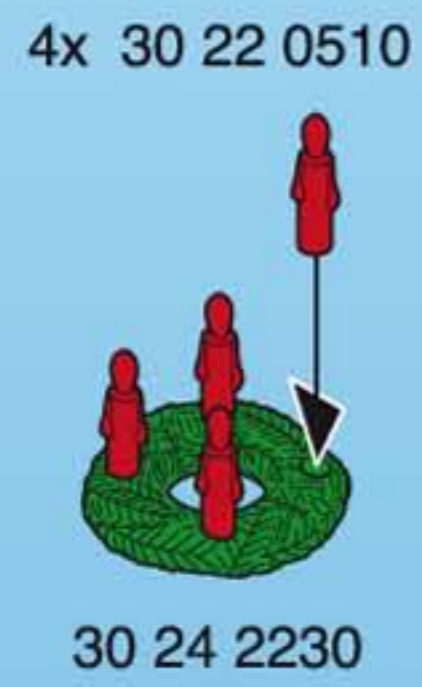

(D) (A) (CH) DIESES SPIELZEUG DARF NUR MIT BATTERIETYPEN R03/LR03/AAA BETRIEBEN WERDEN! BATTERIEN REGELMÄSSIG AUF AUSLAUFEN ÜBERPRÜFEN! ERSCHÖPFTE BATTERIEN AUS DEM SPIELZEUG HERAUSNEHMEN! NICHTAUFLADBARE BATTERIEN DÜRFEN NICHT AUFGELADEN WERDEN! AUFLADBARE BATTERIEN VOR DEM LADEN AUS DEM SPIELZEUG ENTNEHMEN! AUFLADBARE BATTERIEN NUR UNTER AUFSICHT ERWACHSENER LADEN! BATTERIEN MIT DER RICHTIGEN POLARITÄT EINLEGEN! UNGLEICHE BATTERIETYPEN ODER NEUE UND GEBRAUCHTE BATTERIEN DÜRFEN NICHT ZUSAMMEN VERWENDET WERDEN! VERBRAUCHTE BATTERIEN NICHT IN DEN HAUSMÜLL WERFEN, SONDERN NUR BEI DEN BESTEHENDEN SAMMELSTELLEN ODER EINEM SONDERMÜLLPLATZ ABGEBEN.

(USA) (GB) (CDN) THIS TOY MAY ONLY BE OPERATED WITH R03/LR03/AAA BATTERIES! BATTERIES SHOULD BE REGULARLY CHECKED FOR LEAKAGE! EXHAUSTED BATTERIES SHOULD BE REMOVED FROM THE TOY! NON-RECHARGEABLE BATTERIES MAY NOT BE RECHARGED! RECHARGEABLE BATTERIES MUST BE TAKEN OUT OF THE TOY BEFORE RECHARGING! RECHARGEABLE BATTERIES SHOULD BE RECHARGED UNDER ADULT SUPERVISION ONLY! BATTERIES SHOULD BE INSERTED WITH CORRECT POLARITY! BATTERIES OF DISSIMILAR TYPE OR NEW AND USED BATTERIES MAY NOT BE USED TOGETHER! USED BATTERIES SHOULD NOT BE DISPOSED OF IN HOUSEHOLD WASTE. PLEASE DISPOSE OF THEM AT A COLLECTION POINT OR SPECIAL WASTE SITE.

(F) (CDN) (B) Ce jouet ne doit être utilisé qu'avec le type de pile R03/LR03/AAA. Vérifier régulièrement si les piles coulent. Quand les piles sont usées, les enlever du jouet. Il n'est pas permis de recharger des piles qui ne sont pas rechargeables. Avant de recharger les piles qui peuvent l'être, les extraire du jouet. Ne recharger les piles que sous la surveillance d'adultes. Mettre les piles en place en veillant à la bonne polarité. Il ne faut pas utiliser ensemble des types différents de piles ni des piles neuves et des piles déjà utilisées. Ne pas jeter les piles usées dans la poubelle des ordures ménagères, mais aller les porter à la décharge spéciale ou à un centre de collecte, s'il y en a un.

(E) (MEX) Este juguete solamente debe ser utilizado con una pila del tipo R03/LR03/AAA. Comprobar periódicamente las pilas por si se saliesen. Sacar las pilas gastadas fuera del juguete. Las pilas no recargables no deben ser recargadas de nuevo. Las pilas recargables deben extraerse del juguete antes de cargarlas. Las pilas recargables deben ser cargadas solamente bajo la tutela de mayores. Colocar las pilas con los polos orientados en la posición correcta. No deben utilizarse juntos tipos de pilas desiguales o pilas nuevas y pilas gastadas. Las pilas gastadas no deben tirarse a la basura, sino entregarse exclusivamente en los puntos de recolección existentes o en vertederos de residuos especiales.

(NL) Dit speelgoed mag allen gebruikt worden met batterijen van het type R03/LR03/AAA! Batterijen regelmatig op lekkage controleren! Zwakke batterijen uit het speelgoed verwijderen! Niet oplaadbare batterijen mogen niet worden opgeladen! Oplaadbare batterijen voor het laden uit het speelgoed nemen! Oplaadbare batterijen alleen onder toezicht van volwassenen laden! Batterijen met de juiste poolrichting inzetten! Ongelijke batterijtypes en gebruikte batterijen mogen niet samen worden gebruikt! Lege batterijen niet bij het huisvuil doen maar bij de bestaande verzamelplaatsen voor speciaal afval afgeven.



Batterij niet weggooien, maar inleveren als KCA.

(I) QUESTO GIOCATTOLO PUO' ESSERE AZIONATO SOLO CON PILE DEL TIPO R03/LR03/AAA! CONTROLLARE REGOLARMENTE SE ESISTONO FUORIUSCITE DI LIQUIDO DALLE PILE! RIMUOVERE DAL GIOCATTOLO LE PILE ESAURITE! PILE NON RICARICABILI NON POSSONO ESSERE RICARICATE! PRIMA DI RICARICARLE, TOGLIERE LE PILE RICARICABILI DAL GIOCATTOLO! RICARICARE LE PILE RICARICABILI SOLO SOTTO LA SORVEGLIANZA DI PERSONE ADULTE! INSERIRE LE PILE CON LA CORRETTA POLARITA'! TIPI DI PILE DIFFERENTI OPPURE PILE NUOVE ED USATE NON POSSONO ESSERE UTILIZZATE INSIEME! NON GETTARE LE PILE SCARICHE NEI RIFIUTI DOMESTICI, MA DEPOSITARLE SOLAMENTE NEI LUOGHI DI RACCOLTA ESISTENTI OPPURE IN UN POSTO PER LO SMALTIMENTO DIFFERENZIATO.

(P) Pode-se usar este aparelho somente empregando pilhas do tipo R03/LR03/AAA. Examinar sempre se as pilhas estão bem carregadas. Retirar as pilhas gastas do brinquedo. Pilhas que não podem ser carregadas não devem ser carregadas. As pilhas que podem ser carregadas devem ser retiradas do brinquedo antes de serem carregadas. Carregar as pilhas carregáveis somente na presença de adultos. Colocar as pilhas com a polaridade correta. Tipos destinados de pilhas ou pilhas novas ou usadas nunca deverão ser usadas juntas. Nunca deitar pilhas usadas no lixo doméstico, mas sim deitá-las nos lugares de depósito previstos para tal ou num lugar de lixo especial.

(N) DENNE LEKEN SKAL KUN BRUKES MED BATTERIER AV TYPEN R03/LR03/AAA! KONTROLLER MED JEVNE MELLOMROM AT BATTERIENE IKKE LEKKER! TA TOMME BATTERIER UT AV LEKEN! IKKE OPPLADBARE BATTERIER MÅ ALDRI OPPLADES! OPPLADBARE BATTERIER SKAL TAS UT AV LEKEN FØR DE OPPLADES! OPPLADBARE BATTERIER SKAL KUN OPPLADES UNDER TILSYN AV EN VOKSEN PERSON! SØRG FOR AT BATTERIENE VENDER RIKTIG VEI NÅR BATTERIENE SETTES INN! MAN MÅ IKKE BRUKE BATTERIER AV ULIK TYPE ELLER NYE OG BRUKTE BATTERIER SAMTIDIG! BRUKTE BATTERIER SKAL IKKE KASTES I HUSHOLDNINGSAVFALLET, MEN LEVERES INN TIL SPESIELLE INNSAMLINGSSTEDER ELLER TIL ET DEPONI FOR SPESIALAVFALL.

(DK) Dette legetøj må kun benyttes sammen med batterier af typen R03/LR03/AAA! Kontrollér med jævne mellemrum, at batterierne ikke er flade! Svage batterier tages ud af legetøjet! Husk, at engangsbatterier ikke må oplades! Genopladelige batterier tages ud af legetøjet, inden de oplades! Genopladelige batterier må kun oplades under opsyn af voksne personer! Sørg for, at batterierne lægges i med korrekt polaritet! Uensartede batterityper eller nye og brugte batterier må ikke benyttes sammen! Brugte batterier skal afleveres på de gængse opsamlingssteder eller på et særdepot for problemaffald. Må ikke kommes i affaldsposen!

(S) DEN HÄR LEKSÅKEN FÅR BARA DRIVAS MED BATTERITYP R03/LR03/AAA! KONTROLLERA REGELBUNDET OM BATTERIERNAS HÅLLER PÅ ATT TA SLUT! TA UT FÖRBRUKADE BATTERIER UR LEKSÅKEN! EJ LADDNINGSBARA BATTERIER FÅR EJ LADDAS! TA UT LADDNINGSBARA BATTERIER UR LEKSÅKEN INNAN DE LADDAS! LADDA BARA LADDNINGSBARA BATTERIER UNDER VUXNA PERSONERS UPPSIKT! LÄGG I BATTERIERNAS MED RÄTT POLARITET! OLIKA BATTERITYPEN ELLER NYA OCH ANVÄNDA BATTERIER FÅR EJ ANVÄNDAS TILLSAMMANS! SLÄNG INTE FÖRBRUKADE BATTERIER I HUSHÅLLSSOPORNA, UTAN LÄMNA DEM ENDAST PÅ BEFINTLIGA UPPSAMLINGSPLATSER ELLER PÅ PLATS FÖR SPECIALSOPOR.

(FIN) TÄTÄ LEIKKIKALUA SAA KÄYTTÄÄ VAIN R03/LR03/AAA PARISTOILLA! TARKISTA SÄÄNNÖLLISESTI, ETTÄ PARISTOT EIVÄT VUODA! POISTA KULUNEET PARISTOT LEIKKIKALUSTA! LADATTAVAKSI SOPIMATTOMIA PARISTOJA EI SAA LADATA! POISTA LADATTAVAT PARISTOT LEIKKIKALUSTA ENNEN LATAUSTA! LADATTAVIEN PARISTOJEN LATAUS ON LUVALLISTA VAIN AIKUISTEN VALVONNAN ALLA! ASETÄ PARISTOT SISÄÄN NIIN, ETTÄ NIIDEN NAPAISSUUS ON OIKEIN! ERILAISTEN PARISTOMALLIEN TAI UUSIEN JA KÄYTETTYJEN PARISTOJEN KÄYTTÖ YHDESSÄ ON KIELLETTY! ÄLÄ HEITÄ KÄYTETTYJÄ PARISTOJA TALOUSJÄTTEIDEN JOUKKOON, VAAN TOIMITA NE ASIANMUKAISIIN KERÄYSKOHTEISIIN TAI ERIKOISJÄTTEIDEN VASTAANOTTOPIIKKAAN.

(GR) Να χρησιμοποιείτε μόνο μπαταρίες του τύπου που σας υποδεικνύουν οι πληροφορίες ή αντίστοιχες. Ποτέ μην επαναφορτίσετε μη επαναφορτιζόμενες μπαταρίες. Οι επαναφορτιζόμενες μπαταρίες πρέπει να επαναφορτίζονται πάντα από ενήλικα. Αφαιρείτε τις επαναφορτιζόμενες μπαταρίες από την ηλεκτρονική μονάδα του παιχνιδιού πριν τις επαναφορτίσετε. Μην συνδυάζετε μπαταρίες διαφορετικών τύπων, π.χ. αλκαλικές ή επαναφορτιζόμενες με απλές, ή παλιές με καινούργιες. Τοποθετείστε τις μπαταρίες με την σωστή πολικότητα. Όταν αδειάζουν οι μπαταρίες πρέπει να απομακρύνονται από το παιχνίδι. Ποτέ μη βραχυκυκλώνετε τους πόλους. Πάντα να ελέγχετε τις μπαταρίες για τυχόν διαρροές. Μην πετάτε ποτέ στα οικιακά απορρίμματα τις παλιές μπαταρίες, παρά μόνο σε ειδικούς κάδους ανακύκλωσης με την αντίστοιχη ένδειξη. Για τον κατάλληλο τρόπο ανακύκλωσης, παρακαλούμε επικοινωνήστε με τους τοπικούς φορείς.

30 89 3942



30 22 0160



30 89 3932



30 89 4402

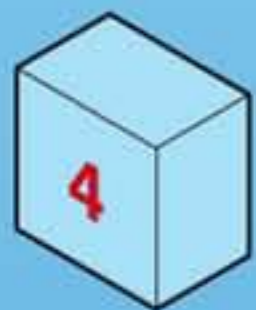
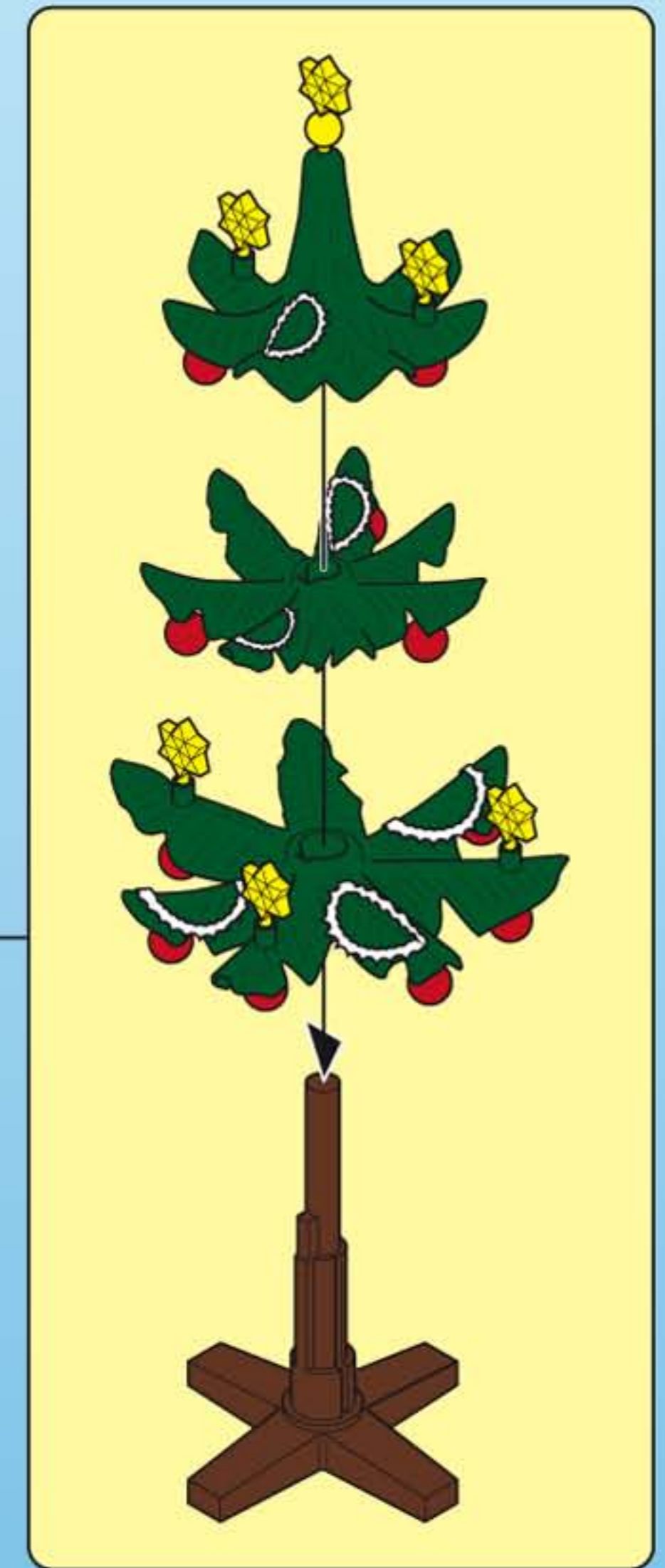

30 89 4022

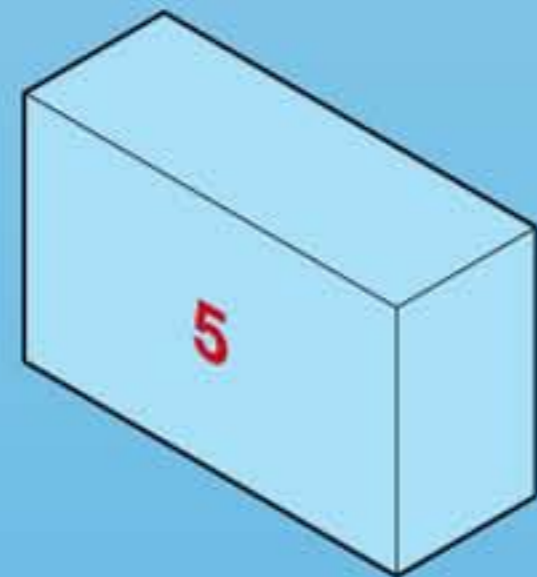

30 89 4032

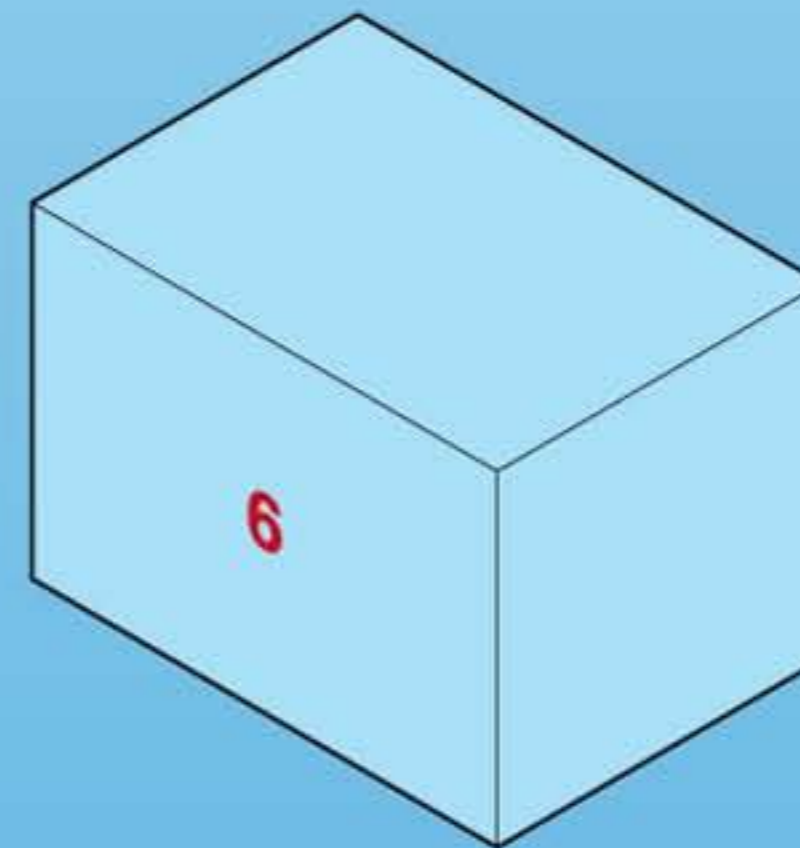

30 89 4042

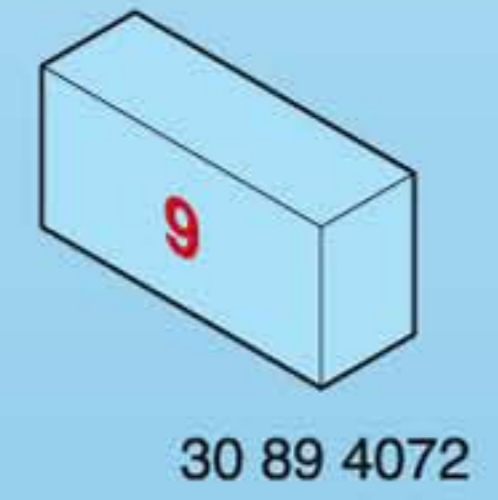
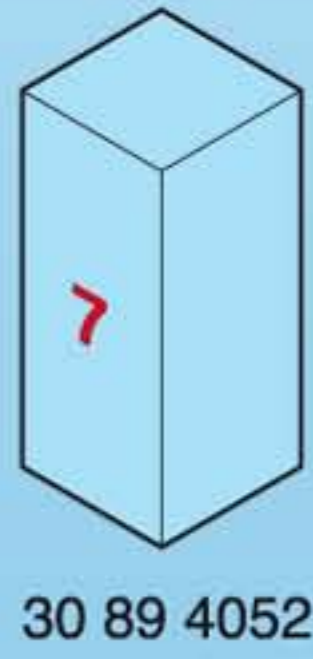
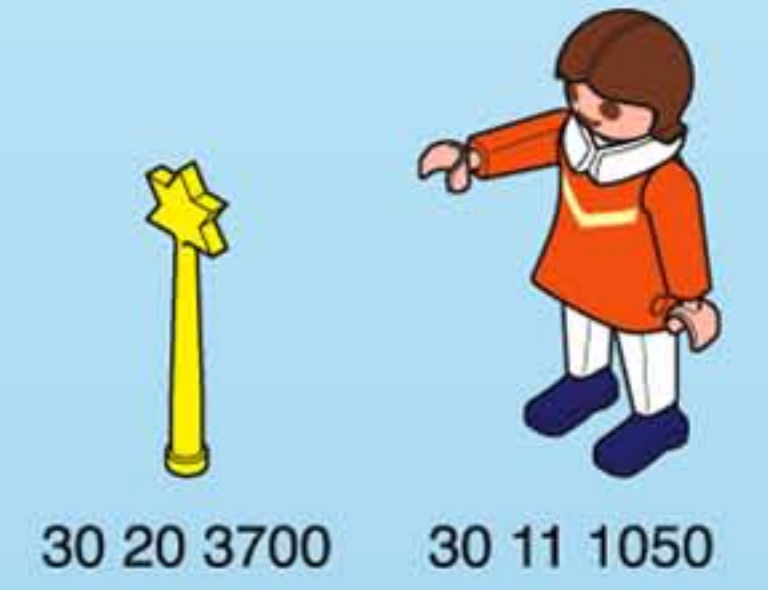



30 89 4232



30 21 0940



30 10 1580

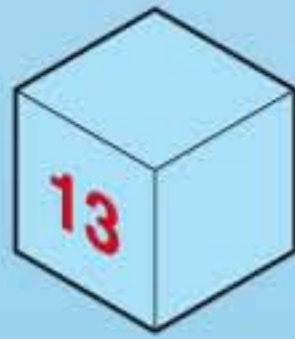

30 89 4112



30 89 4122



30 89 9830



30 89 3952



30 24 0130



30 08 3920



30 61 5950



30 24 2180

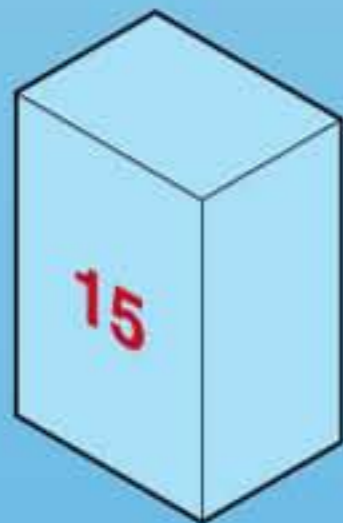

30 89 4132



30 89 4142



30 07 3680



30 14 2260



30 61 5950

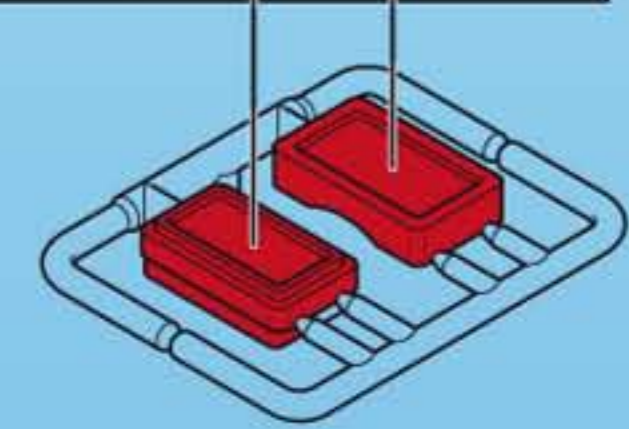

30 60 2740



30 89 4152

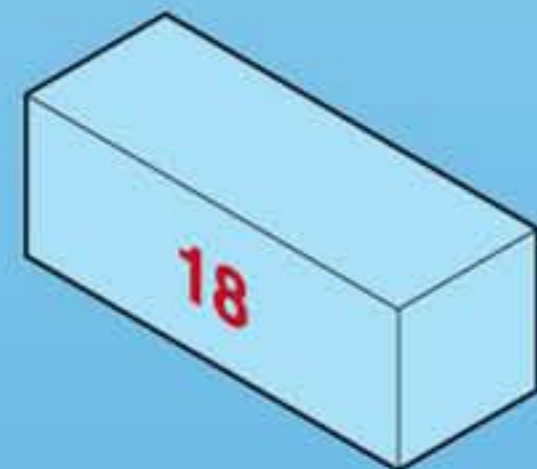

30 89 4162



30 89 4172



30 89 4182

30 07 3840



30 08 1270



30 64 5060



30 09 3920



30 22 7770

2x 30 22 7700

30 62 2510

30 00 9520



30 89 4192



30 89 4202



30 89 4212



30 89 4222

30 89 3982

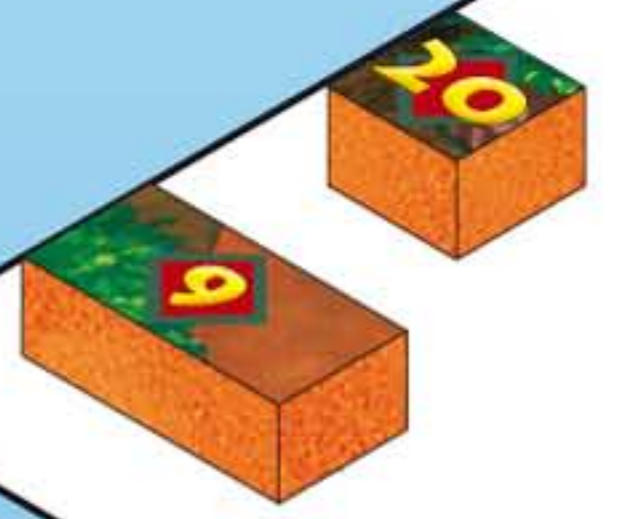
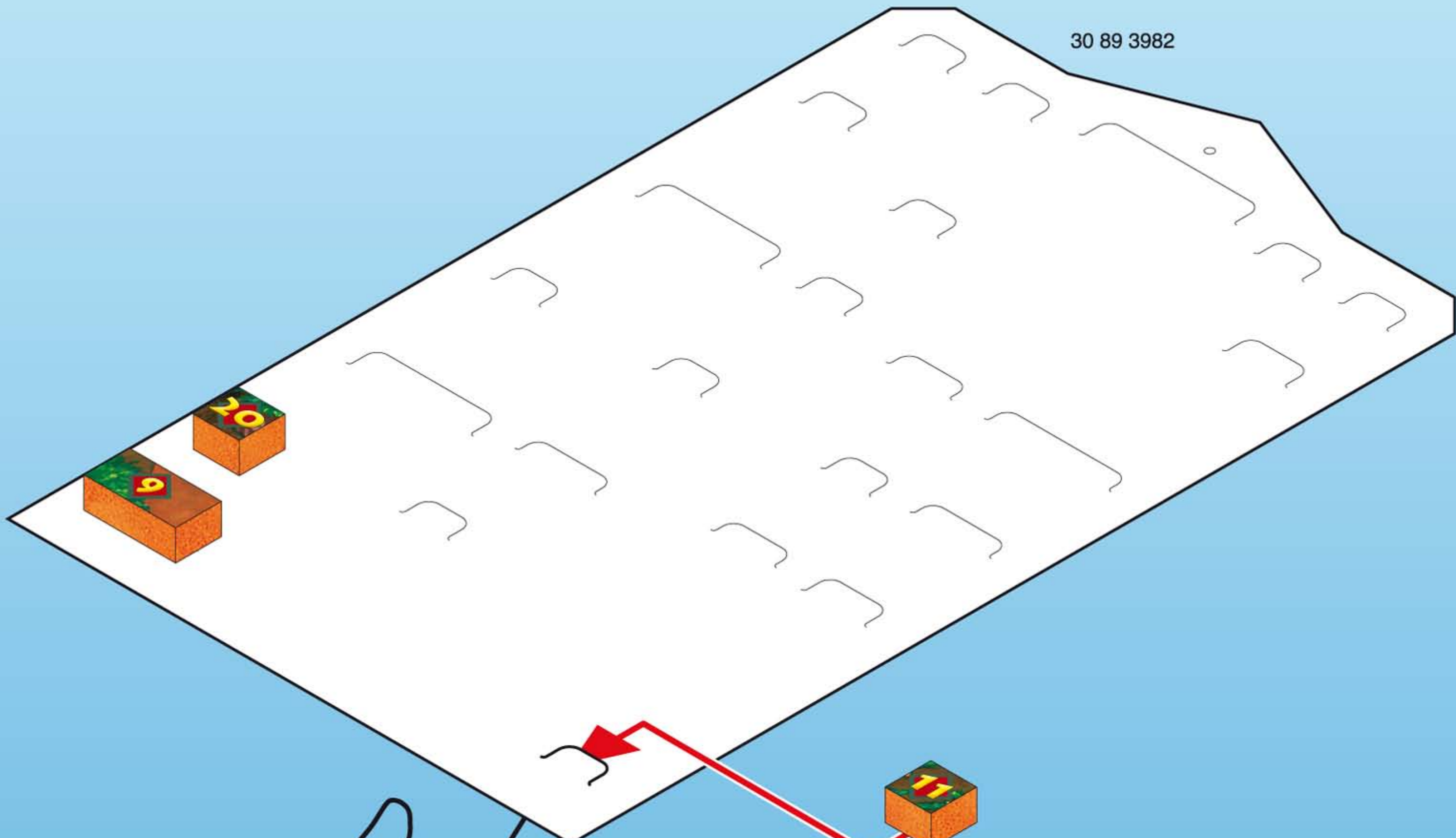

1

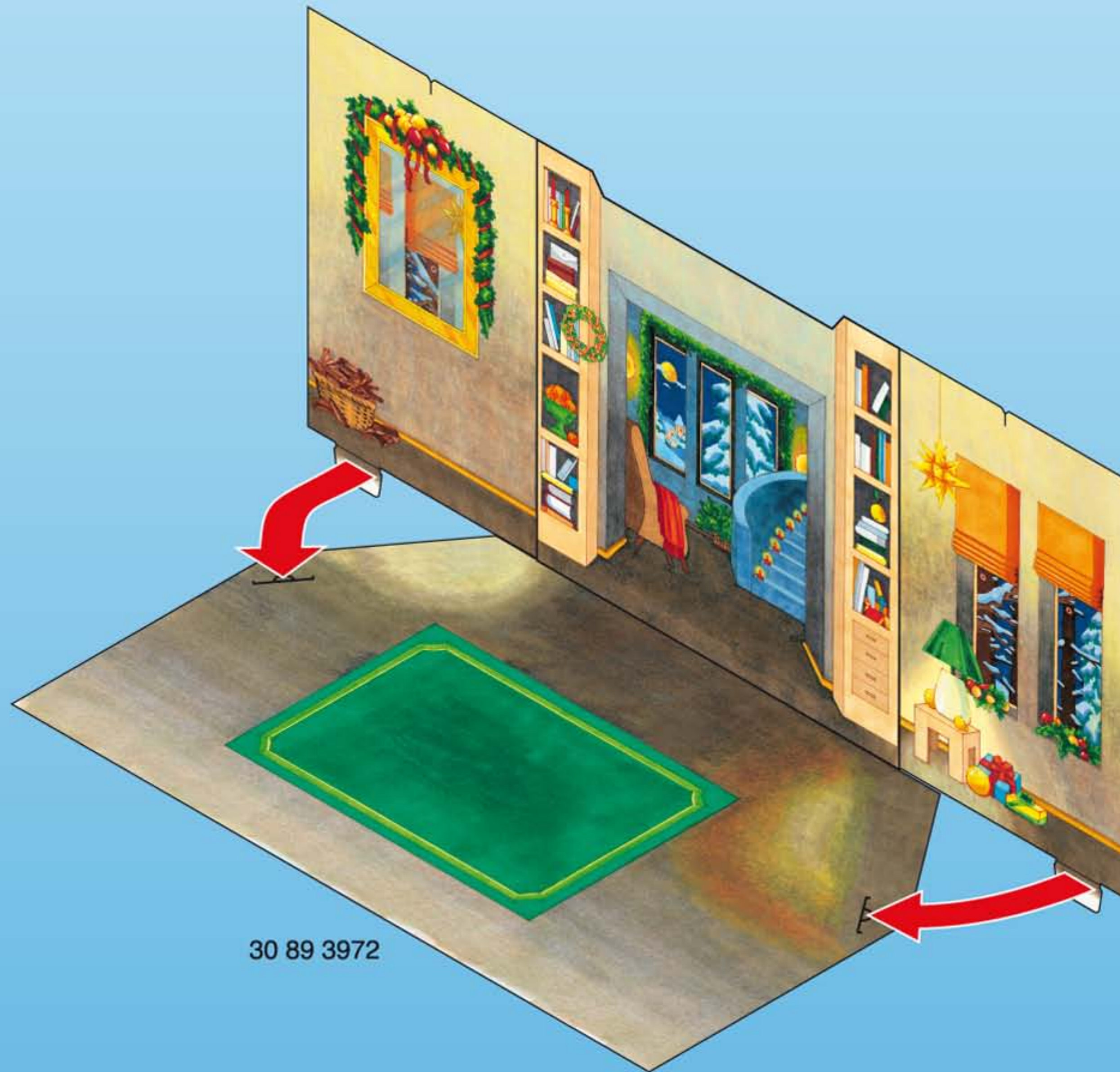

30 89 3972

2



30 89 7062

Serviceadressen finden Sie in
allen Playmobil-Prospekten

Addresses of Customer Service
Departments are shown in all
Playmobil catalogues

L'adresse du service
consommateurs est indiquée
dans tous les catalogues
Playmobil

Troverete gli indirizzi dei centri di
assistenza in tutti i cataloghi Playmobil

Las Direcciones de los Departamentos de
Servicio al Consumidor se encuentran
en todos los catálogos Playmobil

Η διεύθυνση του Γραφείου Εξυπηρέτησης
Πελατών είναι καταχωρημένη σε όλους τους
καταλόγους Playmobil

pronounce: plāy-mō-bēēl